

Operating Manual E30 Series

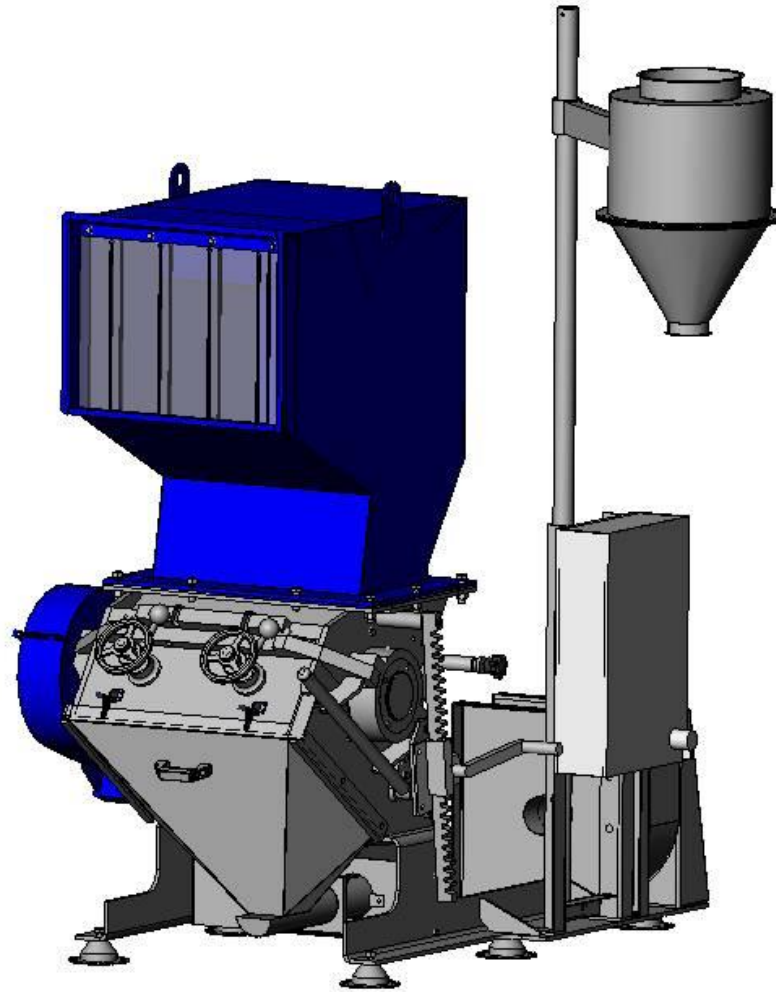

Virtus
The Right Machine for
Today's Recycling Requirements

Virtus Equipment
311 Era Drive
Northbrook IL 60062

Phone: +1-847-291-1800

Sales@Virtus-Equipment.com

www.Virtus-Equipment.com

ORIGINAL INSTRUCTION

PART A: Basic machine

Granulator E 30 Series

Table of Contents

1	Information on this instruction manual	6
2	Technical data	7
3	General Information	10
3.1	Copyright	10
3.2	Application	10
3.3	Safety	10
3.4	Inspection of goods	10
4	General safety advice	11
4.1	Safe operation of the machine	11
4.2	Use in accordance with the regulations	12
4.3	Liability and Responsibility	14
4.4	Structural changes, spare parts, accessories	15
4.5	Operation manuals from other manufacturers	15
4.6	Noise levels and noise control measures	16
4.7	Work stations	16
4.8	Remaining risks	17
4.8.1	Mechanical dangers	17
4.8.2	Electrical dangers	19
4.8.3	Dangers caused by the control system	19
4.8.4	Thermal dangers	20
4.8.5	Dangers caused by noise	20
4.8.6	Dangers caused by vibration	20
4.8.7	Dangers caused by materials and substances	21
4.8.8	Danger caused by manipulation of the protective devices	21
4.9	Protective devices	Error! Bookmark not defined.
4.9.1	Safety device for housing upper section and lower section	Error! Bookmark not defined.
4.9.2	Opening hopper and machine upper section	24
4.10	"V"-belts, disk flywheels and shaft protector	24
4.10.1	Rotor lock	26
4.10.2	Splash guard	27
4.10.3	Safety markings	27
4.11	Authorized persons	28
4.12	Personal protective gear	29
4.13	Safety measures at the application site	30
4.14	Fire fighting agents	30
4.15	Cleaning agents	30
4.16	Conduct in case of an emergency	30
4.17	Classification of specific safety advice	31
5	Description of the machine	32
5.1	Grinding material in feed	32

ORIGINAL INSTRUCTION

PART A: Basic machine

Granulator E 30 Series

5.1.1	In feed hopper	32
5.1.2	Additional in feed device	33
5.2	Base frame E 30/30, /60 and /100	34
5.3	Drive	35
5.4	Granulator upper section	36
5.5	Granulator lower section	37
5.5.1	Rotor and cutting knives	37
5.5.2	Screen and screen support	39
5.6	Manual opening devices (only E 30/30, /60 and /100)	40
5.7	Discharge of grinding material	41
5.7.1	E 30/30 and 30/60	41
5.7.2	E 30/100	Error! Bookmark not defined.
5.8	Housing design	43
6	Initial startup	44
6.1	General Advice	44
6.2	Requirements at the application site	44
6.3	Unloading and installing the machine	45
6.4	Electrical connection	46
6.5	Machine check prior to initial start-up	48
7	Operation	49
7.1	Machine checks before switching on the machine	49
7.2	Switch on machine	49
7.3	Switch off machine	50
7.4	Manual in feed of grinding material	50
8	Maintenance	51
8.1	Safety advice	51
8.2	Maintenance plan	51
8.3	Checking the protective devices	52
8.4	Open and close the granulator (E 30/30, /60 and /100)	53
8.4.1	Opening the granulator upper section	53
8.4.2	Closing the granulator	54
8.5	Replacing the screen (E 30/30, /60 and /100)	55
8.6	Cleaning the machine	56
8.7	Replacing the main bearings	57
8.7.1	Dismounting the main bearings	57
8.7.2	Mounting the main bearing	58
8.8	Lubricating the main bearings	59
8.8.1	Lubrication intervals:	59
8.8.2	Check lubricant quality	59
8.8.3	Replacing or refilling lubricant	59
8.8.4	List of lubricants	61

ORIGINAL INSTRUCTION

PART A: Basic machine

Granulator E 30 Series

8.9	Mounting and dismounting TAPER-LOCK tensioning element	62
8.9.1	Table for the tightening torque of the screws	62
8.9.2	Mounting the TAPER-LOCK tensioning element	63
8.9.3	Dismounting the TAPER-LOCK tensioning element	63
8.10	Work on the "V"-belts	64
8.10.1	Checking the tension force of the "V"-belt	64
8.10.2	Retensioning and relaxing the "V"-belt	65
8.10.3	Checking "V"-belt condition, replacing "V"-belt	65
8.11	Working on the cutting knives	66
8.11.1	Replacing and checking the cutting knife mountings	66
8.11.2	Checking the condition of the cutting knives	67
8.11.3	Dismounting the cutting knives	68
8.11.4	Mounting the cutting knives	69
8.11.5	Sharpening cutting knives	70
8.11.6	Setting the cutting knives	73
8.11.7	Transporting and storing the cutting knives	75
9	Troubleshooting	76
9.1	Machine blocks or switches itself off	76
9.2	Rotor does not grip bulky material	76
9.3	Overheating of the grinding material	76
9.4	Unusual vibrations	77
9.5	Extreme cutter wear	77
9.6	Bearings too hot	77
9.7	Too many fines in grinding material	77
9.8	Cutting gap alters during operation	77
9.9	Screen damage	78
9.10	Granulator does not start	78
9.11	Granulator blocks when under load	78
9.12	Frequent switching off of grinding material in feed device	78
10	Storage, disposal, transportation	79
10.1	Storage	79
10.2	Disposal	79
10.3	Transportation	79
11	Hydraulic MAINTENANCE	80
12	Customer service and spare parts orders	82

ORIGINAL INSTRUCTION
PART A: Basic machine
Granulator E 30 Series

13	Spare Parts List	83
13.1	E 30/30	Error! Bookmark not defined.
13.2	E 30/60	Error! Bookmark not defined.
13.3	E 30/100	Error! Bookmark not defined.
14	CIARIFICATION FOR PERSONal TRAINING	94
15	Electrical Connection	95
16	DIMENSIONS OF STANDARD MACHINE	96
16.1	E 30/30	Error! Bookmark not defined.
16.2	E 30/60	Error! Bookmark not defined.
16.3	E 30/100	Error! Bookmark not defined.
17	ADDITION	99

1 INFORMATION ON THIS INSTRUCTION MANUAL

Author: VIRTUS Equipment

No part of this operation manual may be reproduced, distributed or used in any shape or form, stored in a data processing system or translated into another language without written permission.

This operation manual serves to help you to get to know your machine and how to make use of its application possibilities in accordance with the regulations.

The operation manual contains important information on how to operate the machine safely, correctly and economically. Following this advice will help you to avoid danger, minimize repair costs and down times and to increase the reliability and durability of the machine.

Before you begin to work on and with the machine, please read the operation manual thoroughly. Only after you have read and understood the contents of this operation manual may you begin work on and with the machine. Keep this operation manual at the application site for future reference.

References to chapters, plans and other documents as well as key markings are written in *italics*.

↓ Instructions on handling are marked in this way.

The machine is designed in modular system and offers a wide spectrum of variations to do justice to your expectations. In order that you receive with the delivery of your machine all the information relevant for you, this operation manual is divided into three parts:

1. Part A: Information of the basic machine.
2. Part B: Plans, operation manuals for systems from other manufacturers etc.

Should you wish to order further operation manuals, please quote the machine number.

We wish you every success with your new machine!

ORIGINAL INSTRUCTION
PART A: Basic machine
Granulator E 30 Series

2 TECHNICAL DATA

E 30/30

Feed opening	Data in mm:	460x300
Rotor dimension:	Diameter in mm:	300
	Width of cut in mm:	300
Rotor type F3	3-knives-version	
Rotor knives:	Rows of knives:	3
	No. of rotor knives:	3
Stator knives:	No. of bed knives:	2
Rotor speed (50 Hz):	rpm	521
Width:	Data in mm:	1100
Length:	Data in mm:	1660
Height:	Data in mm:	1900
Drive motor:	Power in kW:	7,5; 11
Screen:	Type and screen hole size dependent on the application and customer requirements.	
Opening device:	Standard	Handwinch
Machine weight:	In kg	
Electrical connection data:	markings are attached to the machine	
Noise level: Depends on plant location and type of grinding material !	Without noise equipment, in dB(A):	ca. 90
	With noise equipment in dB(A):	< 85
Dimensions:	See Layout <i>drawing</i>	

ORIGINAL INSTRUCTION
PART A: Basic machine
Granulator E 30 Series

E 30/60

Feed opening	Data in mm:	460x590
Rotor dimension:	Diameter in mm:	300
	Width of cut in mm:	590
Rotor type F3	3-knives-version	
Rotor knives:	Rows of knives:	3
	No. of rotor knives:	3 x 2
Stator knives:	No. of bed knives:	2
Rotor speed (50 Hz):	rpm	521
Width:	Data in mm:	1380
Length:	Data in mm:	1700
Height:	Data in mm:	1900
Drive motor:	Power in kW:	11; 15; 18.5
Screen:	Type and screen hole size dependent on the application and customer requirements.	
Opening device:	Standard	Handwinch
Machine weight:	In kg	
Electrical connection data:	markings are attached to the machine	
Noise level: Depends on plant location and type of grinding material !	Without noise equipment, in dB(A):	ca. 90
	With noise equipment in dB(A):	< 85
Dimensions:	See <i>Layout drawing</i>	

ORIGINAL INSTRUCTION
PART A: Basic machine
Granulator E 30 Series

E 30/100

Feed opening	Data in mm:	460x990
Rotor dimension:	Diameter in mm:	300
	Width of cut in mm:	990
Rotor type F3	3-knives-version	
Rotor knives:	Rows of knives:	3
	No. of rotor knives:	3x2
Stator knives:	No. of bed knives:	2
Rotor speed (50 Hz):	rpm	552
Width:	Data in mm:	1620
Length:	Data in mm:	1300
Height:	Data in mm:	1900
Drive motor:	Power in kW:	18.5; 22
Screen:	Type and screen hole size dependent on the application and customer requirements.	
Opening device:	Standard	Handwinch
Machine weight:	In kg	
Electrical connection data:	markings are attached to the machine	
Noise level: Depends on plant location and type of grinding material !	Without noise equipment, in dB(A):	ca. 90
	With noise equipment in dB(A):	< 85
Dimensions:	See <i>Layout drawing</i>	

3 GENERAL INFORMATION

3.1 Copyright

VIRTUS Equipment holds the copyright for these operation instructions, entrusted to the owner of the granulator for his personal use. These contains technical instructions and drawings which are not be copied complete or in part, distributed or used for reasons of unauthorized competition or for informing others.

3.2 Application

The granulator is designed for size-reduction of light plastic material such as PE, PP and PVC etc. The user is responsible for consequences resulting from incorrect operation: This will lead to the loss of the warranty as well as any compensation claims.

3.3 Safety

The granulator has been constructed in accordance to the general standards of technology and is fitted with safety devices to prevent accidents that could endanger the life or health of the operator. The company operating the unit is responsible for the compliance of the safety regulations. We recommend staff training courses at regular intervals subsequent to initial training during commissioning.

3.4 Inspection of goods

The goods must be inspected by the purchaser to ensure that the delivery is complete and free from damage during transport. In the event of any queries VIRTUS must be informed with regard to missing items or transport damage. In the event of actual transport damage, written notification including photographs should be made and sent to the transport company as well as sent to VIRTUS immediately after delivery.

4 GENERAL SAFETY ADVICE

4.1 Safe operation of the machine

The machine is built according to the state of the art and recognised safety regulations.

It is equipped with protective devices; however there is still the threat of danger in case of incorrect conduct or misuse:

- for the health of the operator and that of other persons,
- for the machine,
- for the environment,
- for material assets belonging to the company and the operator.

All persons involved in:

- transportation and storage,
- start-up and shutdown,
- operation,
- setting and fitting
- maintenance and waste disposal...

of the machine must carefully read and take note of the following advice. However, not only the general safety advice listed in this chapter has to be observed, but also the safety advice which is added specifically in the other chapters.

Failure to heed this safety advice can lead to loss of all compensation claims.

Furthermore, the existing rules and regulations for the prevention of accidents as well as in house company working, operational and safety regulations have to be observed.

4.2 Use in accordance with the regulations

The operational safety of the delivered machine is only guaranteed for use in accordance with the regulations!

This regulation use is only achieved if the following points are observed and fulfilled.

Manufacturing process and grinding material

The granulator is suitable exclusively for the grinding of light material, which corresponds to the agreed customer-specific specifications in all points (see *Contract of sale*).

Any other work or design will differ from the specified requirements. VIRTUS Equipment will not be held responsible. The specified requirements also include all information found in the owner's manual such as maintenance and service.

Any change in the specifications or requirements must be brought to the attention of VIRTUS.

Suction unit

If emissions occur during grinding of material, which exceed the permissible legal values for contaminants in the air, the granulator may only then be operated when the customer on site has installed a suitable air suction device.

Safety device for the in feed hopper

In the case that your design of granulator does not contain any additional in feed device (e.g. nip roll feed device), the in feed hopper must be safeguarded in a suitable way against persons reaching in or falling in.

Connection of the Emergency Stop button

The machine may only be operated with the installed Emergency Stop buttons. In case no Emergency Stop buttons have been installed, an Emergency Stop button must be mounted on the control cabinet, the second on the material in feed.

ORIGINAL INSTRUCTION

PART A: Basic machine

Granulator E 30 Series

Miscellaneous:

- The working conditions and instructions specified in this operation manual must be adhered to.
- The machine is not suitable for operation in an explosive environment.
- Faults, which can impair safety, are to be reported immediately and eliminated by a trained and skilled specialist.
- The machine may only be used in the industrial application range.

General Requirements Safety Information

- The service and maintenance in this owner's manual must be performed on a regular basis.
- The machine is not designed for operation in a volatile environment.
- Faults that could be a safety factor must be reported immediately and repaired by experienced personal.
- The machine must only be installed in a production type building.

Known uses not in accordance with the regulations

Never grind grinding materials, which do not correspond to the agreed customer-specific specifications. If this occurs, there is a danger to persons and the possibility of the machine being damaged.

Informal Safety Requirements

The owner's manual should always be located near the machine. New excerpts or additions to the owners' manual must always be replaced to include any safety requirements or environmental requirements.

All safety or caution signs must be visual and easy to read.

ORIGINAL INSTRUCTION
PART A: Basic machine
Granulator E 30 Series

4.3 Liability and Responsibility

The General Conditions of Sale and Delivery basically apply. These conditions apply no later than the end of the contract. Liability and or responsibility to seller do not apply to the following;

- Equipment is not properly used for its specific application.
- Non-conforming installation, commissioning or service of the machines.
- Operation of the equipment without proper safety guards.
- Not conforming to the directions of the owners' manual regarding transport, storage, installation, commissioning or servicing the equipment.
- Any designs alterations on the machine.
- Any changes on the program logic which can alter the machine operation or electrical function.
- Changes in the logic function.
- In proper maintenance or serving the machines that can lead to extraordinary wear
- In proper serving of equipment
- Spontaneous crashes caused by foreign objects falling into the machine or acts of God

We honour a 6 month guarantee valid after delivery under the conditions that originally delivery or original parts from VIRTUS Equipment are used or accepted for use in accordance with our owners manual.

Otherwise the guarantee will be considered invalid. Excluded are wear and tear parts such as knives, screens, drive belts, bearings, etc.

4.4 Structural changes, spare parts, accessories

For reasons of safety, remodelling and modifications to the machine, in particular to the electrical devices, are only permissible by arrangement with the manufacturer!

Replace faulty parts immediately. Only use original spare parts or spare parts from other manufacturers, which correspond, to the original spare parts with regards to function, stress and safety. This applies in particular for reasons of EMC (electro-magnetic compatibility) for electrical components. If parts are replaced which are relevant for safety, they must be checked afterwards for proper functioning.

Only use accessories, which have been approved by the manufacturer. Use of accessories can change work with the machine. You must therefore observe the additional advice for your work and your safety. Read *Part B: Accessories*, before you commission the machine.

4.5 Operation manuals from other manufacturers

Integrated in the machine are systems from other manufacturers. When working on or with these systems, please observe the advice in the operation manuals from the respective manufacturer. These operation manuals are enclosed with the machine documentation.

4.6 Noise levels and noise control measures

The GSE series granulator standard design is without a sound proof enclosure.

The noise level of the granulator at idle speed is approximately 90 dB (A).

Especially by rigid materials soundproofing is recommended due to a noise level of up to 120 dB (A) when in operation.

In order not to exceed the noise level of 90 dB (A) is the purchaser required to provide soundproofing.

The noise level can be affected by foundation static or dynamic, aux. blowers etc. or other additional equipment. Therefore it is necessary to actually determine if the noise level is directly coming from the machine or accessory equipment.

VIRTUS Equipment offers the following equipment to reduce the noise levels;

- C series Granulators



CAUTION

The user or purchaser is responsible for compliance with the instructions and procedures!

4.7 Work stations

During normal operation, the work station is the station at the in feed of the grinding material.

For maintenance work, the whole area around the machine is at your disposal.

ORIGINAL INSTRUCTION
PART A: Basic machine
Granulator E 30 Series

4.8 Remaining risks

The machine is constructed so that you are able to operate it safely. Structurally non-avoidable dangers are prevented as well as possible by the protective devices. A certain remaining risk does however always remain! Being aware of these remaining risks of the machine will help you to structure your work more safely and in so doing to avoid accidents.

To avoid danger, please observe in addition the specific safety advice in the individual chapters.

4.8.1 Mechanical dangers

Type of danger:	Danger of crushing by heavy parts falling down or falling over.
Activity:	Unloading and transporting the machine or machine components.
Possible consequences:	Serious injury could result.
Preventative measures:	Wear personal protective gear. Follow the instructions in this <i>Operation manual</i> .

Type of danger:	Danger of cutting caused by sharp cutting knives, even when the rotor is stationary.
Activity:	Knife replacement, knife setting, and knife sharpening, other maintenance work.
Possible consequences:	Serious injury, particularly to hands and fingers can result.
Preventative measures:	Wear personal protective gear. Follow the instructions in this <i>Operation manual</i> .

Type of danger:	Danger of crushing when closing the granulator upper section.
Activity:	Maintenance work.
Possible consequences:	Serious injury can result.
Preventative measures:	When closing the granulator upper section, ensure that no persons are in the danger area.

Type of danger:	Tripping over cables and other objects lying around.
Activity:	All activities.
Possible consequences:	Serious injury can result.
Preventative measures:	Lay cables in accordance with the regulations. Keep work station clean and tidy.

ORIGINAL INSTRUCTION
PART A: Basic machine
Granulator E 30 Series

Type of danger:	Danger of crushing, cutting and amputation caused by up to 3 minute run down of the rotor.
Activity:	Maintenance work.
Possible consequences:	Serious injury or death can result.
Preventative measures:	The housing upper section must always be tightly locked during operation using the connecting screws. Do not make the run down safety devices ineffective by using technical aids or other manipulations. Never check by hand whether the rotor has come to a stop.

Type of danger:	Danger of pulling in caused by running "V"-belts.
Activity:	All activities.
Possible consequences:	Hair, jewellery etc. can be pulled into the machine. Serious injury can result.
Preventative measures:	Never dismount "V"-belt protection and window.

ORIGINAL INSTRUCTION
PART A: Basic machine
Granulator E 30 Series

4.8.2 Electrical dangers

Danger:	Direct or indirect contact with live parts in the terminal box.
Activity:	Maintenance work, start-up.
Possible consequences:	Serious injury or death.
Preventative measures:	<p>Trained electricians may only carry out all work on the electrical equipment.</p> <p>If work is necessary on parts, which conduct dangerous voltage, a second person should be called in who can break the power supply in case of emergency.</p> <p>The yellow-marked lines conduct voltage even when the machine is switched off (main switch to 0).</p> <p>Only use original safety fuses with stipulated intensity of current.</p> <p>Faulty electrical components must be replaced immediately.</p> <p>If faults occur in the electrical energy supply, switch machine off immediately.</p> <p>The terminal box must be locked during operation. Before opening the terminal box: Main switch to 0.</p>

4.8.3 Dangers caused by the control system

Type of danger:	Danger caused by failure of the Emergency Stop function.
Activity:	All activities.
Possible consequences:	Serious injury or death.
Preventative measures:	It must be guaranteed that failure of an Emergency Stop button is displayed and leads to an immediate stop of the machine.

ORIGINAL INSTRUCTION
PART A: Basic machine
Granulator E 30 Series

4.8.4 Thermal dangers

Type of danger:	Danger of fire and explosion caused by throwing dangerous objects (e.g. spray cans) into the granulator.
Activity:	Grinding.
Possible consequences:	Serious injury or death can result.
Preventative measures:	Only grind grinding material, which corresponds to the agreed customer-specific specifications in all points.

4.8.5 Dangers caused by noise

Type of danger:	Damage to hearing.
Activity:	All activities.
Possible consequences:	Diminished hearing, headaches, impaired balance, and deterioration of concentration.
Preventative measures:	Reduce noise emissions by taking suitable measures. Wear ear protection.

4.8.6 Dangers caused by vibration

Type of danger:	Instability of the granulator caused by vibration.
Activity:	All activities.
Possible consequences:	Serious injury can result.
Preventative measures:	Install the machine according to the instructions of this <i>Operation manual</i> and the <i>Assembly drawing</i> .

Type of danger:	Loosening of the cutting knife mountings caused by vibration.
Activity:	All activities.
Possible consequences:	Serious injury can result.
Preventative measures:	Check the cutting knife mountings regularly according to the instructions in this operation manual.

ORIGINAL INSTRUCTION
PART A: Basic machine
Granulator E 30 Series

4.8.7 Dangers caused by materials and substances

Type of danger:	Inhalation of grinding dust.
Activity:	All activities.
Possible consequences:	Diseases of the respiratory tract etc.
Preventative measures:	Mount a suitable air suction device. Wear breathing equipment if necessary. When cleaning the machine do not blow out grinding dust, use suction instead.

4.8.8 Danger caused by manipulation of the protective devices

Type of danger:	Danger of crushing, cutting and amputation.
Activity:	All activities.
Possible consequences:	Serious injury or death can result.
Preventative measures:	Never make the protective devices ineffective. Check the protective devices regularly for proper functioning according to the specifications given in this operation manual.

ORIGINAL INSTRUCTION

PART A: Basic machine

Granulator E 30 Series

4.9 Protective devices

The machine may under no circumstances be operated without these protective devices or with faulty or manipulated protective devices. The threaded spindles of the run down safety devices may only be rotated by hand.

4.9.1 Safety device for suction trough and screen holder

Illustration:
Safety device



The granulator can only be operated if the front door is closed. The safety switch for the front door has a guard locking and can be only opened after the key switch “Door Open” at the panel is activated. The electrical time delay prevents that the machine can be opened before the machine comes to shutdown.

ORIGINAL INSTRUCTION

PART A: Basic machine

Granulator E 30 Series

4.9.2 Safety device for upper section

Illustration:

Safety device upper housing

- (1) Safety switch
- (2) Housing lock

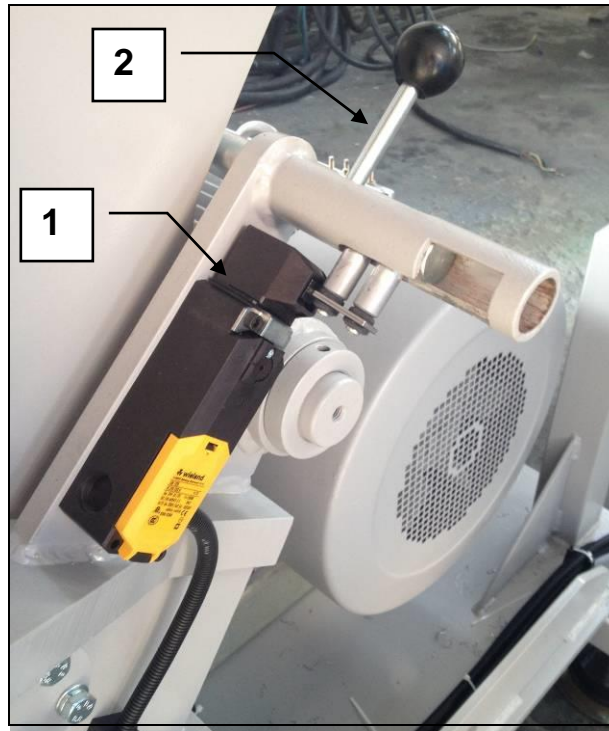

The granulator upper section can be opened by means of a hand wrench. Before opening the housing lock by hand to free the upper housing section.

The housing lock can be only opened after the key switch “Door Open” at the panel is activated. The electrical time delay prevents that the machine can be opened before the machine comes to shutdown.

ORIGINAL INSTRUCTION

PART A: Basic machine

Granulator E 30 Series

4.9.3 Opening hopper and machine upper section

Illustration:
Opened hopper/
upper section



Illustration:
Hand winch



The upper section of the machine with the hopper can be opened with the mounted hand winch.

4.10 "V"-belts, disk flywheels and shaft protector

"V"-belt protection, disk flywheel protection (insofar as a disk flywheel is present) and shaft protector are fixedly connected to the machine. They can be dismantled for installation and maintenance work. However, this may only then be carried out

ORIGINAL INSTRUCTION
PART A: Basic machine
Granulator E 30 Series

when all rotating parts have come to a complete standstill.

Illustration:
V-belt cover with safety
switch

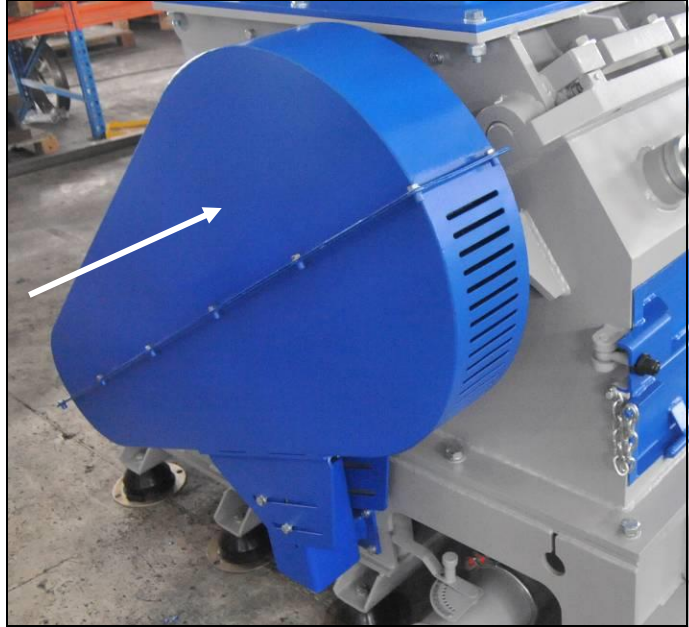

If machines are delivered on the request of the customer without drive motors, the operator is obliged to fit and mount the protective devices delivered together with the machine himself in line with the current legal safety regulations.

ORIGINAL INSTRUCTION

PART A: Basic machine

Granulator E 30 Series

4.10.1 Rotor lock

Illustration:
Rotor Lock

- (1) Interlock
- (2) Looking disc
- (3) Safety switch for interlock

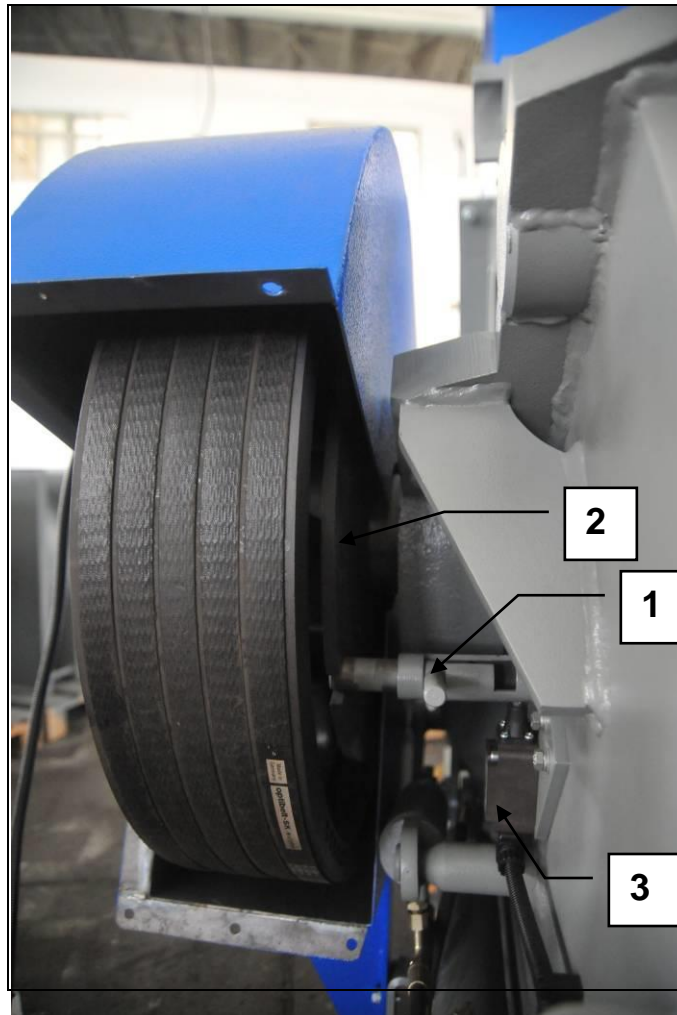

To secure the rotor against turning by knife change or other maintenance work, move the security interlock into the looking disc, which is mounted to the pulley.

The interlock is secured by a safety switch what will provide a damage to the lock caused by starting the machine

ORIGINAL INSTRUCTION

PART A: Basic machine

Granulator E 30 Series

4.10.2 Splash guard

In case that the grinding material is introduced directly via the in feed hopper, the input opening is provided with a splash guard.

Illustration:
Hopper splash guard



Attention:

Fixation of the splash guard curtains must be checked every month.

4.10.3 Safety markings

Safety markings are attached to the machine. If one of these markings becomes detached or is no longer recognisable, it must be replaced. You can order new markings at specialist shops or from us.

ORIGINAL INSTRUCTION

PART A: Basic machine

Granulator E 30 Series

4.11 Authorized persons

Authorized personnel may only carry out work on the machine. Observe the legally permissible minimum age!

As a basic rule, persons who have received training on the machine may only operate the machine.

Personnel, who are still to be trained or receive instruction on the machine, may only work on the machine under constant supervision by an experienced person.

The company operating the machine must make the operation manual accessible to the machine user and ensure that he has read and understood it. Only then may he put the machine into operation.

Responsibility for the different jobs on the machine must be clearly established and adhered to. There must be no unclear areas of authority, as this could endanger the safety of the machine user.

If several persons work on the machine, a detailed division of workstations should be set up.

Trained electricians may only carry out all work on the electrical equipment.

Authorized specialist personnel may only eliminate faults on the control system.

All work related to installation, trained specialist personnel having received instruction on the machine might only carry out fittings and maintenance of the machine.

The operator must make sure that only authorized person's work on the machine. He is responsible for the safety of third persons in the working area of the machine.

ORIGINAL INSTRUCTION
PART A: Basic machine
Granulator E 30 Series

4.12 Personal protective gear

Wear close-fitting clothing. Jewellery and hair must be worn so that they cannot be pulled into the machine by moving parts.

The following protective gear must be worn when carrying out the following tasks:

	Safety helmet	Safety boots	Safety gloves	Safety goggles	Ear muffs
Unloading machine.	x	x	x		
Connecting machine.		x			
Operation.		x	x	x	x
Cleaning.		x	x	x	
Maintenance of bearings.		x			
Screen replacement.		x	x		
Maintenance of "V"-belts.		x			
Maintenance of cutting knives.		x	x		
Knife sharpening.		x	x	x	x

If necessary, protect yourself (in addition to the air suction device) with breathing equipment before inhaling substances harmful to the health.

4.13 Safety measures at the application site

Requirements at the application site: see chapter *Initial Start-up*.
The machine must be erected horizontally on a horizontal surface and in a stable manner.

Ensure by means of appropriate in house orders and controls that the environment of the work station is always clean and clear of obstructions.

4.14 Fire fighting agents

In the case of fire, disconnect the power supply of the machine or pull out the mains plug. Extinguish the fire from a distance of several meters using a fire extinguisher suitable for the machine and the grinding material.

4.15 Cleaning agents

Only use suitable cleaning agents to clean the machine and in doing so, the advice of the manufacturer is to be heeded. Please be aware that unsuitable cleaning agents (e.g. thinners) can damage the paint of the machine as well as the cables and plastic parts.

4.16 Conduct in case of an emergency

The machine may only be operated with the installed Emergency Stop buttons. An Emergency Stop button must be mounted onto the control cabinet, the second onto the grinding material in feed.

Emergency Stop:

- ↓ In case of emergency, immediately press one of the *Emergency Stop buttons*.

CAUTION

The EMERGENCY STOP must be activated in all situations whereby injury or damage could result!





Reoperation:



- ↓ Eliminate cause of Emergency Stop.
 - ↓ Unlock *EMERGENCY STOP BUTTON*.
 - ↓ Acknowledge fault.
- The machine is now ready for operation again.



ORIGINAL INSTRUCTION
PART A: Basic machine
Granulator E 30 Series

4.17 Classification of specific safety advice

The specific safety advices in the following chapters of this operation manual are classified as follows:

 DANGER	
	Indicates an immediately threatening danger. If you do not take avoiding action, death or serious injury will result.

 WARNING	
	Indicates a possibly dangerous situation. If you do not take avoiding action, death or serious injury could result.

 CAUTION	
	Indicates a possibly dangerous situation. If you do not take avoiding action, slight or minor injury could result.

This safety advice refers to the remaining risks for certain working steps and helps you to work safely with the machine. In addition to the safety advice above, there are also the hint and the tip.

HINT



Indicates a possibly harmful situation. If you do not take avoiding action, the machine could be damaged.

TIP



Indicates application tips and other particularly useful information.

5 DESCRIPTION OF THE MACHINE

5.1 Grinding material in feed

The grinding material can be fed into the granulator in the following ways:

- Manual in feed of the grinding material directly into the in feed hopper.
- Automatic in feed of the grinding material by means of an additional in feed device (e.g. conveyor belt).

5.1.1 In feed hopper



The grinding material in feed ensues via an in feed hopper, which is formed so that the grinding material can be delivered correctly and safely. A splashguard at the input opening prevents thrown-back parts being able to escape. The grinding material in feed can take place manually or with the help of an additional in feed device.

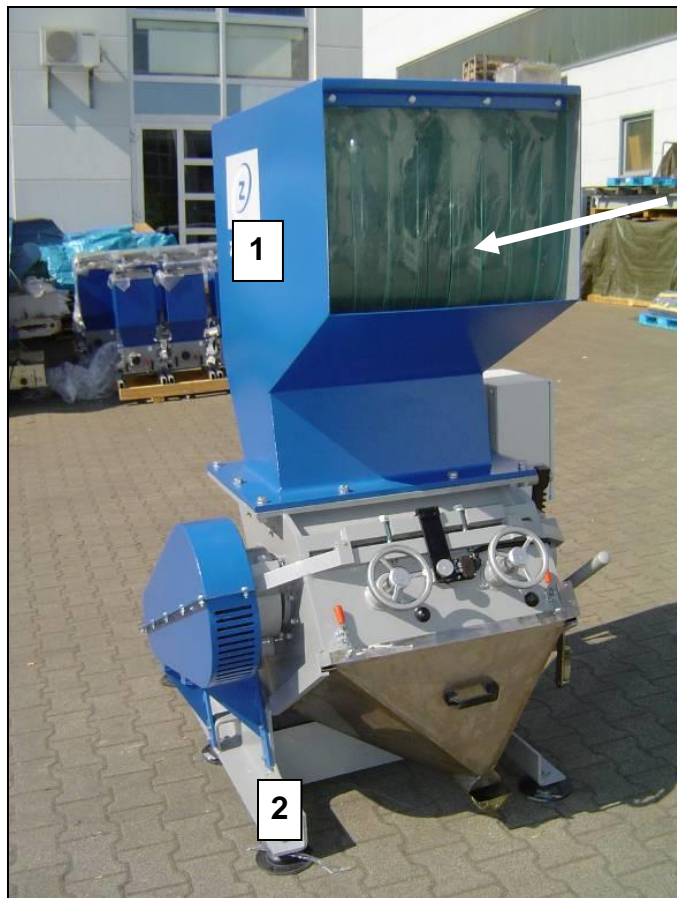

Illustration:

- (1) Standard Infeed hopper
(2) Machine



ORIGINAL INSTRUCTION
PART A: Basic machine
Granulator E 30 Series

 DANGER	
	<p>Material fly back can occur out of the hopper opening. Serious injury or death can result. Do not remove the splash guards from hopper or throw in material larger than the hoppers capacity Splash guards has to be closed during grinding</p>

 WARNING	
	<p>If using a hopper with side infeed or pipe hopper: The material shall be shorter than 80% of the side arms length!</p>

5.1.2 Additional in feed device

If your machine has an optional in feed device such as roller feeder or conveyor belt please refer to the additional information about the accessories in the appendix.

ORIGINAL INSTRUCTION

PART A: Basic machine

Granulator E 30 Series

5.2 Base frame E 30/30, /60 and /100

Illustration:

- (3) Base frame
- (4) Terminal box
- (5) Hand winch
- (6) Drive motor
- (7) Granulator
- (8) Suction trough
- (9) Pads



The machine housing, the suction trough, the drive motor and the hand wrench are mounted on the base frame.

The base frame is equipped with a sufficient number of vibration and noise muffling mounting pads.

ORIGINAL INSTRUCTION
PART A: Basic machine
Granulator E 30 Series

5.3 Drive

The drive of the rotor ensues by means of an electric motor via "V"-belts. The motor, which is mounted on sliding rails or a motor plate, can be adjusted for regulating the tension of the "V"-belts by means of tensioning screws. The "V"-belt pulley is attached with a special tensioning element to the motor shaft.

Illustration:
Drive



Please observe the operation manual from the manufacturer!

ORIGINAL INSTRUCTION
PART A: Basic machine
Granulator E 30 Series

5.4 Granulator upper section

The granulator upper section can be opened or pivoted upwards for maintenance work and for cleaning. It is connected with the granulator lower section by means of a joint. Opening and closing ensues by means of a hand wrench. The in feed hopper mounted on the granulator upper section pivots with the granulator upper section.

Illustration:
Granulator upper section
(opened)



In addition, an anti-winding device can be also integrated on the granulator upper section. This prevents foil strips, for example, becoming wrapped around the rotor axis and thus causing operational faults.

ORIGINAL INSTRUCTION

PART A: Basic machine

Granulator E 30 Series

5.5 Granulator lower section

The granulator lower section and the drive are mounted onto the base frame. The rotor is arranged on bearings in the granulator lower section. The bearings lie outside the grinding chamber and are sufficiently sealed off against penetrating dirt. The stator knives which are installed in the granulator lower section are easily accessible and simple to install and dismantle. The ground material falls through a screen into the suction trough mounted underneath the rotor and can be sucked off from there.

5.5.1 Rotor and cutting knives

Abbildung:

- (1) Stator knives
- (2) Rotor knives

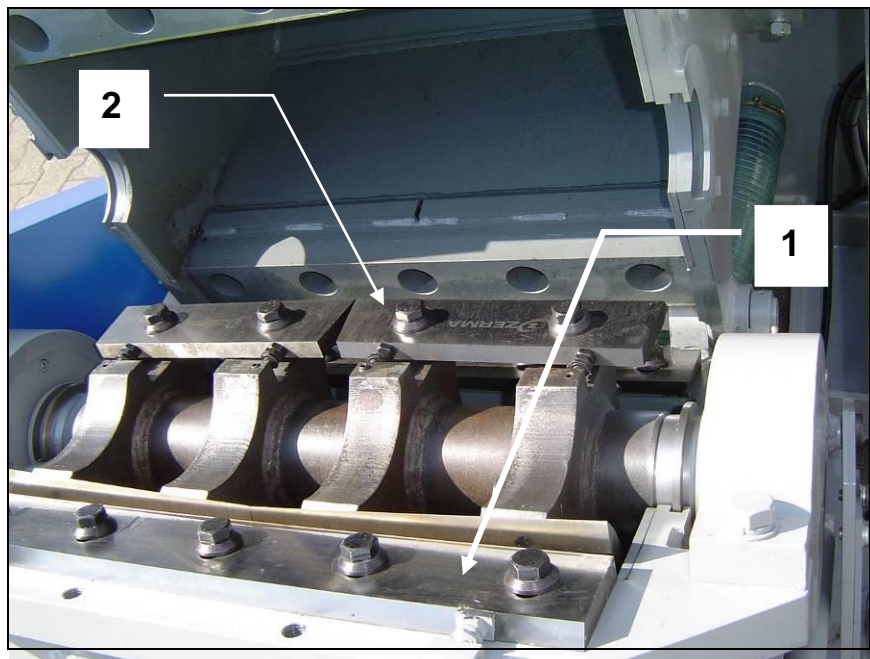

The material is ground between the knives assembled on the rotor and the stator knives which are mounted in a fixed position in the housing.

All rotors are equipped with either a single or a v-shaped scissor cut to decrease the power consumption and to increase the capacity of the machine, while avoiding high amp-peaks.

The design of the rotor has a significant influence on the quality of the grinding process and its results. The rotor construction, the type of knife mounting and the number of knives have all been exactly matched to your task allocation.

ORIGINAL INSTRUCTION

PART A: Basic machine

Granulator E 30 Series

The rotor is arranged on roller bearings, which are situated outside the housing. The "V"-belt pulley is attached by means of a taper bush to the rotor axis. The rotor is dynamically counter balanced and has vibration-free concentricity. The rotor is accessible after opening the granulator upper section.

Illustration:
Bearing



ORIGINAL INSTRUCTION

PART A: Basic machine

Granulator E 30 Series

5.5.2 Screen and screen support

The screen lies in the supporting screen support in the granulator lower section. This screen support is arranged on bearings which can be pivoted and screwed into the working position with the granulator lower section.

Illustration:
Screen and screen
holder

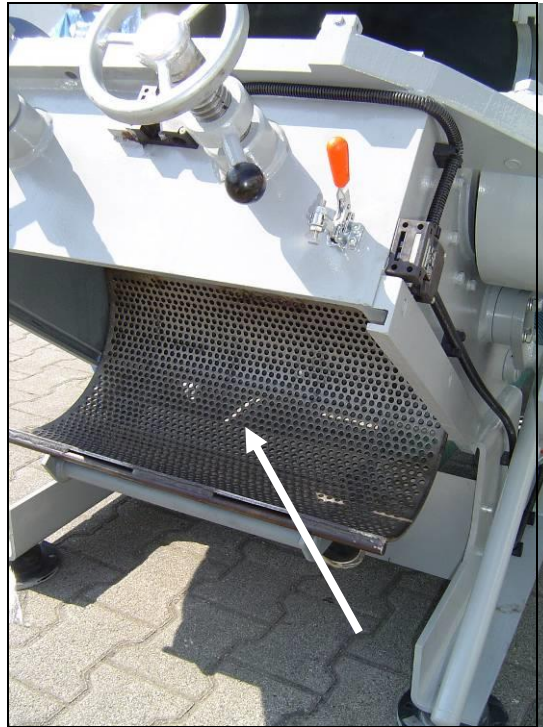

The screen is slightly larger in its radius than the cutting circle of the rotor knife. The screen perforation is selected according to the desired grain size of the grinding material.

All grinding material parts which are smaller than the screen perforation fall through the screen into the suction trough. The screen is replaceable and can be taken out after the suction trough is taken out and the screen holder is lowered.

ORIGINAL INSTRUCTION
PART A: Basic machine
Granulator E 30 Series

5.6 Manual opening devices (only E 30/30, /60 and /100)

Illustration:

- (1) Hand wrench
- (2) Support arm for screen

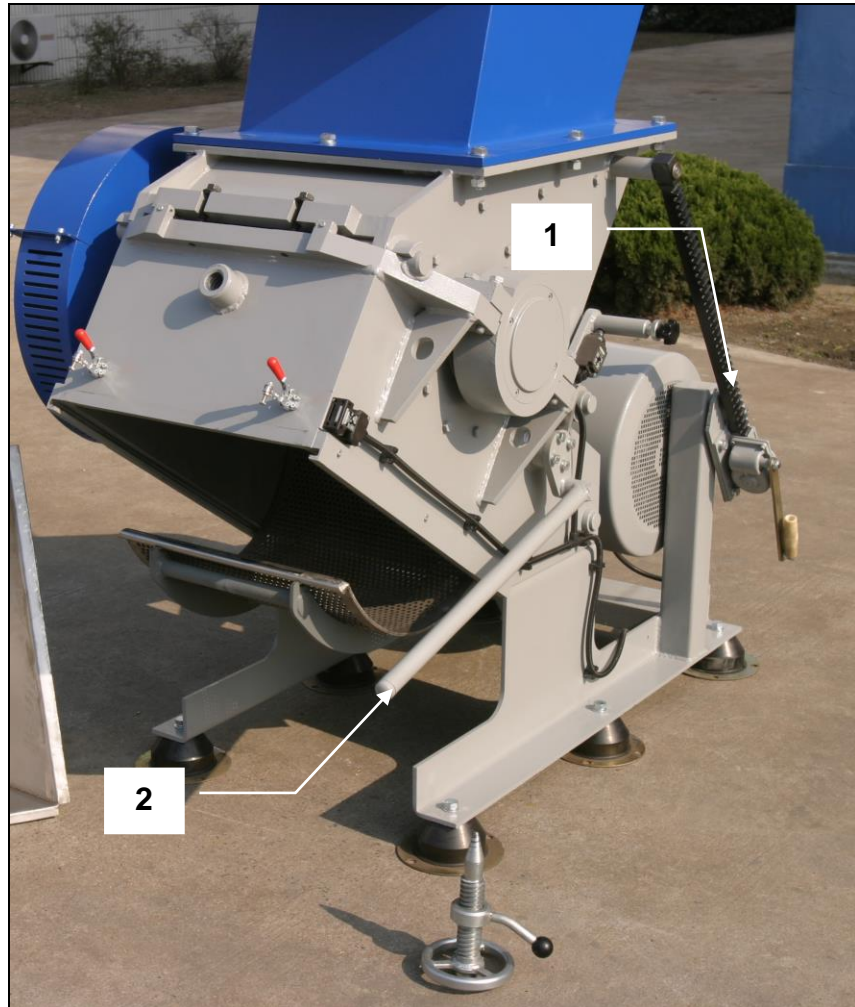

The granulator upper and the screen support section are opened and closed by manually for maintenance work and cleaning. The housing opening is using a hand wrench; the screen is using a support arm to lower the screen.

ORIGINAL INSTRUCTION

PART A: Basic machine

Granulator E 30 Series

5.7 Discharge of grinding material

5.7.1 E 30/30 and 30/60

Illustration:

Blower



The ground material is sucked off by means of a blower out of the suction trough of the granulator. During this process, air is sucked through the in feed hopper of the granulator and drawn through the grinding chamber. At the same time, the grinding chamber and the grinding material are cooled. In addition, a partial air current is sucked in through the by-pass flap which is located on the suction trough. This air current can be regulated with the help of an air regulating flap mounted here.

ORIGINAL INSTRUCTION

PART A: Basic machine

Granulator E 30 Series

5.7.2 E 30/100

Illustration:

Pipe connection for
blower

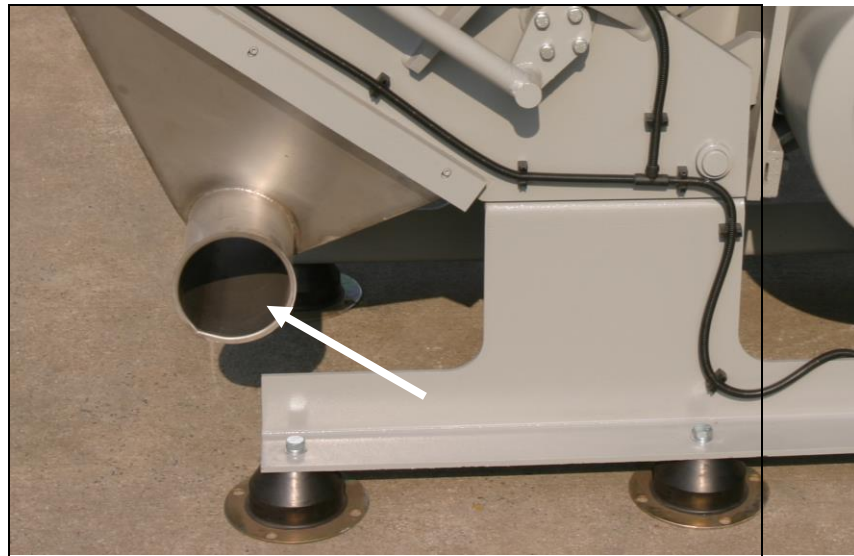



The ground material is sucked off by means of a blower out of the suction trough of the granulator. During this process, air is sucked through the in feed hopper of the granulator and drawn through the grinding chamber. At the same time, the grinding chamber and the grinding material are cooled. In addition, a partial air current is sucked in through the by-pass flap which is located on the suction trough. This air current can be regulated with the help of an air regulating flap mounted here.

If a material blower is installed in your plant configuration, please observe the additional information for work with and on the material blower in *Part B: Accessories*.

ORIGINAL INSTRUCTION
PART A: Basic machine
Granulator E 30 Series

5.8 Housing design

The housing is specially designed for the recycling of light and bulky parts, such as blow moulding rejects or big sprues and rejects in the injection moulding production of TV housing for example. To ensure that these bulky parts are ground properly the machine has an extreme tangential in feed combined with top mounted rotor blades

 DANGER!	
	<p>Those two designing factors on the other hand make the granulator very sensitive in means of mishandling the machine as over feeding or feeding of oversized or high impact strengthen parts that can cause serious damages to the granulator as well as to the operator!</p>

6 INITIAL STARTUP

6.1 General Advice

All work related to start-up may only be carried out by trained specialist personnel.

Check the machine for possible transportation damage or other damage. Should you determine damage, have this confirmed by the freight company and please report this to us in writing immediately after delivery. When starting up for the first time and after setting up ready for service, you must carry out the necessary checks according to the chapter *Machine Check prior to Initial Start-up*.

6.2 Requirements at the application site



The site of application for the machine must exhibit the following features:

- Enclosed space.
- The ground must exhibit sufficient load-bearing capacity (you can find the machine weight in the *Chapter Technical Data*). The unevenness of the ground surface may not exceed 5 mm.
- The machine must be freely accessible from all sides.
- There must be sufficient room available for operating and service personnel.
- Spatial requirements: see *Assembly drawing*. All hinged parts must be able to be opened completely.
- Vibration-free environment.
- The application site must be well-lit.
- The machine may not be exposed to direct radiation caused by radiators or the sun.
- Room temperature: +5° to +40°C
- Relative atmospheric humidity according to DIN 40040:
15 to 70 % (indoor)
By humidity levels higher than 70 %, apply anticorrosive agent to the metallic-finished machine parts. Insulation for the tropics is also necessary.
- The machine may not be operated within range of static discharges or strong magnetic fields as this could lead to faults in the machine control system.



ORIGINAL INSTRUCTION
PART A: Basic machine
Granulator E 30 Series

6.3 Unloading and installing the machine

The machine or the machine components are packed so that they arrive with you safely. To see how the machine is packed or should be packed, please see the *Packing plan*. For unloading the packaged machine or machine components you may use a suitable crane or forklift truck.



 WARNING	
	<p>Suspended load. Falling loads can cause serious injury or death. Only use a crane or a forklift truck which is suitable for the weight and the dimensions of the load.</p>
	<p>Also use a suitable stopping means and pay attention to the gravity centre location. Do not step under the suspended load. Wear a safety helmet in addition to your basic protective gear.</p>

- ↓ After unloading, remove the packaging material and all transportation safety devices.
- ↓ In the case that the granulator and its accessory components have been delivered as individual items, mount these at the site of application using the mounting screws sent with the delivery exactly in accordance with the data given in the *Assembly drawing*. Only in this way can it be guaranteed that there are sufficient delivered piping parts, tubing and cable connections and that the linking places match.

 WARNING	
	<p>Overtipping or falling machine. Serious injury or death can result. In the case that you wish to erect the granulator over a pit, on a frame or on a platform, you must secure the machine by putting mounting screws through the holes on the mounting pads (see <i>Assembly drawing</i>). If assembling the machine on solid ground, this safety device is not absolutely necessary.</p>



- ↓ Align the machine horizontally with the help of a suitable spirit level.
Do not use blocks to place underneath the machine, use instead metal strips in order to prevent buckling of the base frame. Make sure that an even distribution of weight is achieved on all the points of support.

6.4 Electrical connection

 WARNING	
	<p>Dangerous voltage. Touching live parts can lead to serious injury or death. All work which relates to the electricity of the machine may only be carried out by trained electricians. Observe the currently effective EMC regulations.</p>

Voltage, current, frequency and protection are marked on the *Type plate*. The voltage tolerance is $\pm 10\%$.

- ↓ For machines, which have been supplied none pre-wired by VIRTUS the electrical connection, is to be carried out in accordance with the enclosed *Wiring diagram* in the terminal box. When doing this, the regulations of the local electricity authority are to be adhered to. The cable cross section required is to be determined according to the rated capacity of the units.

 WARNING	
	<p>When operating specific equipment caution must be taken to prevent electrical shock. Installation, service, alterations and or modifications must only be done by qualified personal and with up most safety. Not conforming to the requirements could result in bodily injury, death or costly damage.</p>



HINT

Alterations to the wiring diagrams from VIRTUS require our approval. Failure to do this will exclude all guarantee claims.

The wiring schematics are located in the control panel in the event that the control panel is a part of the delivery.

ORIGINAL INSTRUCTION

PART A: Basic machine

Granulator E 30 Series

Connection of Emergency Stop button

The machine may only be operated with installed Emergency Stop buttons. In the case that no Emergency Stop buttons have been installed at the factory, an Emergency Stop button must be installed at the control cabinet, the second at the grinding material in feed.

Checking the rotational direction

Checking the rotational direction is part of the machine checks before initial start-up (see chapter of same name). The steps prior to this check must be carried out beforehand.

- ↓ Switch the machine on and then immediately off again for a short time (see *Switch on machine* and *Switch off machine*).
- ↓ Observe whether the discharge air fan in the drive motor is rotating in the direction of the attached direction arrow.



HINT

If running in the wrong direction, reconnect the motor connection immediately. Damage to the machine will result from operation in the wrong direction.

ORIGINAL INSTRUCTION
PART A: Basic machine
Granulator E 30 Series

6.5 Machine check prior to initial start-up

Check	See chapter
1. When granulator is open, check the knife mounting screws using a torque wrench.	<i>Replacing and checking the cutting knife mountings.</i>
2. Search the grinding chamber for foreign matter.	<i>Cleaning the machine</i>
3. Open the housing flap on the housing lower section and check whether the screen has been inserted in accordance with the regulations.	<i>Emptying the screen</i>
4. Close granulator upper section and fasten screws tightly.	<i>Open and close the granulator.</i>
5. Examine in feed device (accessories) for foreign matter.	<i>Part B: Accessories.</i>
6. Check that the <i>Emergency Stop buttons</i> are unlocked.	
7. Check all safety devices for proper functioning.	<i>Checking the protective devices.</i>
8. Switch on machine for a short time and check rotational direction. The rotational direction can be seen at the discharge air fan of the drive motor (observe running direction arrow).	<i>Electrical connection.</i>
9. Allow machine to run for approx. 10 minutes without grinding material.	<i>Switch on machine.</i>
10. Connect material blower (accessories) and in feed device (accessories), check rotational direction of blower.	<i>Part B: Accessories.</i>
11. Feed grinding material uniformly. Too much grinding material can lead to overload of the machine.	<i>Manual in feed of grinding material.</i>
12. If necessary, check the temperature of the ground material.	
13. Monitor the ammeter. This displays the present current consumption and in this way gives information on the load of the machine. The ammeter is only integrated into granulators which have been delivered with an electrical control system.	
14. Open the air regulating flap on the by-pass flap far enough so that the trough is completely emptied (do not open further!).	<i>Discharge of grinding material</i>

7 OPERATION

Have you read and understood the operation manual, in particular the safety advice in the chapter on?
 You may not operate the machine until you have done so!

TIP



Should faults occur during work with the machine, please observe the advice in the chapter

7.1 Machine checks before switching on the machine

Check	See
1. The knives are properly set and the screws are tightened with the specified torque.	<i>Replacing and checking the cutting knife mountings.</i>
2. The screen is inserted into the screen support in accordance with the rules and the screen support is held fixedly at the end position due to the tightened mounting screws.	<i>Emptying the screen.</i>
3. The grinding chamber is free of foreign matter.	Cleaning the machine
4. The suction trough below the screen support is closed.	<i>Emptying the screen.</i>
5. The granulator upper section is closed and screwed to the granulator lower section.	Error! Reference source not found..
6. All safety devices including those of the installed grinding material in feed and discharge devices are checked and operative.	<i>Checking the protective devices.</i>
7. The material blower is installed properly and the air regulating flap on the suction trough is set so that the grinding material can be completely sucked away.	<i>Part B: Accessories.</i>

7.2 Switch on machine



1. Switch on the grinding material discharge device.
2. Switch on the granulator (main switch to 1). Wait until the rotor has reached its full speed and switched from star to delta.
3. Switch on the grinding material in feed device (accessories).

ORIGINAL INSTRUCTION
PART A: Basic machine
Granulator E 30 Series

7.3 Switch off machine

1. Switch off the grinding material in feed device (accessories).
2. Wait until the remaining grinding material has been ground, and then switch off the granulator, (main switch to 0).
3. Switch off the grinding material discharge device.

7.4 Manual in feed of grinding material

 DANGER	
	<p>Rotating knives. Can cause serious cutting and crushing injuries, possibly leading to death. Do not reach into the in feed hopper or lean in whilst the rotor is running (pay attention to the 3 minute run down time). Only use approved grinding material.</p>

- ↓ Throw the grinding material into the grinding chamber through the splash guard.



If in your design of machine an additional in feed device is installed, please observe the additional information for work with and on the in feed device *Part B: Accessories*.

ORIGINAL INSTRUCTION
PART A: Basic machine
Granulator E 30 Series

8 MAINTENANCE

8.1 Safety advice

Trained specialist personnel may only carry out work included within the framework of maintenance. Carry out the maintenance work within the specified time and document this. The machine will thank you for this by providing high reliability.

 WARNING	
	Danger caused by electrical voltage and starting the machine during maintenance work. Mortal danger.
	Therefore, as a basic rule when carrying out maintenance work: Main switch to 0, safeguard using padlock and attach a warning sign.

8.2 Maintenance plan

The tasks for maintenance work are described in detail in this chapter.

Maintenance work	Every day	Every week	Every month
Check protective devices for proper functioning.		x	
Clean machine.		x	
Check cutting knife mountings.	x		
Check the main bearings and regrease 80g			x
Lubricant replacement, lubricant renewal	See motor manual		
Check "V"-belt tension force and "V"-belt condition.			x
Check condition of cutting knives.		x	
Check all screws of the machine for a tight fit.		x	
Check wearing parts. (screen, wear plates)			x

Yearly maintenance



The purpose of yearly maintenance of the machine is primarily to check the general condition of the machine and to arrange for the supply of any necessary replacement parts in good time. A service engineer from VIRTUS Equipment can also carry this out on request.

8.3 Checking the protective devices

For this, see also the chapter *Protective devices*.

Check the safety devices for:



- Stipulated condition,
- Stipulated location,
- Safe mounting,
- Stipulated function.

 WARNING	
	<p>Danger due to non-functioning protective devices. Serious injury or death can result.</p> <ul style="list-style-type: none">• Eliminate all defects before you put the machine into operation!• If defects occur during operation, stop the machine immediately and eliminate the defects!• Do not change or remove any protective devices. Do not put any protective devices out of action by modifying them.

ORIGINAL INSTRUCTION
PART A: Basic machine
Granulator E 30 Series

8.4 Open and close the granulator (E 30/30, /60 and /100)

For some maintenance work it is necessary to open the granulator.

 WARNING	
	<p>Granulator upper section pivots downwards. Serious injury can result. Always open the granulator upper section completely. Intermediate positions are not allowed. Make sure when closing that no persons are in the danger area.</p>

8.4.1 Opening the granulator upper section

Proceed as follows:

- ↓ Switch off the granulator at the main switch
- ↓ Safeguard main switch using a padlock.
Open the bolts, which are connecting the lower with the upper section of the granulator.

Illustration:

- (1) Hand wrench
- (2) Mechanical time delay (threaded spindle)

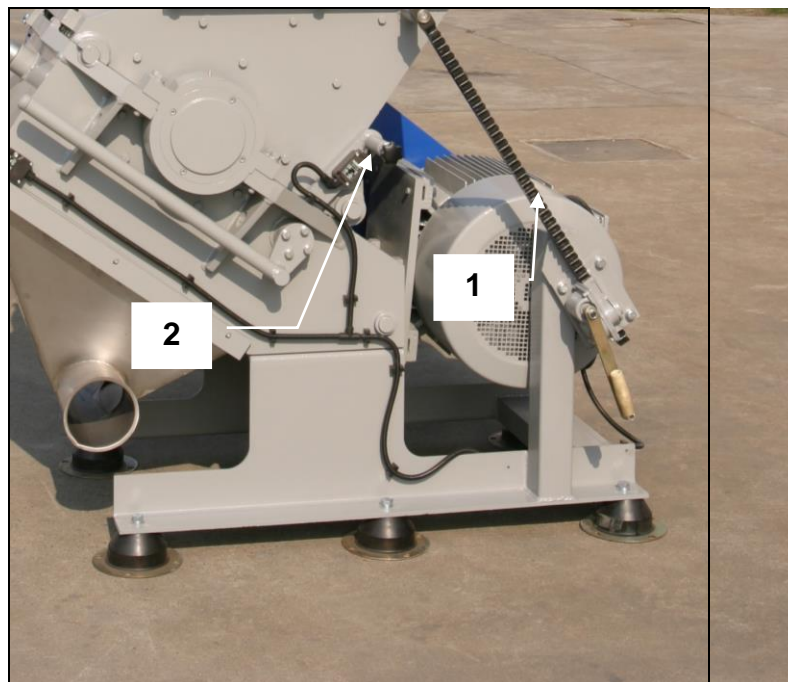

- ↓ Screw out the threaded spindle of the mechanical time delay
- ↓ Open the housing by using the hand wrench

ORIGINAL INSTRUCTION
PART A: Basic machine
Granulator E 30 Series

8.4.2 Closing the granulator

Proceed as follows:

- ↓ Clean all surfaces between the granulator upper section and the granulator lower section with a hand brush as well as all contact surfaces on the screen.
- ↓ Check that there are no objects in the grinding chamber.
- ↓ Close the hopper slowly to ensure that all parts fit properly, by using the hand wrench
- ↓ Tighten the connecting bolts between the granulator lower section and the granulator upper section.
- ↓ Rotate the threaded spindle in completely.
- ↓ Machine can be started again.

ORIGINAL INSTRUCTION

PART A: Basic machine

Granulator E 30 Series

8.5 Replacing the screen (E 30/30, /60 and /100)

In order to keep the throughput of the granulator and the quality of the grinding material constant, the condition of the screen must be checked regularly.

The screen may be damaged, dirty or not suitable for the grinding material:

- Screen holes too fine: overheating of the grinding material.
- Screen holes too course: parts in ground material which are too big.

Proceed as follows:

- ↓ Switch off the granulator at the main switch, safeguard main switch using a padlock.
- ↓ Rotate out the threaded spindle by hand.
- ↓ Open the housing flap.
- ↓ Unfasten the screen support mounting screws.





ORIGINAL INSTRUCTION

PART A: Basic machine

Granulator E 30 Series



- ↓ Pivot the screen support downwards, by hand by using the support arm
- ↓ Remove the screen.
- ↓ Put a new screen into the screen support.
- ↓ Pivot the screen support into the working position and fasten using the mounting screws.
- ↓ Close the housing flap.
- ↓ Rotate the threaded spindle in completely by hand.
- ↓ Granulator can be started again.

8.6 Cleaning the machine

 WARNING	
	<p>Danger of cutting caused by sharp cutting knives, even when the rotor is at a standstill. Serious injury, particularly to hands and fingers, can result. Wear protective gloves.</p>

Proceed as follows:

- ↓ Open granulator (see *Error! Reference source not found.*).
- ↓ Remove the screen.
- ↓ Empty the screen.

 WARNING	
	<p>Inhalation of grinding dust which is dangerous to the health. This can result in injury to the respiratory tract. Never blow out the grinding material residue, use suction instead. Wear breathing protection if necessary.</p>

- ↓ Pre-clean the grinding chamber using a hand brush.
- ↓ Suck up the remaining grinding material residue using a suitable suction device.
- ↓ Remove clinging grinding material residue using a suitable wooden scraper.
- ↓ Put the screen into the screen support.
- ↓ Pivot the screen support into the working position using the hydraulic system and fasten with the mounting screws
- ↓ Close the granulator upper section (see *Closing the granulator*).
- ↓ Rotate in the threaded spindle completely
- ↓ Machine can be started again

8.7 Replacing the main bearings

The main bearings of the machine are dimensioned so that a bearing replacement is only necessary in exceptional cases. Dismounting and mounting of the bearings requires specialist knowledge and a careful working method. Therefore, in addition to the following advice, please observe the instructions given in the installation manual of the bearing manufacturer.

The bearings mounted in this machine are indicated in the spare parts list. A requirement for dismounting and mounting the bearings is a suitable pulling-off device.

8.7.1 Dismounting the main bearings

To dismount the bearings proceed as follows:

The parts which are marked with a piece number are illustrated in the drawings of the spare parts list!

- ↓ Dismount the "V"-belt cover.
- ↓ Dismount the "V"-belts (see *replacing the screen*).
- ↓ Loosen the tensioning element for the "V"-belt pulley (see, *Mounting and dismounting TAPER-LOCK tensioning element*).
- ↓ Pull the "V"-belt pulley off the rotor axis, do not tip up. Use suitable lifting and stopping means.
- ↓ Pull the distance sleeve off the rotor axis.
- ↓ If the granulator is equipped with a disk fly wheel, dismount this in the same way as the "V"-belt pulley.
- ↓ Open the granulator upper section (see *Opening the granulator*).
- ↓ Dismount the cutting knives (see *Dismounting the cutting knives*).
- ↓ Unscrew the bearing housing from the granulator lower section.
- ↓ Carefully lift out the complete rotor using suitable lifting and stopping means.
- ↓ Lay the rotor down in a safe location. Suitable for this are timber beams of appropriate size.
- ↓ Loose the bearings cover mounting screws and take off the bearing cover.
- ↓ Pull the bearing housing off with a pulling-off device.
- ↓ Pull the bearing off the rotor axis using a pulling-off device.

ORIGINAL INSTRUCTION
PART A: Basic machine
Granulator E 30 Series

8.7.2 Mounting the main bearing

To mount the bearings proceed as follows:

- ↓ Before mounting, clean the bearing surfaces and the shaft surfaces thoroughly and grease lightly.
- ↓ Mount bearing in bearing housing.
- ↓ Attach the bearing with the bearing housing to the rotor axis.

HINT



- During mounting, the mounting forces must always engage into the inner ring, otherwise the roller bodies will be damaged.
 - The hardened bearing rings are sensitive to impact stress. For this reason, never hit directly on the rings with the hammer, use instead preferably a brass arbor or better still a striking bush (piping piece) made from a soft material. The inner diameter of the striking bush should be only slightly larger than the diameter of the bearing base.
 - The bearing is then pushed onto the shaft using light blows. When doing this, the force of pressure must be evenly distributed on the circumference of the bearing ring.
- ↓ Lift the rotor using suitable lifting and stopping equipment and put carefully into the receptacle of the granulator lower section.
 - ↓ Attach the bearing housing to the granulator lower section using screws.
 - ↓ Mount the cutting knives.
 - ↓ Close the granulator upper section (see *Closing the granulator*).
 - ↓ If the granulator is equipped with a disk flywheel:
 - ↓ Push the disk flywheel onto the rotor axis and tighten using the tensioning element.
 - ↓ Push the distance sleeve onto the rotor axis.
 - ↓ Mount the "V"-belt pulley and tighten using the tensioning element. (see, *Mounting and dismounting TAPER-LOCK tensioning element*).
 - ↓ Pull on "V"-belts and adjust the "V"-belt tension force (see *Retensioning and relaxing the "V"-belts*).
 - ↓ Attach the "V"-belt cover.
 - ↓ Carry out a test run.

ORIGINAL INSTRUCTION
PART A: Basic machine
Granulator E 30 Series

8.8 Lubricating the main bearings

An important requirement for high operational safety and long service life of the arrangement of bearings is the correct lubricant supply. Every VIRTUS machine is greased and checked in test runs before delivery.

HINT



Unsuitable lubricant, lubricant deficiency, excessive lubrication or impurities in the lubricant lead to overheating and thus extreme wear of the bearings.

8.8.1 Lubrication intervals:

Shift operation	Replace lubricant	Check
One shift operation:	every 18 months	monthly
Two shift operation:	every 9 months	monthly
Three shift operation:	every 6 months	monthly

8.8.2 Check lubricant quality

You can judge whether the lubricant needs to be replaced by checking for the following features:

- change in consistency,
- discolouration,
- degree of soiling.

8.8.3 Replacing or refilling lubricant

HINT



- Fill the bearings uniformly with grease, so that all operating surfaces are well greased.
- For the rotor bearings, a lubricant quantity of one third to a maximum of half of the bearing volume per bearing is required. If too much grease is filled in, the lubricant will become unusable as a result of excessive temperature.
- Only one type of grease may be used, mixing different types of grease is not allowed. The bearings have been filled at the factory with lithium base saponification roller bearing grease F3.
- To find out which lubricants from which manufacturers you can use, look in the *List of lubricants*.

ORIGINAL INSTRUCTION

PART A: Basic machine

Granulator E 30 Series

Refilling lubricant

The grease reaches through the circulating grooves and bores via lubrication nipples into the interior of the bearing.
The greasing quantity is 60 to 100 g roller bearing grease F3 per bearing.

Illustration:
Grease nipple



Replacing lubricant

Only in the case of unusual bearing noises or overheating is it also necessary to renew the lubricant between the specified intervals. Mounting and dismounting of the bearings is to be carried out in accordance with the instructions in this operation manual (see *opening and closing the granulator*).

- ↓ Open the bearing.
- ↓ Remove the bearing casing and the bearing cover.
- ↓ Clean the bearing carefully using petroleum ether.
Petroleum ether, petroleum, spirit, aqueous neutral or alkaline cleaning agents may be used to clean the bearings. After washing out, the bearing must immediately be preserved using lubricant, in order to avoid corrosion.
- ↓ Fill bearing with approved lubricant (see *List of lubricants*).

ORIGINAL INSTRUCTION
PART A: Basic machine
Granulator E 30 Series

8.8.4 List of lubricants

Country of manufacture / manufacturer	Roller bearing grease
ARAL	ARAL Grease HL 3
BP	BP ENERGREASE LS 3
CASTROL	CASTROL SPHEEROL AP 3
ESSO	Beacon 3
FUCHS	FUCHS Grease 1200 FUCHS Grease FWA 220
SHELL	SHELL Alvania Grease 3
MOBIL-OIL	MOBILUX 3
WISURA	WISURA Liba L 3
Zeller & Gmelin	ZET GE Grease M 50
FAG	FAG L 71
ANTAR Petroles de l'Atlantique	ROLEXA
Holland, Beverol	Beverol Multi Purpose Grease
Italy, Agip	AGIP Grease 33 FD
Sweden, NYNÄS	Nynäs FI 3-42

ORIGINAL INSTRUCTION
PART A: Basic machine
Granulator E 30 Series

8.9 Mounting and dismounting TAPER-LOCK tensioning element

The motor-"V"-belt pulley is attached onto the shaft by means of a TAPER-LOCK tensioning element. The disks must be dismantled for certain maintenance work.

IMPORTANT: Follow all instructions in this manual carefully. This is necessary to insure satisfactory performance.

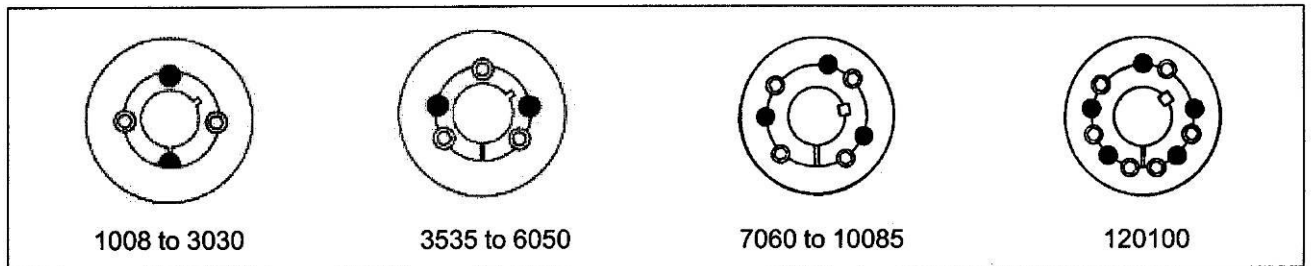

To Install:

1. Clean shaft, bore, and outside of bushing, and bore of hub (taking bushing from hub if already assembled). Remove any oil, lacquer, or dirt. Place bushing in hub and match half holes to make complete holes (each complete hole will be threaded on one side only).
2. Oil thread and point of set screws or thread and under head of cap screws. Place screws loosely in holes that are threaded on hub side (shown thus  in diagram).
3. Make sure bushing is free in hub. Slip assembly onto shaft and locate in position desired.
4. Tighten screws (see note*) alternately and evenly until all are pulled up very tightly. Use a piece of pipe on wrench to increase leverage. (See table for wrench torque on reverse side.)
5. Hammer against large end of bushing using hammer and block or sleeve to avoid damage. Screws can now be turned a little more using the specified wrench torque. Repeat this alternate hammering and screw re-tightening until the specified wrench torque no longer turns the screws after hammering.
6. After drive has been running under load for a short time stop and check tightness of screws. Fill other holes with grease to exclude dirt.

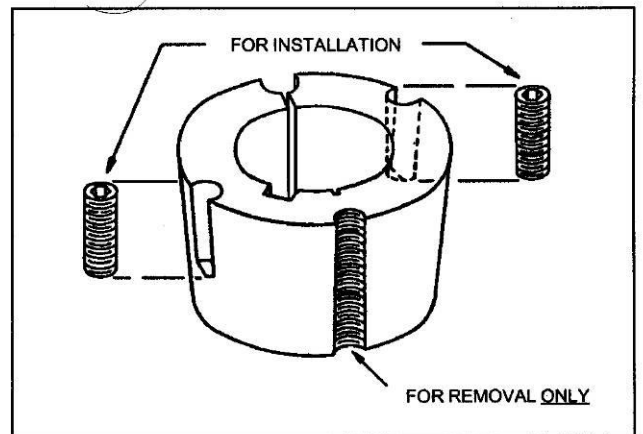

To Remove:

1. Remove all screws. Oil thread and point of set screws or thread and under head of cap screws.
2. Insert screws in holds that are threaded on bushing side (shown thus  in diagram). In sizes where washers are found under screw heads, be sure to use these washers. Note that one screw in each hub is left over and is not used in this loosening operation.
3. Tighten screws alternately until bushing is loosened in hub. If bushing does not loosen immediately, tap on hub.

8.9.1 Table for the tightening torque of the screws

Tensioning element (Type)	Screws-Tightening torque in Nm	Screw details	
		Number	Size (BSW)
2012	31	2	7/16"
3535	60	3	1/2"

ORIGINAL INSTRUCTION

PART A: Basic machine

Granulator E 30 Series

8.9.2 Mounting the TAPER-LOCK tensioning element

Proceed as follows:

- ↓ Remove the protective coating from the bore and outside of bush, and bore of hub. After ensuring that the mating tapered surfaces are completely clean and free from oil or dirt. Insert bush in hub so that holes line up.
- ↓ Sparingly oil thread and point of grub screws, or thread and under head on cap screws. Place screws loosely in holes threaded in hub, shown thus © in.
- ↓ Clean shaft and fit hub to shaft as one unit and locate in position desired, remembering that bush will hip the shaft first and then will be slightly drawn on the bush.
- ↓ Using a hexagon wrench tighten screws gradually and alternately to certain torque.
- ↓ Hammer against large-end of bush, using a block or sleeve to prevent damage. (This will ensure that the bush is seated squarely in the bore). Screws will now turn a little more. Repeat this alternate hammering and screw tightening once or twice to achieve maximum grip on the shaft.
- ↓ If a key is to be fitted place it in the shaft keyway before fitting the bush. It is essential that it is a parallel key and side fitting only and has TOP CLEARANCE.
- ↓ After drive has been running under load for a short time stop and check tightness of screws.
- ↓ Fill empty holes with grease to exclude dirt.

8.9.3 Dismounting the TAPER-LOCK tensioning element

Proceed as follows:

- ↓ Slacken all screws by several turns, remove one or two according to number of jacking off holes shown thus • in the illustration. Insert screws in jacking off holes after oiling thread and point of grub screws or thread and under head of cap screws.
- ↓ Tighten screws alternately until bush is loosened in hub and assembly is free on the shaft.
- ↓ Remove assembly from shaft.

ORIGINAL INSTRUCTION
PART A: Basic machine
Granulator E 30 Series

8.10 Work on the "V"-belts

"V"-belts are wearing parts, which stretch and must be retensioned. In order to guarantee a long service life of the "V"-belts, regular checks on the tension force of the "V"-belts and the condition of the "V"-belts are necessary.

8.10.1 Checking the tension force of the "V"-belt

Illustration:

a: Distance between roller centres
 b: Sag
 F: Force(direction)

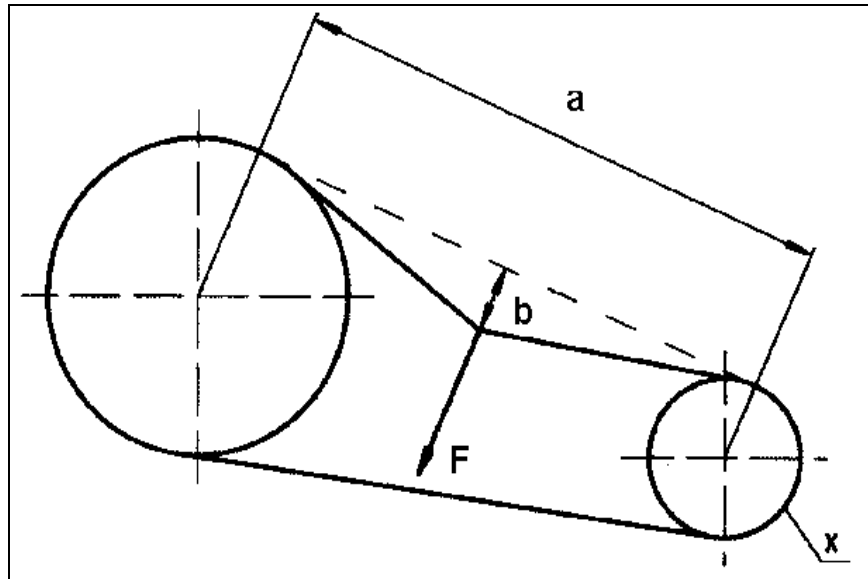

- ↓ Remove the "V"-belt cover.
- ↓ Measure the distance between the roller centres.
- ↓ Determine the belt sag force F for each belt at 16 mm sag if sag "b" is equal to 1 m distance between roller centres. Do this by measuring at the middle of the distance between roller centres at a right angle to the "V"-belt.

		Force required for 1 m distance between roller centres and 16 mm sag	
Profile section	Efficiency of x in mm	P in Newton	P in lbs
SPB	160 - 224	35 - 50	7,7 - 11
SPB	236 - 315	50 - 65	11 - 14,3

- ↓ Compare determined value with the value in the above table. If the value lies below the lowest tolerance limit, the "V"-belt must be retensioned. If the value lies above the highest tolerance limit, the "V"-belt must be relaxed.

ORIGINAL INSTRUCTION

PART A: Basic machine

Granulator E 30 Series



8.10.2 Retensioning and relaxing the "V"-belt

Enlarging or decreasing the centre distance "A" into which the drive motor is shifted carries out tensioning or relaxing the "V" - belt.

Proceed as follows:

- ↓ Loosen the tensioning screw.
- ↓ Shift the drive motor as required onto the sliding rails.
- ↓ Lock the drive motor into new position using both tensioning screws in such a way that the motor shaft is parallel to the rotor axis and aligned.
- ↓ Check the tension force of the "V"-belt (see *Checking the tension force of the "V"-belt*).
- ↓ Mount the "V"-belt cover.

8.10.3 Checking "V"-belt condition, replacing "V"-belt

 CAUTION	
	<p>Danger of pulling into machine caused by running "V"-belts.</p> <p>Hair, jewellery etc. can be pulled into the machine. Serious injury can result.</p> <p>Never dismount the "V"-belt cover and window during operation.</p>

If a "V"-belt is porous or ripped, it must be replaced as follows:

- ↓ Remove the "V"-belt cover.
- ↓ Loosen the front and rear tensioning screw.
- ↓ Relax the "V"-belt by shifting the drive motor.
- ↓ Put new "V"-belt in.
- ↓ Tension the "V"-belt (see *Retensioning and relaxing the "V"-belts*).
- ↓ Mount the "V"-belt cover.

ORIGINAL INSTRUCTION

PART A: Basic machine

Granulator E 30 Series

8.11 Working on the cutting knives

In the case of granulators, the correct grinding properties, correct setting and mounting of the cutting knives are important factors to ensure perfect functioning and economic operation of the machine.

8.11.1 Replacing and checking the cutting knife mountings

Due to their function, certain machine parts are subject to stress in their operating state as a result of vibrations, which can lead to loosening of the screw connections. Therefore, it is absolutely necessary to check the cutting knife mounting screws in accordance with the *Maintenance plan*.

↓ Tighten the mounting screws on the cutting knives using a torque wrench which is set to the required torque for the screw size.

The required torque for the knife fixing bolts is 295 Nm.

You can find out the required torque from the following table. Take note too that the tightening capacity decreases of screws which have been loosened and tightened again several times.



New screws of the same material quality must therefore replace the cutting knife mounting screws after they have been loosened and tightened several times.

Torque:

Bolt type	Grade 8.8		Grade 10.9		Grade 12.9	
	Nm	lbf ft	Nm	lbf ft	Nm	lbf ft
M8	25	18.4	35	25.8	41	30.2
M10	49	36.1	69	50.9	83	61.2
M12	86	63.4	120	88.5	145	106
M16	210	154	295	217	355	261
M20	410	302	580	428	690	508
M24	710	523	1000	737	1200	885

ORIGINAL INSTRUCTION
PART A: Basic machine
Granulator E 30 Series

8.11.2 Checking the condition of the cutting knives

 WARNING	
	<p>Danger of cutting caused by sharp knives, even when the rotor is at a standstill. Serious injury, particularly to hands and fingers, can result. Wear protective gloves.</p>

The cutting knives become blunt after a certain number of operation hours. Therefore they should be checked regularly.

Using blunt knives has the following consequences:

- Decreased grinding capacity.
- Increased current consumption of the drive motor.
- Inexact cut.
- Overheating of the ground material.

ORIGINAL INSTRUCTION
PART A: Basic machine
Granulator E 30 Series

8.11.3 Dismounting the cutting knives

⚠ WARNING	
	Danger of cutting caused by sharp knives, even when the rotor is at a standstill. Serious injury, particularly to hands and fingers, can result. Wear protective gloves.

Proceed as follows:

Illustration:

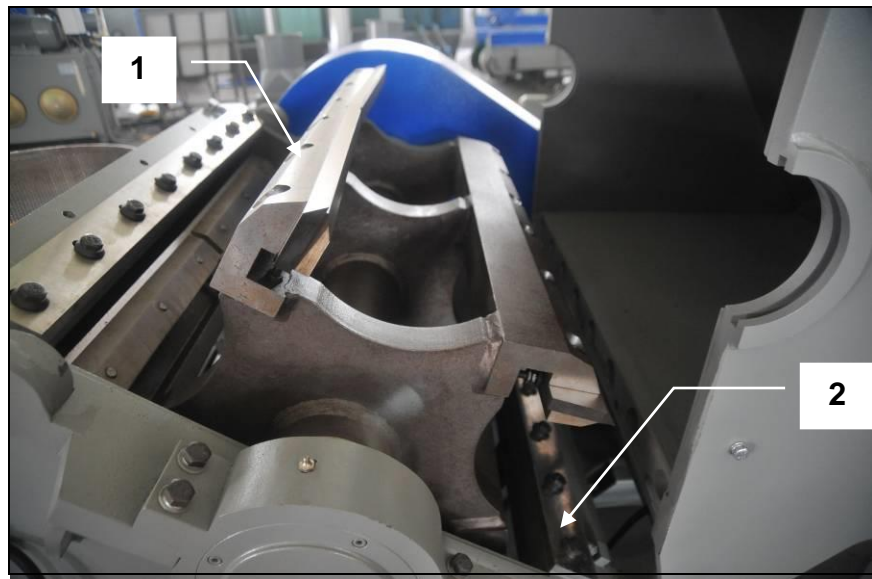

- (1) Rotor knife
- (2) Knife mounting screws



- ↓ Open the granulator (see ***Error! Reference source not found.***).
- ↓ Safeguard the rotor against torsion.
- ↓ Loosen the knife mounting screws.
- ↓ Take out the knife capping and knives.

ORIGINAL INSTRUCTION
PART A: Basic machine
Granulator E 30 Series

8.11.4 Mounting the cutting knives

 WARNING	
	<p>Danger of cutting caused by sharp knives, even when the rotor is at a standstill. Serious injury, particularly to hands and fingers, can result. Wear protective gloves.</p>

HINT



The cutting knives, in particular the rotor knives, should only be sharpened or replaced in sets. There is a danger of balance error if a combination of rotor knives from different knife sets is used.

Proceed as follows:

- ↓ Clean the knife supporting surface and threaded holes.
- ↓ Insert sharp and preset knives and push against the setting surface.
- ↓ Put on the knife capping.
- ↓ Screw in the mounting screws and tighten using a torque wrench.

The required torque for all knife mounting bolts is 580Nm (also see the table under *Replacing and checking the cutting knife mountings*).

- ↓ **Check whether the cutting gap is correct and whether the cutting knives do not collide as the rotor turns.**

TIP



Stator knives from VIRTUS have two symmetrical cutting edges.

This makes it possible to turn the knives and only to sharpen after every second knife change.

- ↓ Remove tools and other objects from the grinding chamber.
- ↓ Close the granulator upper section (see *Closing the granulator*).
- ↓ Switch on the granulator for a short time without grinding material and listen for noises. If you hear unusual noises, determine the cause and eliminate it.

ORIGINAL INSTRUCTION
PART A: Basic machine
Granulator E 30 Series

8.11.5 Sharpening cutting knives



TIP

Specialist sharpening of the cutting knives is part of the service offer of VIRTUS.

 **WARNING**



**Danger of cutting caused by sharp knives, even when the rotor is at a standstill.
Serious injury, particularly to hands and fingers, can result.
Wear protective gloves.**

HINT



The cutting knives, in particular the rotor knives, should only be sharpened or replaced in sets. There is a danger of balance error if a combination of rotor knives from different knife sets is used.

Proceed as follows:

- ↓ Dismount the cutting knives (see *Dismounting the cutting knives*).
- ↓ Sharpen the cutting knives.
A specialist in accordance with the sharpening plan using particular care should uniformly sharpen the cutting knives mechanically. It is important to make sure that sharpening takes place with small grinding allowance and sufficient coolant supply. The sharpening process is finished when the cutting edge is sharply cut. Not all indentations must be ground out; otherwise the number of possibilities for sharpening is unnecessarily reduced. For the sharpening process, use soft grinding wheels (Quality 40 H or 46 K). Knives, which have grinding cracks, are not to be reused due to danger of breakage during operation.
- ↓ Whet the cutting edges of the cutting knives using a whetstone.
By taking these measures, the service life of the cutting knives can be increased.
- ↓ Set the cutting knives (see *mounting the cutting knives*).
- ↓ Mount the cutting knives (see *mounting the cutting knives*).

ORIGINAL INSTRUCTION
PART A: Basic machine
Granulator E 30 Series

Illustration: *Resharpener plan rotor knife*

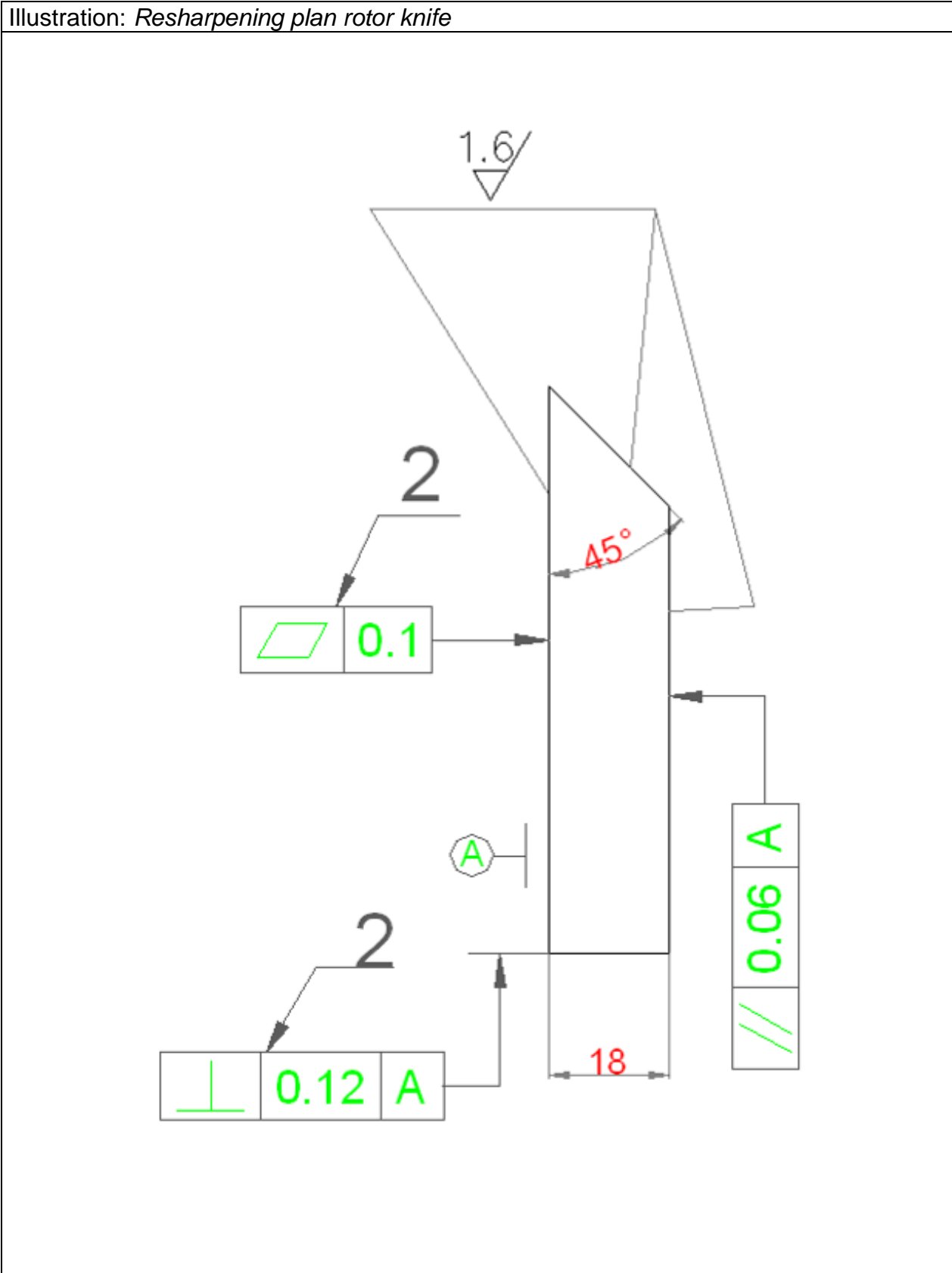

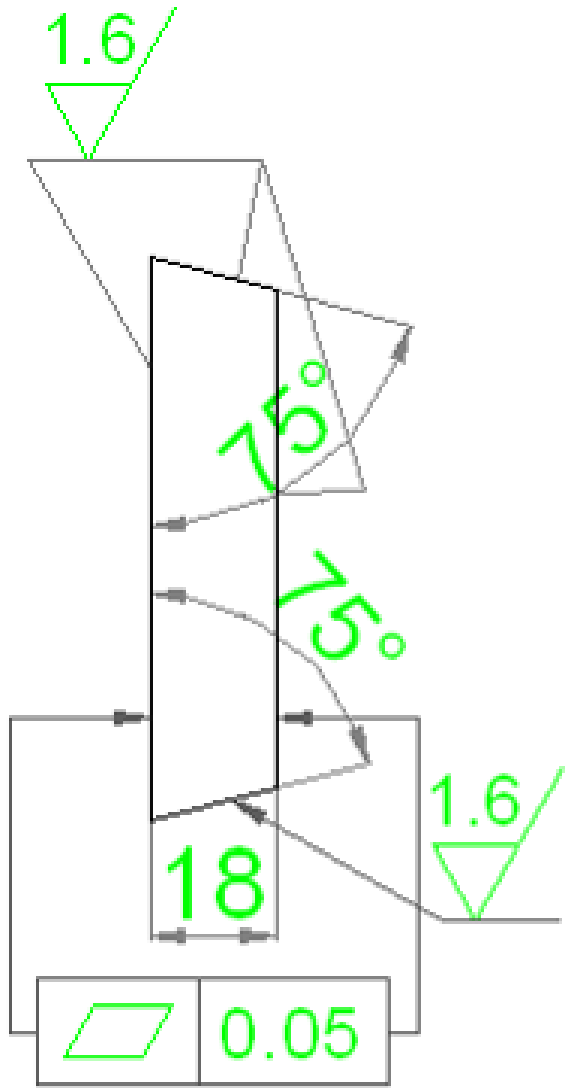

ORIGINAL INSTRUCTION
PART A: Basic machine
Granulator E 30 Series

Illustration: *Resharpener plan stator knife*



ORIGINAL INSTRUCTION
PART A: Basic machine
Granulator E 30 Series

8.11.6 Setting the cutting knives

 WARNING	
	<p>Danger of cutting caused by sharp cutting knives. Serious injury, in particular to hands and fingers, can result. Wear protective gloves.</p>

To simplify knife setting and shorten standstill periods when replacing the knives, a knife setting device is delivered together with rotors with adjustable knives.

Knife setting can be carried out easily outside the machine using this setting device. If you have several knife sets, you will also avoid standstill periods of the machine.

Correct and careful setting of the gap between the rotor knives and the bed knives (cutting gap) is an important requirement for the productive capacity of the granulator.

Factors for the size of the knife gap are the size of the rotor, the design of the rotor and the material to be ground.

The cutting gap is set using the knife gap of the rotor knives in the knife-setting device.

Illustration: *Cutting gap*

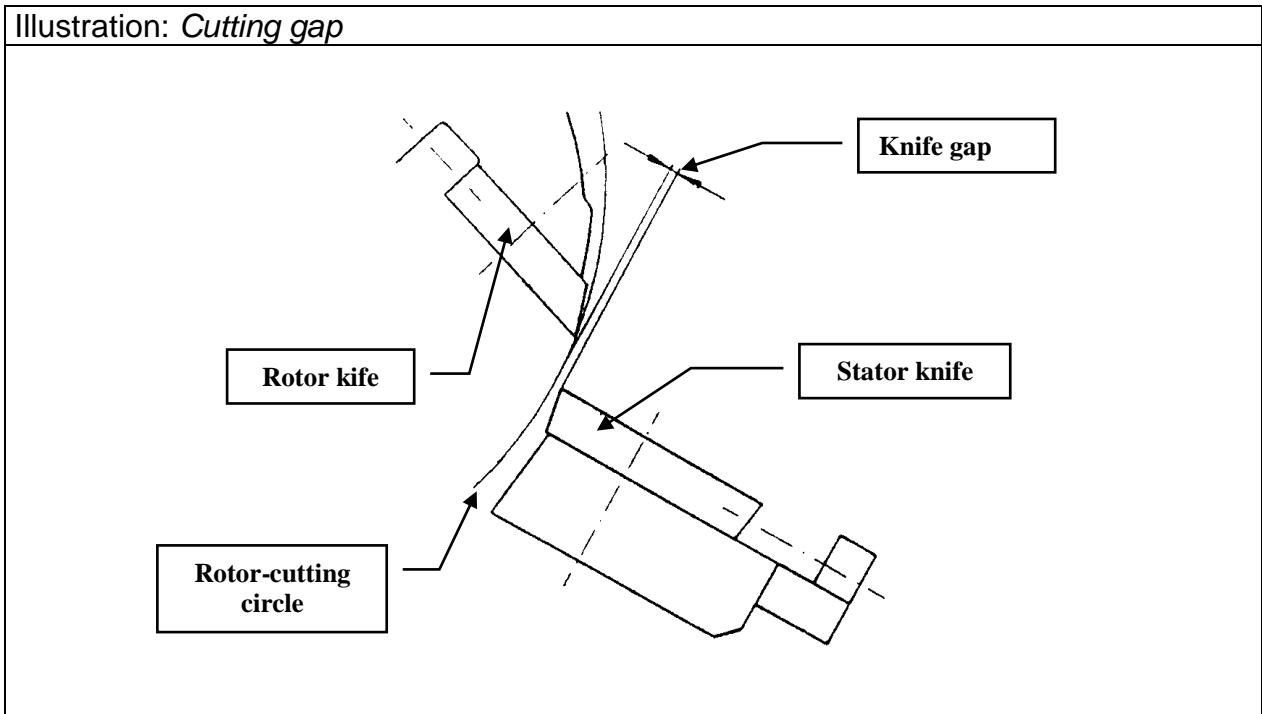

ORIGINAL INSTRUCTION
PART A: Basic machine
Granulator E 30 Series

For setting the rotor knives, proceed as follows:

Illustration:

Knife setting device

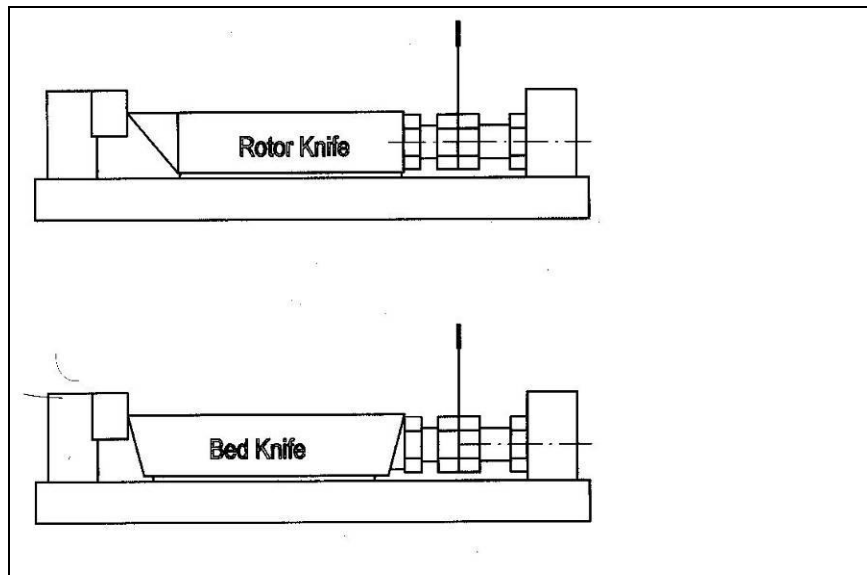
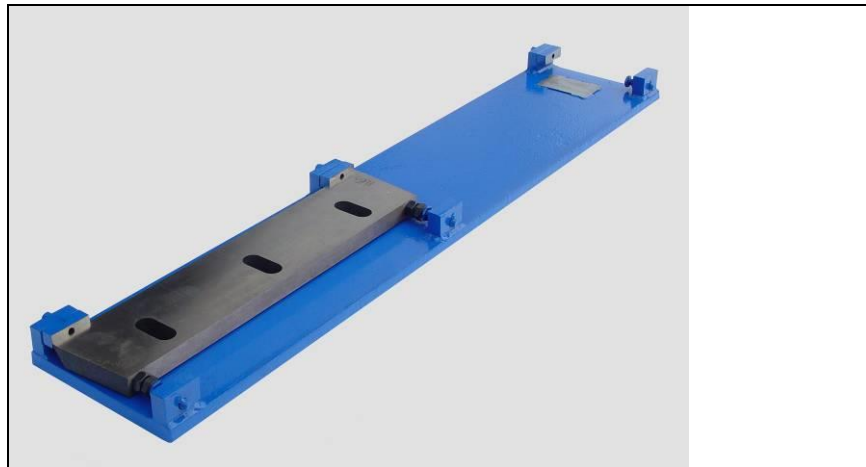

- ↓ Insert the knives into the knife setting device as shown.
- ↓ Select the guide calibre appropriate for the size of the knife gap from the delivered guide calibre set.
The guide calibres are marked with numbers, which when divided by 100, give the thickness in mm.

Further procedure for each setting screw:

- ↓ Push the guide calibre between the stopper of the knife setting device and the setting screw of the cutting knife.
Doing this, the knife edge must lie against the stopper.
- ↓ Unscrew the setting screw of the knife so far that the feeler gage is gently squeezed.
- ↓ Tighten the counter nut.
- ↓ Set all the setting screws as described.
Check the knife gap at the end of setting and correct if required.

ORIGINAL INSTRUCTION
PART A: Basic machine
Granulator E 30 Series

Recommended knife gap: 0,3mm

Illustration:

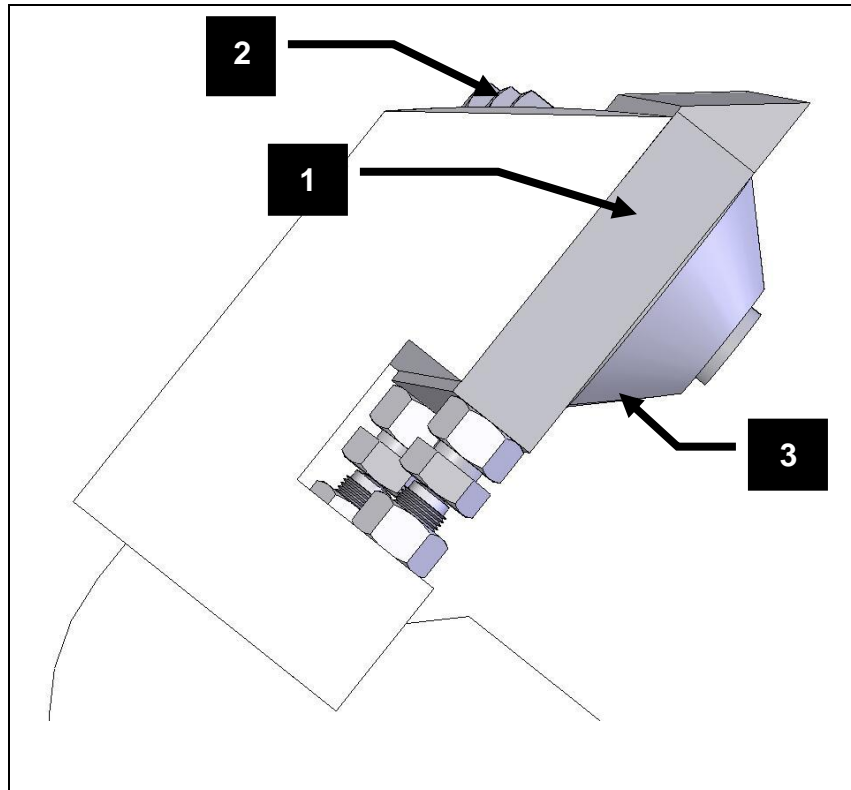

- (1) Rotor knife
- (2) Knife fixing bolt
- (3) Cover discs



HINT

In operating state, the granulator heats up and expands unevenly. Therefore, if the knife gap is too small this can lead to machine damage caused by the knives colliding.

8.11.7 Transporting and storing the cutting knives

 WARNING	
	<p>Danger of cutting caused by sharp cutting knives. Serious injury, in particular to hands and fingers, can result. Only transport and store the cutting knives packaged. Grease the cutting knives well, so that they do not rust. Protect the cutting edges with doubled cardboard and use adhesive tape to safeguard the knives against slipping out of the sides of the sheath.</p> <p>After unpacking, you must degrease the cutting knives so that they can be gripped safely.</p>

ORIGINAL INSTRUCTION
PART A: Basic machine
Granulator E 30 Series

9 TROUBLESHOOTING

9.1 Machine blocks or switches itself off

No.	Possible causes	Remedy required
9.1.1	Too much feed material.	Reduce grinding material in feed.
9.1.2	Screen blocked.	Clean screen, check condition, if necessary select larger screen perforation.
9.1.3	"V"-belts slip.	Check "V"-belt tension and condition and retighten if necessary or replace.
9.1.4	Knife condition.	Check knives and sharpen or replace if needed.
9.1.5	Cutting gap.	Check cutting gap and set according to the instructions in this operation manual.
9.1.6	Suction trough blocked.	Change in rotational direction of blower needed. Replace fan blades if necessary. Open the air regulating flap on the suction trough as far as necessary. Check discharge air flow from cyclone for blockages.
9.1.7	Current failure.	Check limit switch for defective contact. Check electrical connection, if necessary tighten limit switch.
9.1.8	Fuse too small.	Fit larger fuse. Only after consulting the service department of VIRTUS.
9.1.9	Frequent peak loads.	Install disk flywheel.
9.1.10	Rotational direction of rotor.	Check motor and reverse polarity if necessary.
9.1.11	Rotor speed.	Change rotor speed. Only after consulting the service department of VIRTUS.
9.1.12	Bed knives mounted mirror inverted.	Knife tip must protrude in direction of rotation.

9.2 Rotor does not grip bulky material

No.	Possible causes	Remedy required
9.2.1	Knife condition.	Check and sharpen if needed according to the instructions in this operation manual.
9.2.2	Protruding bed knife.	Chamfer bed knives; consult with service department of VIRTUS.

9.3 Overheating of the grinding material

No.	Possible causes	Remedy required
9.3.1	See 9.1.1 to 9.1.5. See 9.1.11 and 9.1.12.	See 9.1.1 to 9.1.5. See 9.1.11 and 9.1.12.
9.3.2	Screen perforation too small.	Insert a screen with larger perforation.
9.3.3	Knives wrongly sharpened.	Modify knife finish. Only after consulting the service department of VIRTUS.
9.3.4	Suction air.	Close air-regulating flap on suction trough step by step.
9.3.5	Material rubs against the housing wall.	Fit anti-winding device.
9.3.6	Insufficient cooling.	Fit water-spraying device, increase air intake (larger suction fan).
9.3.7	Suction fan rotates in wrong direction.	Check connection, if required reverse polarity.

ORIGINAL INSTRUCTION

PART A: Basic machine

Granulator E 30 Series

9.4 Unusual vibrations

No.	Possible causes	Remedy required
9.4.1	Rotor out of balance.	Weigh knives, balance rotor.
9.4.2	Bearing damage.	Check bearings, replace bearings if necessary.
9.4.3	Mounting pads defective (vibration elements).	Check mounting pads and renew these if necessary.

9.5 Extreme cutter wear

No.	Possible causes	Remedy required
9.5.1	Bearing damage.	Check bearings, replace bearings if necessary.
9.5.2	Knife finish.	Check knife and sharpen or replace if necessary.
9.5.3	Wrong cutting angle.	Modify cutting angle after consulting VIRTUSservice department.
9.5.4	Wrong cutting angle.	Check cutting gap and set according to the instructions in this operation manual.
9.5.5	Foreign matter.	Fit feed device with a metal detector.

9.6 Bearings too hot

No.	Possible causes	Remedy required
9.6.1	Too much grease in bearing.	Reduce amount of grease.
9.6.2	"V"-belts too tight.	Reduce tension.
9.6.3	Rubbing on housing sealing ring.	Check sealing ring, oil or replace.
9.6.4	Bearing damage.	Check bearings, replace if necessary.
9.6.5	No grease in bearing.	Lubricate bearing.

9.7 Too many fines in grinding material

No.	Possible causes	Remedy required
9.7.1	Type of material.	Fit fines separator under cyclone.
9.7.2	Screen worn.	Renew screen, possibly using manganese steel.
9.7.3	Unsuitable screen perforation.	Replace screen after consulting VIRTUSservice department.
9.7.4	Suction unit too weak.	Change rotor speed. Only after consulting the service department of VIRTUS.

9.8 Cutting gap alters during operation

No.	Possible causes	Remedy required
9.8.1	Knife mounting screws not tight.	Retighten using torque wrench in accordance with table in operation manual.
9.8.2	Screw fatigue.	Fit new screws.
9.8.3	Cover disks or plate deformed.	Insert new cover disks or plate.
9.8.4	Supporting surfaces not clean.	Clean and de-rust supporting surfaces.
9.8.5	Threads in housing worn.	Fit new bushes in housing.

ORIGINAL INSTRUCTION
PART A: Basic machine
Granulator E 30 Series

9.9 Screen damage

No.	Possible causes	Remedy required
9.9.1	Screen inserted wrongly.	Fit screen correctly.
9.9.2	Screen support buckled.	Replace screen support.

9.10 Granulator does not start

No.	Possible causes	Remedy required
9.10.1	Limit switches not activated.	Check position of limit switch and correct.
9.10.2	Main and control fuses.	Replace fuse.
9.10.3	Feed device not connected.	Switch on in sequence.
9.10.4	Residue material in granulator.	Empty granulator before switching on.
9.10.5	Star delta connection.	Correct wiring on motor.
9.10.6	Motor protection switches off.	Check motor relay for correct setting and increase if necessary.
9.10.7	Star delta time relay.	Correct time.

9.11 Granulator blocks when under load

No.	Possible causes	Remedy required
9.11.1	Feed starts too early.	Start feed only after switch over from star to delta.
9.11.2	Limit switch loose or wrongly set.	Reposition and tighten limit switch.
9.11.3	Fuse defective.	Replace fuse. Fit larger fuse. Only after consulting the service department of VIRTUS GmbH.
9.11.4	Motor fuse switches off - red indicator.	Reduce feed quantity of the grinding material, correct setting, replace fuse.

9.12 Frequent switching off of grinding material in feed device

No.	Possible causes	Remedy required
9.12.1	Current relay switches off.	Correct setting.

10 STORAGE, DISPOSAL, TRANSPORTATION

10.1 Storage





Clean the machine (see *Replacing the screen*). Preserve all polished metal surfaces using a suitable rust preventing agent. Store the machine in an enclosed, dry place. Cover the machine completely with a plastic sheet.

10.2 Disposal



Protect the environment.
 The disposal of machines, machine components and process materials is partially subject to legal controls. More detailed information is given at the relevant administrative authority (e.g. regional and national Water Conservation Bureaux and Environmental Protection Agencies). Only deposit the material to be disposed of at authorized drop-off points.

10.3 Transportation

 WARNING	
	<p>Suspended load. Falling loads can cause serious injury or death. Only use a crane or forklift truck, which is suitable for the weight and dimensions of the loads.</p>
	<p>Also use suitable stopping means and pay attention to the gravity centre location. Do not step under the suspended load. Wear a protective helmet in addition to your basic protective gear.</p>

11 HYDRAULIC MAINTENANCE

Before start-up of the machine, hydraulic oil has to be filled into the tank.

The type of oil which should be used depends on your location. We recommend oil of the type DIN 51524 HLP 32 for areas with temperatures below 0°C in the winter and HLP 46 for temperatures of around 30°C in the summer. For extremely hot tropical areas e. g. Thailand, Malaysia, Nigeria etc. we recommend to use HLP 68.

The first oil replacement should be done after one year and than every year one time. The oil filter has to be replaced too.



HINT

If the oil will not be replaced after this time damage to the hydraulic system can occur, due to overheating of the oil and dirt in the oil. This can lead to a complete standstill of the machine.

When adding hydraulic oil, attention must be paid that the same type of oil is used. If the same type of oil is not available, or if the type used is unknown, the oil in the tank and in the complete hydraulic system has to be removed and the complete system flushed carefully. The system may only be filled with new oil after this has been done. This is necessary to prevent gumming of the valves.

ORIGINAL INSTRUCTION
PART A: Basic machine
Granulator E 30 Series

Hydraulic liquid recommendation:

Designation to DIN 51 524	HLP 32
Ambient temperature:	-7 to +70°C
Supplier	Name of the oil
ARAL	Aral Vitam GF 32 Aral Vitam HF 32
BP	BP Energol HLP-D 32 BP Energol HLP 32 BP Energol SHF 32
ELF	Elfolna 32 Hydrelf 32
ESSO	Nuto H 32 HLPD-Oel 32
FINA	Fina Hydran 32
FUCHS	Renolin MR 10 Renolin B 10
MOBIL	Mobil DTE 24 Mobil DTE 17 Drucköl HLP 32 - C Hydrauliköl HLPD 32
TEXACO	Rando Oil HD A - 32 Rando Oil HD AZ - 32 Alcor Oil DD 32

12 CUSTOMER SERVICE AND SPARE PARTS ORDERS



Should problems occur during operation of the machine or if you have general questions about the machine which this operation manual cannot answer, please do not hesitate to contact us. We would be pleased to help you further in order to solve your problem as quickly as possible.

You can identify the spare parts you require using the spare parts list. Please quote the following information when making your order so that we can deliver the spare parts to you quickly:

- Company name and address.
- Contact person.
- Machine type.
- Machine number.
- Piece number of the spare part.
- Spare part reference.
- Subject number.
- Order quantity.

VIRTUS

311 Era Drive
Northbrook, IL 60062

Tel: 1-847-291-1800

E-Mail: Sales@VIRTUS-Equipment.com
Internet: <http://www.VIRTUS-Equipment.com>



TIP

The easiest way to order your spare parts is to copy the spare parts list and to fill in the order amount after the respective spare part.

ORIGINAL INSTRUCTION
PART A: Basic machine
Granulator E 30 Series

13 SPARE PARTS LIST

13.1 E 30/30

Pos.	Pc	Description/Standard	Partnumber/SAP	Order
100		Machine complete		
101	1	Standard hopper	23007000	
102	1	PVC-curtain 1	80013070	
103	1	Cover plate	20766400	
104	1	PVC-curtain 2	80013070	
105	1	Cover plate	20766400	
106	1	PP-curtain	20766300	
107	1	Shaft for PP-curtain	23000000	
108	1	Housing upper section	23000000	
109	2	Wearing plate upper section	23053300	
110	1	Housing lower section	23000300	
111	2	Wearing plate lower section	23053400	
112	1	Threaded spindle		
113	1	Base frame	23035000	
114	1	Suction trough	23001600	
115	4	Anti vibration pad	80012750	
116	1	Hand winch	80004010	
117	1	Blower 0.75 kW		
200		Screen complete		
201	1	Screen support	23000800	
202	2	Screen support spindle	23054200	
203	1	Screen adjusting bolt	80050594	
204	1	Screen Ø 10	23002800	
205	1	Closing lever	23054500	
300	2	Bearing complete		
301	2	Bearing housing SN216	23054900	
302	2	Bearing 22216/W33	80040271	
303	3	Bearing Cover A	23054700	
304	1	Bearing Cover B	23054800	
305	3	Sealing 95x120x12	80040229	
306	16	Bolt DIN912 M8x20		
400		Drive		
401	1	Motor 7.5 kW	80000290	
		Motor 11 kW	80000270	
402	1	Rotor pulley SPB 335-3	80002140	
403	1	Rotor pulley taper bush TB 3020-70	80002400	
404	5	V-Belt SPB 2000	80040124	
405	1	Motor pulley SPB 118-3	80002110	

ORIGINAL INSTRUCTION

PART A: Basic machine

Granulator E 30 Series

406	1	Motor pulley taper bush 1610-38	80002530	
		Motor pulley taper bush 1610-42	80002540	
407	1	Mounting disc for rotor lock		
408	1	Pulley cover	23052000	
409	1	Lock disc for rotor lock		
410	2	Rotor/Housing sealing		
411	1	Bush		
412	1	Bolt DIN933 M16x50		
413	1	Spring Washer		
414	1	Washer		
415	1	Bolt DIN7991 - M16x40 – 8.8		
416	1	Washer for bearing		
417	1	Motor base frame		
418	6	Bolt DIN933M10x120 8.8	80040673	
419	6	Spring washer DIN127-B 10	80010850	
420	6	Washer DIN125-A 10.5	80010730	
500		S-3 Rotor	23001100	
501	3	Rotor knife C R1	80001000	
502	6	Fixing Bolt M16x45/DIN 912/10.9	80009950	
503	6	Washer Ø36x17x8	80012930	
504	6	Adjusting bolt M10x40/flat head/10.9	20781000	
505	6	Nut M10/DIN 934/10.9	80010450	
506	6	Adjusting bolt M10x30/ball head/10.9	20267900	
507	6	Rotor knife cover plate	80051479	
508	6	Pin ISO8752 – 5 x 30	80010540	
600	2	Stator knife complete		
601	2	Stator knife C S8	80001200	
602	6	Fixing Bolt M16x60/DIN 912/12.9	80010010	
603	6	Step washer Ø36x17x8	80012930	
604	4	Adjusting bolt M10x30/flat head/10.9	20782000	
605	4	Nut M10/DIN 934/10.9	80010450	
606	4	Wedge Washer	80050640	
607	4	Adjusting bolt M10x30/ball head/10.9	20267900	
900		Electrical parts		
901	1	Safety switch		
902	1	Safety switch		
903	1	Control panel	10002061	

ORIGINAL INSTRUCTION
PART A: Basic machine
Granulator E 30 Series

13.2 E 30/60

Pos.	Pc	Description/Standard	Partnumber/SAP	Order
100		Machine complete		
101	1	Standard hopper	22050000	
102	1	PVC-curtain 1	80013070	
103	1	Cover plate	20808600	
104	1	PVC-curtain 2	80013070	
105	1	Cover plate	20808600	
106	1	PP-curtain	80012220	
107	1	Shaft for PP-curtain	20808500	
108	1	Housing upper section	23050000	
109	2	Wearing plate upper section	23053300	
110	1	Housing lower section	23050300	
111	2	Wearing plate lower section	23053400	
112	1	Threaded spindle		
113	1	Base frame	23053900	
114	1	Suction trough	23051600	
115	4	Anti vibration pad	80012750	
116	1	Hand winch	80004010	
117	1	Blower 1.5 kW		
200		Screen complete		
201	1	Screen support	23050800	
202	2	Screen support spindle	23054200	
203	1	Screen adjusting bolt	80050594	
204	1	Screen Ø 10	23052700	
205	1	Closing lever	23054500	
300	2	Bearing complete		
301	2	Bearing housing SN216	23054900	
302	2	Bearing 22216/W33	80040271	
303	3	Bearing Cover A	23055000	
304	1	Bearing Cover B	23055100	
305	3	Sealing 95x120x12	80040229	
306	16	Bolt DIN912 M8x20		
400		Drive		
401	1	Motor 11 kW	80000270	
		Motor 15 kW	80000240	
		Motor 18.5 kW	80000220	
402	1	Rotor pulley SPB 335-3	80002140	
403	1	Rotor pulley taper bush TB 3020-70	80002400	
404	3	V-Belt SPB 2000	80040124	
		V-Belt SPB 2065	80040251	
405	1	Motor pulley SPB 118-3	80002110	

ORIGINAL INSTRUCTION

PART A: Basic machine

Granulator E 30 Series

		Motor pulley SPB 125-3	80002170	
406	1	Motor pulley taper bush 1610-42	80002540	
		Motor pulley taper bush 1610-48	80002500	
407	1	Mounting disc for rotor lock		
408	1	Pulley cover	23052000	
409	1	Lock disc for rotor lock		
410	2	Rotor/Housing sealing		
411	1	Bush		
412	1	Bolt DIN933 M16x50		
413	1	Spring Washer		
414	1	Washer		
415	1	Bolt DIN7991 - M16x40 – 8.8		
416	1	Washer for bearing		
417	1	Motor base frame		
418	6	Bolt DIN933M10x120 8.8	80040673	
419	6	Spring washer DIN127-B 10	80010850	
420	6	Washer DIN125-A 10.5	80010730	
500		S-3 Rotor	23051100	
501	6	Rotor knife C R1	80001000	
502	12	Fixing Bolt M16x45/DIN 912/10.9	80009950	
503	12	Washer Ø36x17x8	80012930	
504	12	Adjusting bolt M10x40/flat head/10.9	20781000	
505	12	Nut M10/DIN 934/10.9	80010450	
506	12	Adjusting bolt M10x30/ball head/10.9	20267900	
507	12	Rotor knife cover plate	80051479	
508	12	Pin ISO8752 – 5 x 30	80010540	
600	2	Stator knife complete		
601	2	Stator knife C S9	80001170	
602	10	Fixing Bolt M16x60/DIN 912/12.9	80010010	
603	10	Step washer Ø36x17x8	80012930	
604	4	Adjusting bolt M10x30/flat head/10.9	20782000	
605	4	Nut M10/DIN 934/10.9	80010450	
606	4	Wedge Washer	80050640	
607	4	Adjusting bolt M10x30/ball head/10.9	20267900	
900		Electrical parts		
901	1	Safety switch		
902	1	Safety switch		
903	1	Control panel	10002071	

ORIGINAL INSTRUCTION
PART A: Basic machine
Granulator E 30 Series

13.3 E 30/100

Pos.	Pc	Description/Standard	Partnumber/SAP	Order
100		Machine complete		
101	1	Standard hopper	22100000	
102	1	PVC-curtain 1	20808900	
103	1	Cover plate	20862100	
104	1	PVC-curtain 2	20808900	
105	1	Cover plate	20862100	
106	1	PP-curtain	20862200	
107	1	Shaft for PP-curtain	20862000	
108	1	Housing upper section	23100000	
109	2	Wearing plate upper section	23053300	
110	1	Housing lower section	23100300	
111	2	Wearing plate lower section	23053400	
112	1	Threaded spindle		
113	1	Base frame	23135000	
114	1	Suction trough	23101600	
115	4	Anti vibration pad	80012750	
116	1	Hand winch	80004010	
200		Screen complete		
201	1	Screen support	23100800	
202	2	Screen support spindle	23054200	
203	1	Screen adjusting bolt	80050594	
204	1	Screen Ø 8	23102700	
205	1	Closing lever	23054500	
300	2	Bearing complete		
301	2	Bearing housing SN216	23054900	
302	2	Bearing 22216/W33	80040271	
303	3	Bearing Cover A??	23055000	
304	1	Bearing Cover B??	23054800	
305	3	Sealing 95x120x12	80040229	
306	16	Bolt DIN912 M8x20		
400		Drive		
401	1	Motor 18.5 kW 400V/50Hz	80000220	
		Motor 18.5 kW 200V/50Hz	80000230	
		Motor 22.0 kW 400v50Hz	80000190	
		Motor 22.0 kW 200v50Hz	80020188	
402	1	Rotor pulley SPB 335-4	80002080	
403	1	Rotor pulley taper bush TB 3535-70	80002320	
404	4	V-Belt SPB 2065	80040251	
405	1	Motor pulley SPB 125-4	80002070	
406	1	Motor pulley taper bush 2012-48	80002500	

ORIGINAL INSTRUCTION

PART A: Basic machine

Granulator E 30 Series

407	1	Mounting disc for rotor lock		
408	1	Pulley cover	23052000	
409	1	Lock disc for rotor lock		
410	2	Rotor/Housing sealing		
411	1	Bush		
412	1	Bolt DIN933 M16x50		
413	1	Spring Washer		
414	1	Washer		
415	1	Bolt DIN7991 - M16x40 – 8.8		
416	1	Washer for bearing		
417	1	Motor base frame		
418	6	Bolt DIN933M10x120 8.8	80040673	
419	6	Spring washer DIN127-B 10	80010850	
420	6	Washer DIN125-A 10.5	80010730	
500	1	S-3 Rotor	23101100	
501	6	Rotor knife C R3	80000980	
502	18	Fixing Bolt M16x45/DIN 912/10.9	80009950	
503	18	Washer Ø36x17x8	80012930	
504	12	Adjusting bolt M10x40/flat head/10.9	20781000	
505	12	Nut M10/DIN 934/10.9	80010450	
506	12	Adjusting bolt M10x30/ball head/10.9	20267900	
507	18	Rotor knife cover plate	80051479	
508	18	Pin ISO8752 – 5 x 30	80010540	
600	2	Stator knife complete		
601	2	Stator knife C S12	80001140	
602	16	Fixing Bolt M16x60/DIN 912/12.9	80010010	
603	16	Step washer Ø36x17x8	80012930	
604	4	Adjusting bolt M10x30/flat head/10.9	20782000	
605	4	Nut M10/DIN 934/10.9	80010450	
606	4	Wedge Washer	80050640	
607	4	Adjusting bolt M10x30/ball head/10.9	20267900	
900		Electrical parts		
901	1	Safety switch		
902	1	Safety switch		
903	1	Control panel	10002080	

ORIGINAL INSTRUCTION
PART A: Basic machine
Granulator E 30 Series

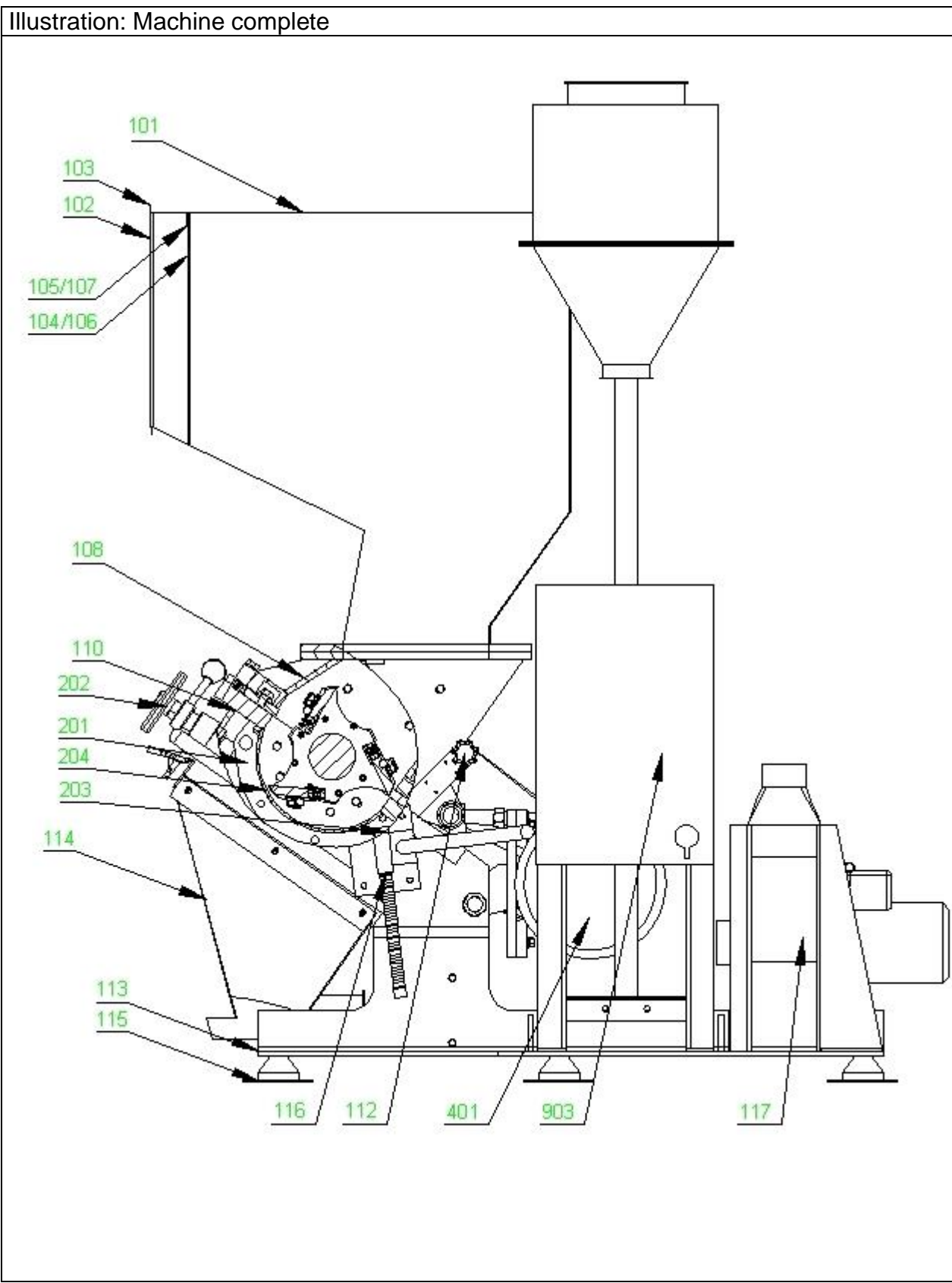

ORIGINAL INSTRUCTION
PART A: Basic machine
Granulator E 30 Series

Illustration: Rotor drive end

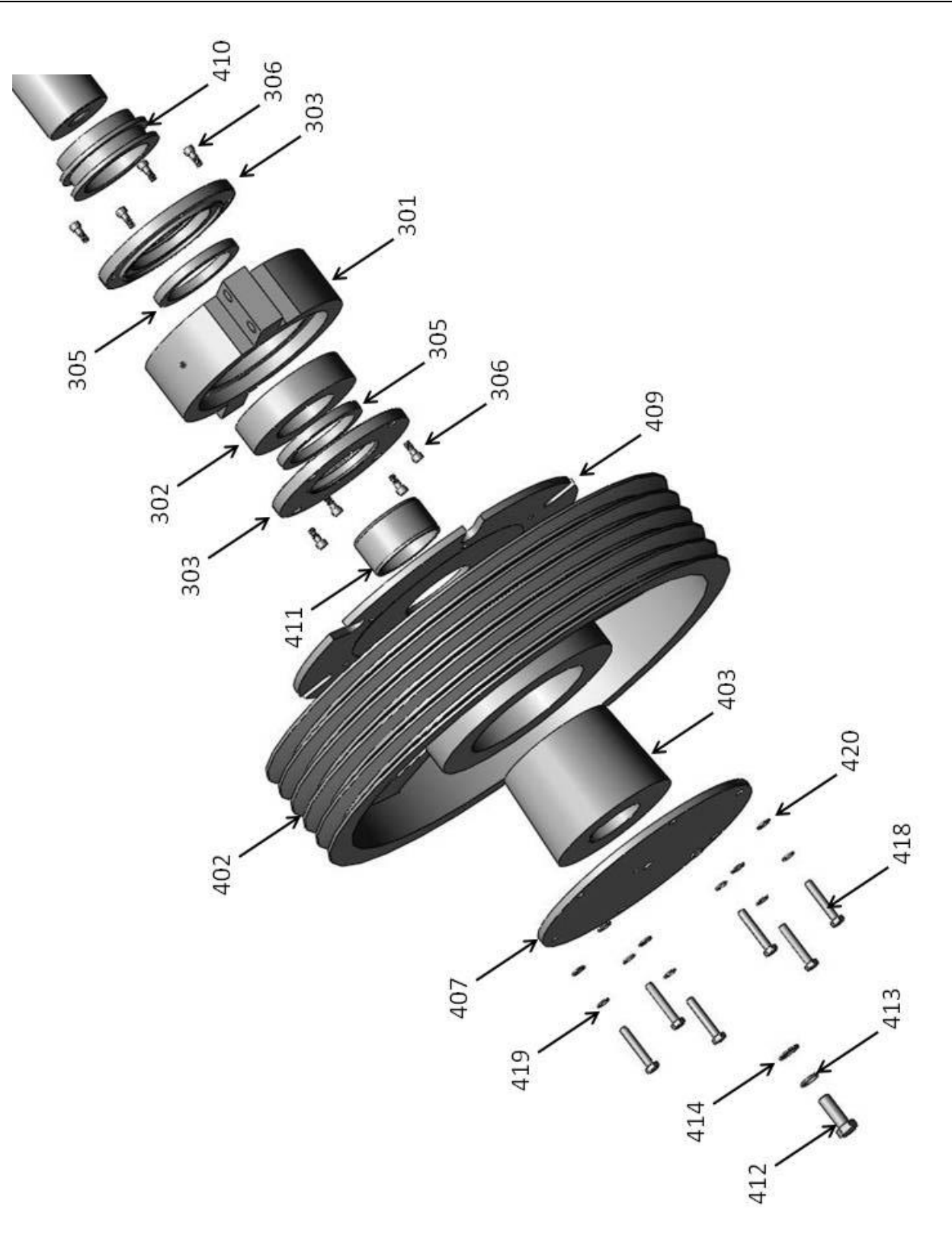

ORIGINAL INSTRUCTION
PART A: Basic machine
Granulator E 30 Series

Illustration: Rotor bearing end

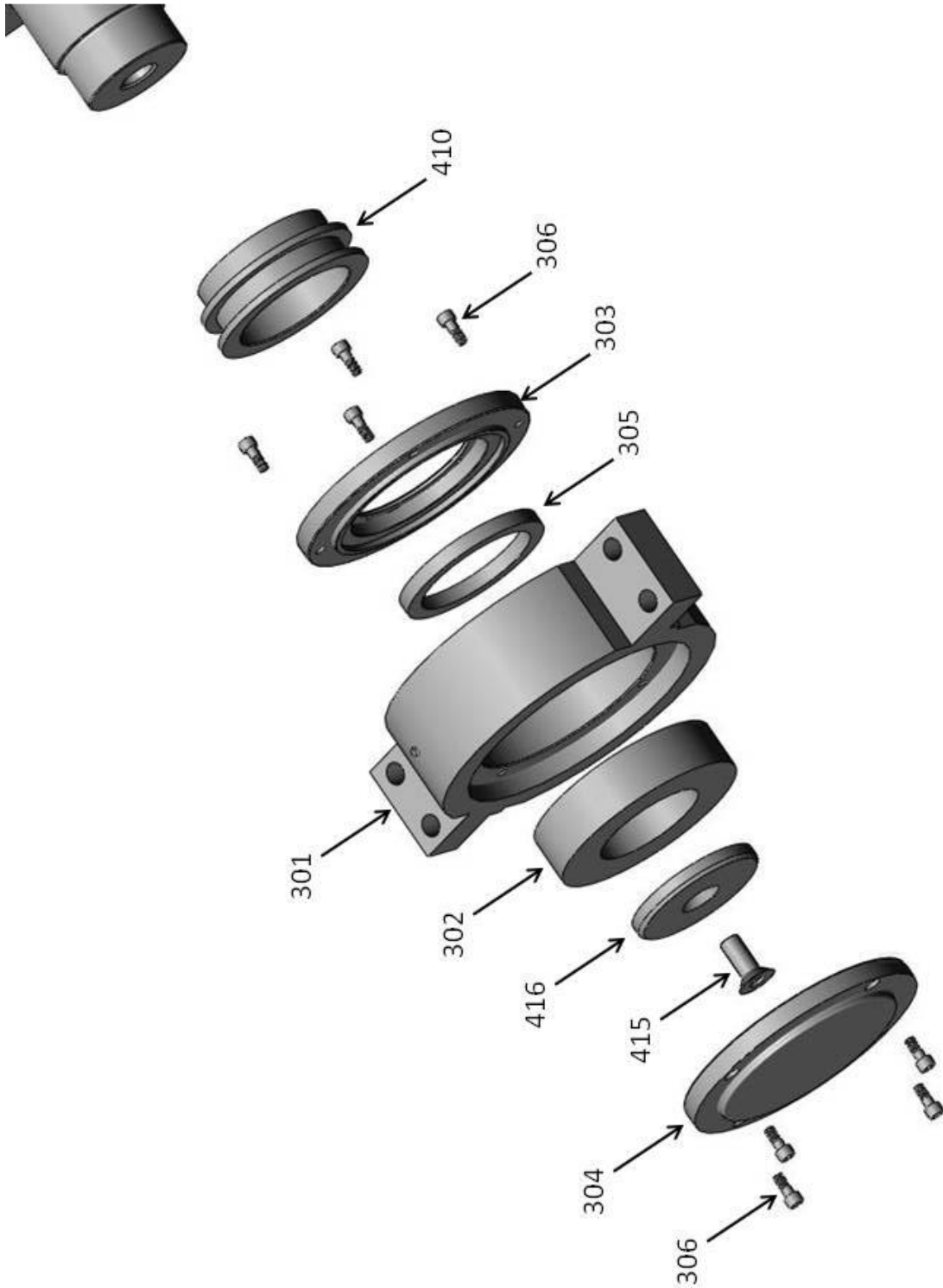

ORIGINAL INSTRUCTION
PART A: Basic machine
Granulator E 30 Series

Illustration: Rotor knife fixing

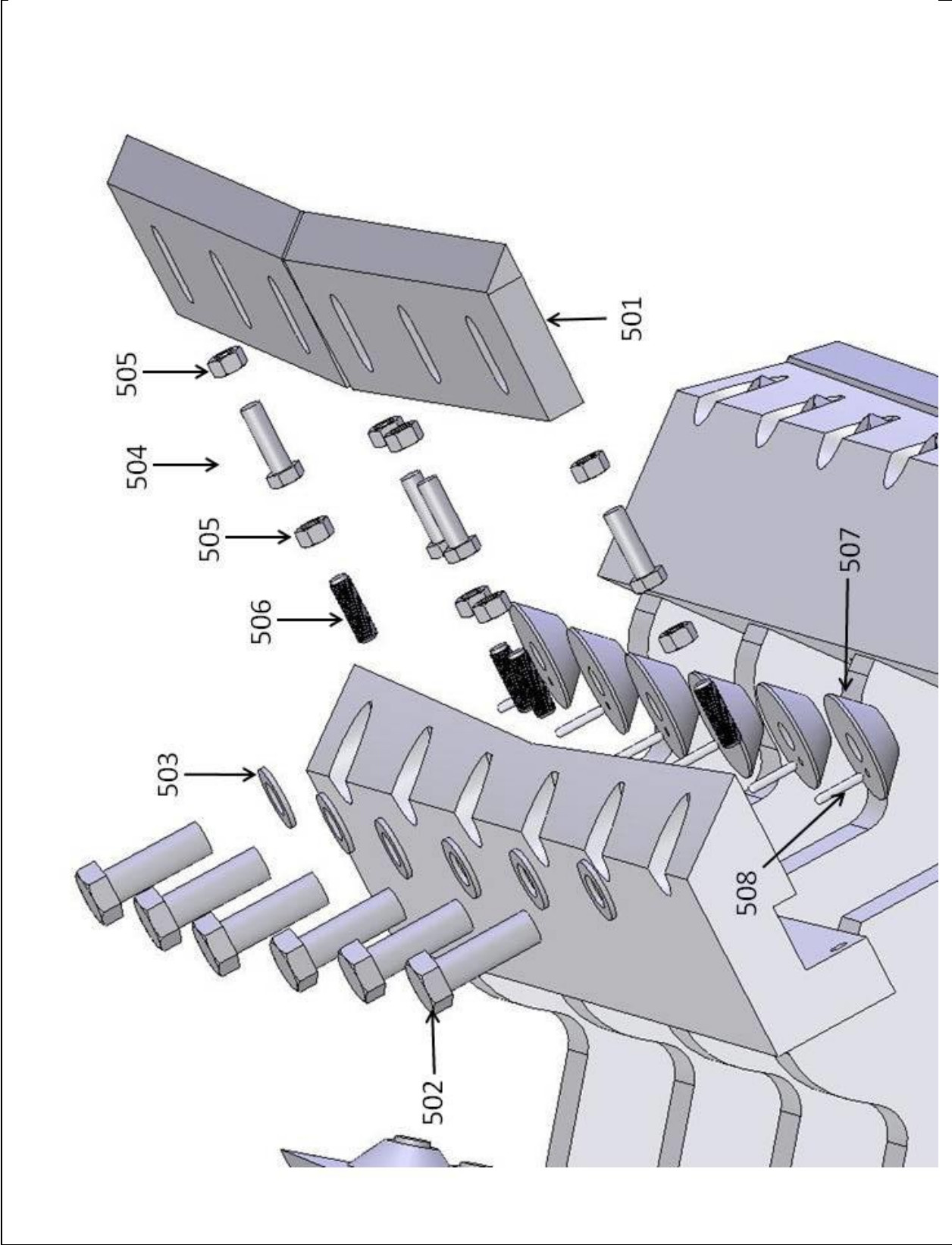

ORIGINAL INSTRUCTION
PART A: Basic machine
Granulator E 30 Series

Illustration: Stator knife fixing

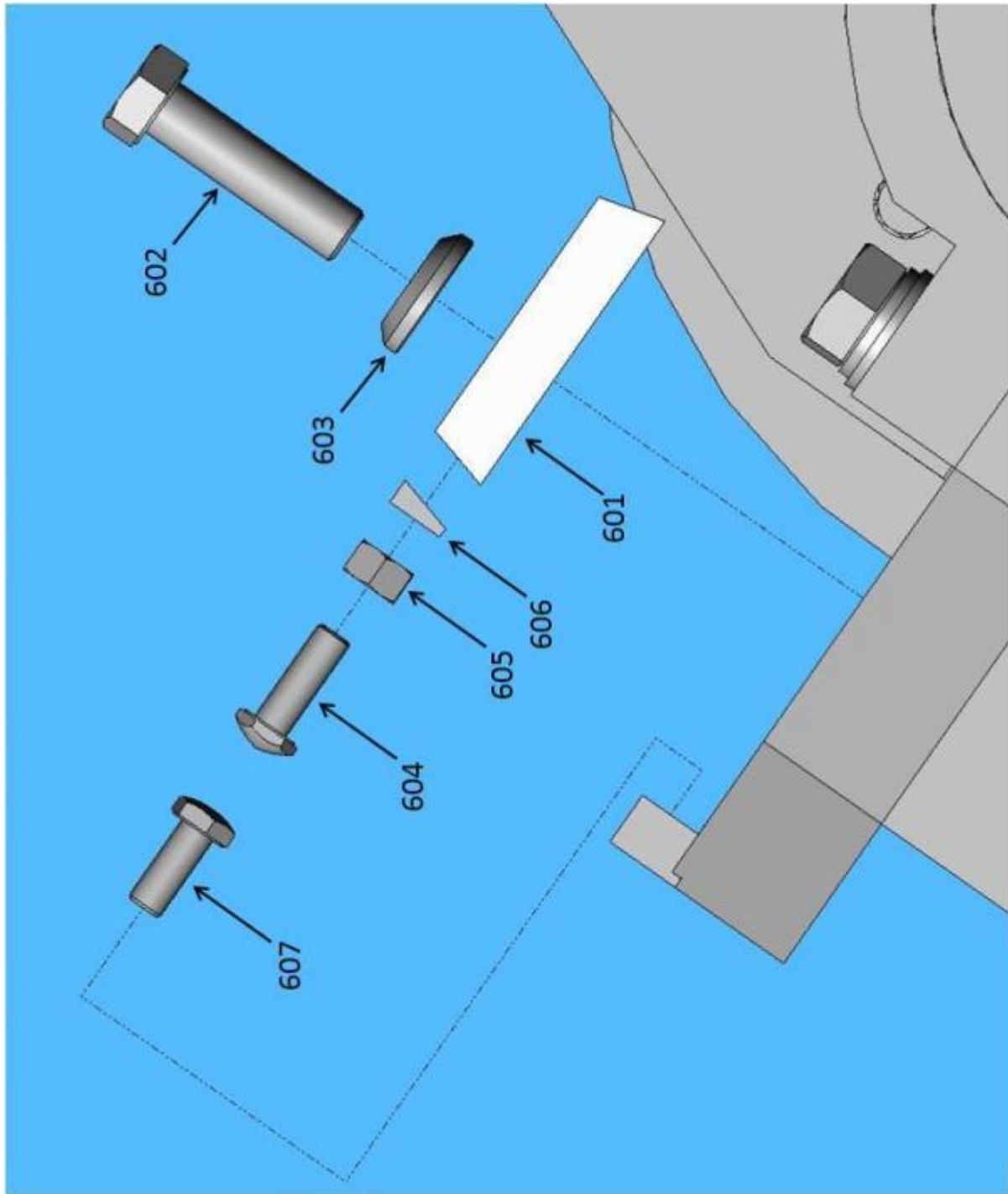

14 CLARIFICATION FOR PERSONAL TRAINING

This is to certify that I have attended an in company training for service and operation of the granulator and understand all safety regulations. Further to this I have read and understand the owners' manual.

City	Date	Printed name	Signature

15 ELECTRICAL CONNECTION

The machine should be wired by a qualified electrician.

Please refer to the wiring diagram.

ORIGINAL INSTRUCTION
PART A: Basic machine
Granulator E 30 Series

16 DIMENSIONS OF STANDARD MACHINE

16.1 E 30/30

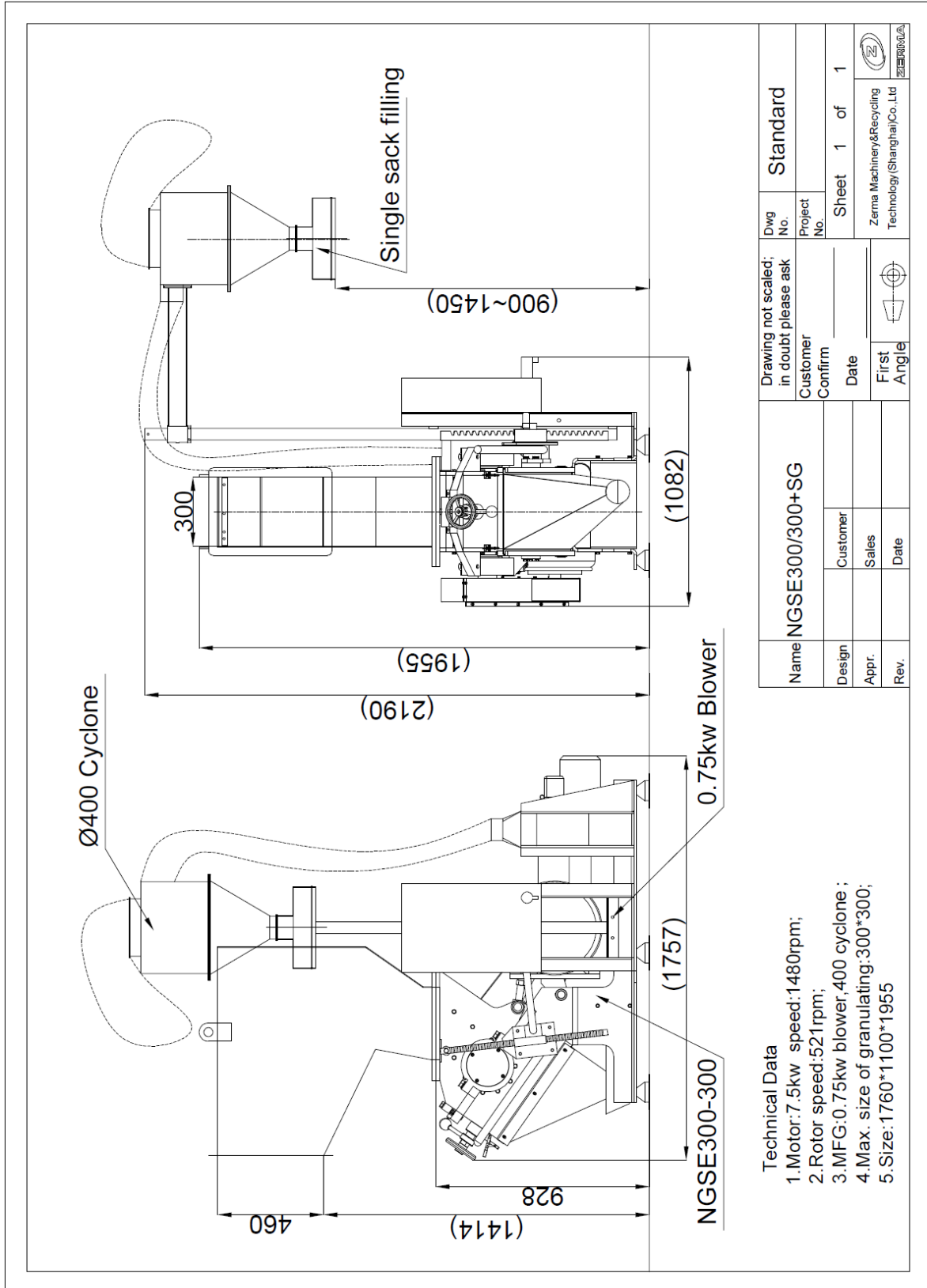

ORIGINAL INSTRUCTION
PART A: Basic machine
Granulator E 30 Series

16.2 E 30/60

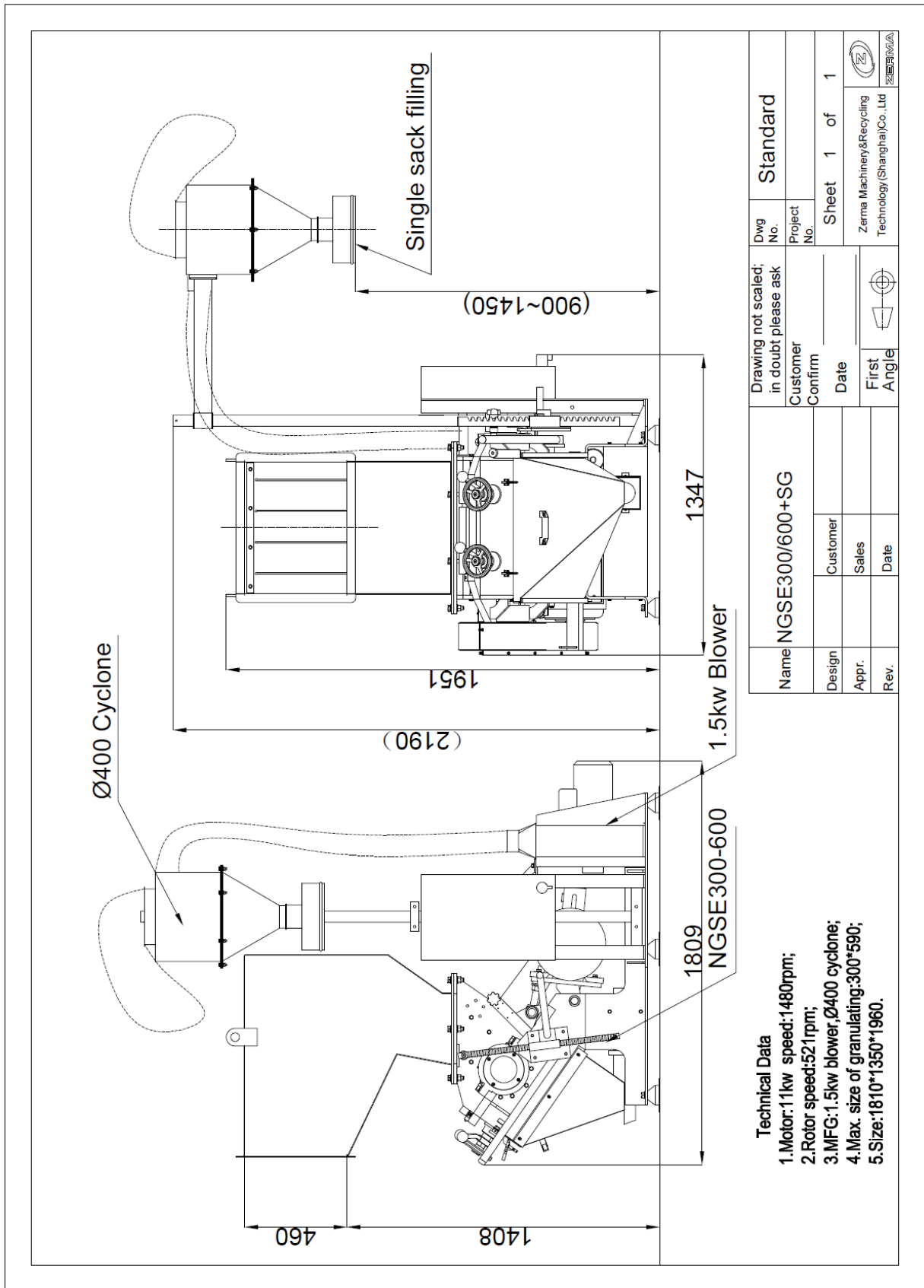

ORIGINAL INSTRUCTION
PART A: Basic machine
Granulator E 30 Series

16.3 E 30/100

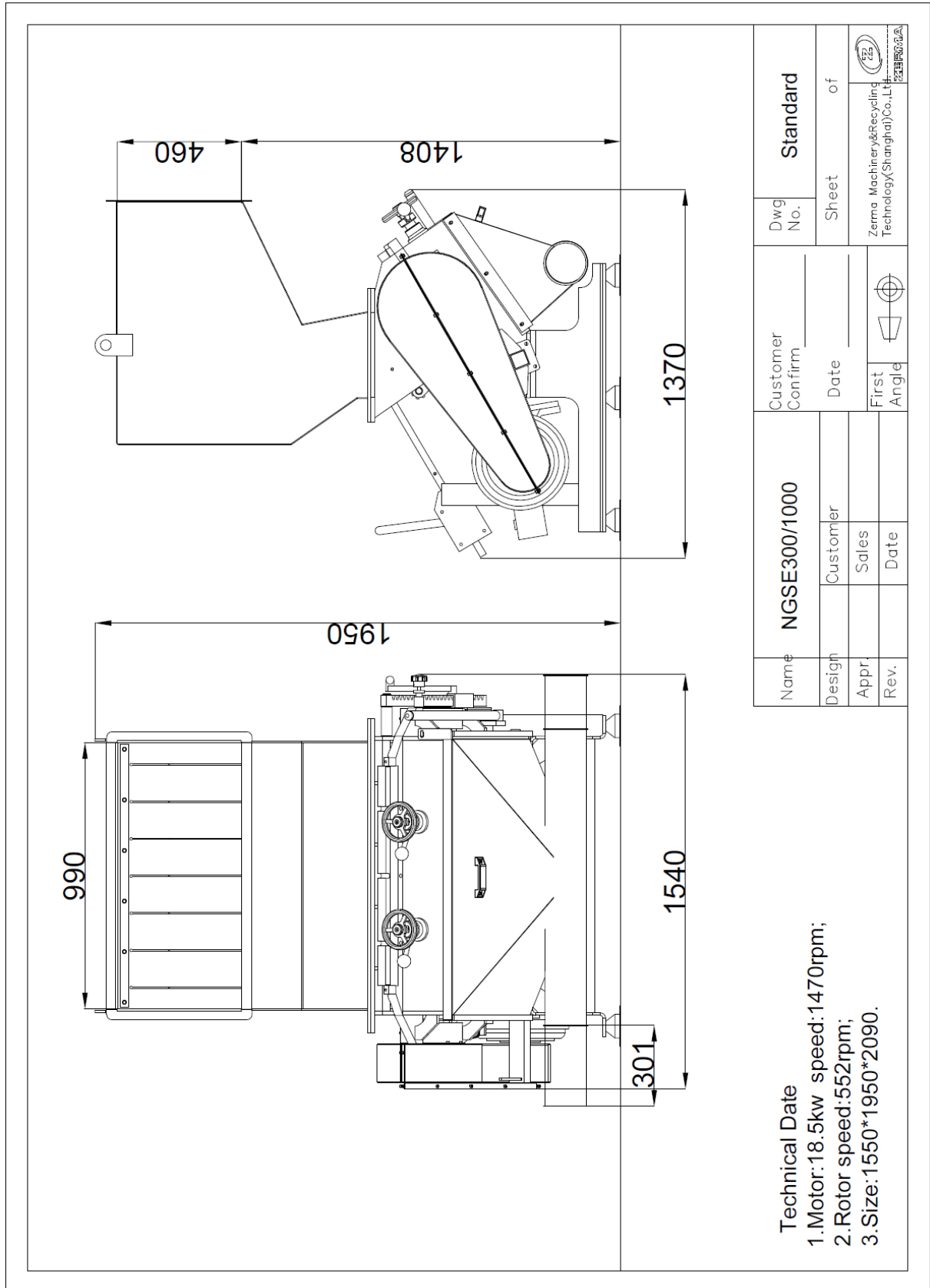

Technical Date
 1. Motor: 18.5kw speed: 1470rpm;
 2. Rotor speed: 552rpm;
 3. Size: 1550*1950*2090.

Name		NGSE300/1000		Customer Confirm		Dwg No.		Standard	
Design		Customer		Date		Sheet		of	
Appr.		Sales		First		 Zema Machinery & Recycling Technology (Shanghai) Co., Ltd. 浙江泽玛机械有限公司			
Rev.		Date		Angle					



17 ADDITION

Documentation Main Drive Granulator
(PART B)
Delivery documentation

ATTENTION:

The wiring schematics are located in the control panel in the event that the control panel is a part of the delivery