

# OPERATING MANUAL

## A18 SERIES

---



---

### **Virtus Equipment**

9120 Centerlinks Commerce Dr., Unit 4  
Fort Myers, FL 33912

239-219-1500  
Parts@Virtus-Equipment.com

[www.Virtus-Equipment.com](http://www.Virtus-Equipment.com)



The Right Machine for Today's  
Recycling Requirements





Staggered Rotor Blades



Quick Snap Fastening System

# ORIGINAL INSTRUCTION

## PART A: Basic machine

### Slow speed Granulator A18 Series

---

## Table of Contents

<b>1</b>	<b>Information on this instruction manual</b>	<b>7</b>
<b>2</b>	<b>Technical data</b>	<b>8</b>
<b>3</b>	<b>General Information</b>	<b>12</b>
3.1	Copyright	12
3.2	Application	12
3.3	Safety	12
3.4	Inspection of goods	12
<b>4</b>	<b>General safety advice</b>	<b>13</b>
4.1	Safe operation of the machine	13
4.2	Use in accordance with the regulations	14
4.3	Liability and Responsibility	16
4.4	Structural changes, spare parts, accessories	17
4.5	Operation manuals from other manufacturers	17
4.6	Noise levels and noise control measures	18
4.7	Work stations	18
<b>4.8</b>	<b>Remaining risks</b>	<b>19</b>
4.8.1	Mechanical dangers	19
4.8.2	Electrical dangers	20
4.8.3	Dangers caused by the control system	21
4.8.4	Thermal dangers	21
4.8.5	Dangers caused by noise	21
4.8.6	Dangers caused by vibration	22
4.8.7	Dangers caused by materials and substances	22
4.8.8	Danger caused by manipulation of the protective devices	22
<b>4.9</b>	<b>Protective devices</b>	<b>23</b>
4.9.1	Safety device for screen holder	23
4.9.2	Safety device for hopper	24
4.9.3	Safety device for suction trough	25
4.9.4	Splash guard	26
4.9.5	Safety markings	26
<b>4.10</b>	<b>Authorized persons</b>	<b>27</b>
<b>4.11</b>	<b>Personal protective gear</b>	<b>28</b>
<b>4.12</b>	<b>Safety measures at the application site</b>	<b>29</b>
<b>4.13</b>	<b>Fire fighting agents</b>	<b>29</b>
<b>4.14</b>	<b>Cleaning agents</b>	<b>29</b>
<b>4.15</b>	<b>Conduct in case of an emergency</b>	<b>29</b>
<b>4.16</b>	<b>Classification of specific safety advice</b>	<b>30</b>

# ORIGINAL INSTRUCTION

## PART A: Basic machine

### Slow speed Granulator A18 Series

---

<b>5</b>	<b>Description of the machine</b>	<b>31</b>
<b>5.1</b>	<b>Grinding material in feed</b>	<b>31</b>
5.1.1	In feed hopper	31
5.1.2	Additional in feed device	31
<b>5.2</b>	<b>Base frame</b>	<b>32</b>
<b>5.3</b>	<b>Drive</b>	<b>32</b>
<b>5.4</b>	<b>Granulator upper section/hopper</b>	<b>33</b>
<b>5.5</b>	<b>Granulator lower section</b>	<b>34</b>
5.5.1	Rotor and cutting knives	34
5.5.2	Screen and screen support	35
<b>5.6</b>	<b>Discharge of grinding material</b>	<b>36</b>
<b>6</b>	<b>Initial startup</b>	<b>37</b>
<b>6.1</b>	<b>General Advice</b>	<b>37</b>
<b>6.2</b>	<b>Requirements at the application site</b>	<b>37</b>
<b>6.3</b>	<b>Unloading and installing the machine</b>	<b>38</b>
6.3.1	Installing the machine with hopper Nr 3	39
<b>6.4</b>	<b>Electrical connection</b>	<b>40</b>
<b>6.5</b>	<b>Machine check prior to initial start-up</b>	<b>42</b>
<b>7</b>	<b>Operation</b>	<b>43</b>
<b>7.1</b>	<b>Machine checks before switching on the machine</b>	<b>43</b>
<b>7.2</b>	<b>Switch on machine</b>	<b>43</b>
<b>7.3</b>	<b>Switch off machine</b>	<b>44</b>
<b>7.4</b>	<b>Manual in feed of grinding material</b>	<b>44</b>
<b>8</b>	<b>Maintenance</b>	<b>45</b>
<b>8.1</b>	<b>Safety advice</b>	<b>45</b>
<b>8.2</b>	<b>Maintenance plan</b>	<b>45</b>
<b>8.3</b>	<b>Checking the protective devices</b>	<b>46</b>
<b>8.4</b>	<b>Opening and closing the hopper</b>	<b>47</b>
8.4.1	Opening the hopper	47
8.4.2	Closing the hopper	48
<b>8.5</b>	<b>Cleaning the machine</b>	<b>48</b>
<b>8.6</b>	<b>Replacing the main bearing</b>	<b>49</b>
8.6.1	Dismounting the main bearing	49
8.6.2	Mounting the main bearing	50
8.6.3	Lubricating the main bearings	51
8.6.4	Lubrication intervals:	51
8.6.5	Check lubricant quality	52
8.6.6	Replacing or refilling lubricant	52
8.6.7	List of lubricants	54

# ORIGINAL INSTRUCTION

## PART A: Basic machine

### Slow speed Granulator A18 Series

---

<b>8.7</b>	<b>Replacing the screen</b>	<b>55</b>
<b>8.8</b>	<b>Working on the cutting knives</b>	<b>57</b>
8.8.1	Replacing and checking the cutting knife mountings	57
8.8.2	Checking the condition of the cutting knives	58
8.8.3	Dismounting the cutting knives	59
8.8.4	Mounting the cutting knives	61
8.8.5	Sharpening cutting knives	62
8.8.6	Transporting and storing the cutting knives	65
<b>9</b>	<b>Troubleshooting</b>	<b>66</b>
<b>9.1</b>	<b>Machine blocks or switches itself off</b>	<b>66</b>
<b>9.2</b>	<b>Rotor does not grip bulky material</b>	<b>66</b>
<b>9.3</b>	<b>Overheating of the grinding material</b>	<b>66</b>
<b>9.4</b>	<b>Unusual vibrations</b>	<b>66</b>
<b>9.5</b>	<b>Extreme cutter wear</b>	<b>66</b>
<b>9.6</b>	<b>Bearings too hot</b>	<b>66</b>
<b>9.7</b>	<b>Too many fines in grinding material</b>	<b>67</b>
<b>9.8</b>	<b>Cutting gap alters during operation</b>	<b>67</b>
<b>9.9</b>	<b>Screen damage</b>	<b>67</b>
<b>9.10</b>	<b>Granulator does not start</b>	<b>67</b>
<b>9.11</b>	<b>Granulator blocks when under load</b>	<b>67</b>
<b>10</b>	<b>Storage, disposal, transportation</b>	<b>68</b>
<b>10.1</b>	<b>Storage</b>	<b>68</b>
<b>10.2</b>	<b>Disposal</b>	<b>68</b>
<b>10.3</b>	<b>Transportation</b>	<b>68</b>
<b>11</b>	<b>Customer service and spare parts orders</b>	<b>69</b>
<b>12</b>	<b>Spare Parts List A18/12</b>	<b>70</b>
<b>13</b>	<b>spare Parts List A18/18</b>	<b>72</b>
<b>14</b>	<b>Spare Parts List A18/30</b>	<b>74</b>
<b>15</b>	<b>Spare Parts List A18/43</b>	<b>76</b>
<b>16</b>	<b>Clarification for Personal Training</b>	<b>80</b>
<b>17</b>	<b>Standard machine layouts</b>	<b>81</b>
<b>17.1</b>	<b>A18/12</b>	
17.1.1	Hopper Nr 1, Frame Nr 1, Suction bin Nr 1	81
17.1.2	Hopper Nr 3, Frame Nr 1, Suction bin Nr 1	82
17.1.3	Hopper Nr 4, Frame Nr 1, Suction bin Nr 1	83
17.1.4	Hopper Nr 1, Frame Nr 2, Suction bin Nr 2	84
17.1.5	Hopper Nr 3, Frame Nr 2, Suction bin Nr 2	85
17.1.6	Hopper Nr 4, Frame Nr 2, Suction bin Nr 2	86

# ORIGINAL INSTRUCTION

## PART A: Basic machine

### Slow speed Granulator A18 Series

---

<b>17.2</b>	<b>A18/18</b>		
17.2.1	Hopper Nr 1, Frame Nr 1, Suction bin Nr 1	_____	87
17.2.2	Hopper Nr 3, Frame Nr 1, Suction bin Nr 1	_____	88
17.2.3	Hopper Nr 4, Frame Nr 1, Suction bin Nr 1	_____	89
17.2.4	Hopper Nr 1, Frame Nr 2, Suction bin Nr 2	_____	90
17.2.5	Hopper Nr 3, Frame Nr 2, Suction bin Nr 2	_____	91
17.2.6	Hopper Nr 4, Frame Nr 2, Suction bin Nr 2	_____	92
<b>17.3</b>	<b>A18/30</b>		
17.3.1	Hopper Nr 1, Frame Nr 1, Suction bin Nr 1	_____	93
17.3.2	Hopper Nr 3, Frame Nr 1, Suction bin Nr 1	_____	94
17.3.3	Hopper Nr 4, Frame Nr 1, Suction bin Nr 1	_____	95
17.3.4	Hopper Nr 1, Frame Nr 2, Suction bin Nr 2	_____	96
17.3.5	Hopper Nr 3, Frame Nr 2, Suction bin Nr 2	_____	97
17.3.6	Hopper Nr 4, Frame Nr 2, Suction bin Nr 2	_____	98
<b>17.4</b>	<b>A18/43</b>		
17.4.1	Hopper Nr 1, Frame Nr 1, Suction bin Nr 1	_____	99
17.4.2	Hopper Nr 3, Frame Nr 1, Suction bin Nr 1	_____	100
17.4.3	Hopper Nr 4, Frame Nr 1, Suction bin Nr 1	_____	101
17.4.4	Hopper Nr 5, Frame Nr 1, Suction bin Nr 1	_____	102
17.4.5	Hopper Nr 1, Frame Nr 2, Suction bin Nr 2	_____	103
17.4.6	Hopper Nr 3, Frame Nr 2, Suction bin Nr 2	_____	104
17.4.7	Hopper Nr 4, Frame Nr 2, Suction bin Nr 2	_____	105
17.4.8	Hopper Nr 5, Frame Nr 2, Suction bin Nr 2	_____	106
<b>18</b>	<b>Electrical Connection</b>	_____	<b>107</b>
<b>18.1</b>	<b>A18/12 Standard wiring diagram</b>	_____	<b>107</b>
<b>18.2</b>	<b>A18/18 Standard wiring diagram</b>	_____	<b>116</b>
<b>18.3</b>	<b>A18/30 and A18/43 Standard wiring diagram</b>	_____	<b>125</b>
<b>19</b>	<b>ADDITION</b>	_____	<b>134</b>

## **1 INFORMATION ON THIS INSTRUCTION MANUAL**

Author: Virtus Equipment

No part of this operation manual may be reproduced, distributed or used in any shape or form, stored in a data processing system or translated into another language without written permission.

This operation manual serves to help you to get to know your machine and how to make use of its application possibilities in accordance with the regulations.

The operation manual contains important information on how to operate the machine safely, correctly and economically. Following this advice will help you to avoid danger, minimize repair costs and down times and to increase the reliability and durability of the machine.

Before you begin to work on and with the machine, please read the operation manual thoroughly. Only after you have read and understood the contents of this operation manual may you begin work on and with the machine. Keep this operation manual at the application site for future reference.

References to chapters, plans and other documents as well as key markings are written in *italics*.

↓ Instructions on handling are marked in this way.

The machine is designed in modular system and offers a wide spectrum of variations to do justice to your expectations. In order that you receive with the delivery of your machine all the information relevant for you, this operation manual is divided into three parts:

1. Part A: Information of the basic machine.
2. Part B: Plans, operation manuals for systems from other manufacturers etc.

Should you wish to order further operation manuals, please quote the machine number.

We wish you every success with your new machine!



**ORIGINAL INSTRUCTION**  
**PART A: Basic machine**  
**Slow speed Granulator A18 Series**

---

**2 TECHNICAL DATA**

**A18/12**

Opening cutting chamber	Data in mm:	270x120
Rotor dimension:	Diameter in mm:	180
	Width of cut in mm:	120
Rotor knives:	No. of rotor knives:	12
Stator knives:	No. of stator knives:	2(4 edges)
Rotor speed (50 Hz):	rpm	200
Width:	Data in mm:	420
Length:	Data in mm:	850
Height:	Data in mm:	1050
Drive motor:	Power in kW:	2.2
Screen:	Type and screen hole size dependent on the application and customer requirements.	
Machine weight:	In kg	120
Electrical connection data:	markings are attached to the machine	
Noise level: Depends on plant location and type of grinding material!	Without noise equipment, in dB(A):	ca. 90

**ORIGINAL INSTRUCTION**  
**PART A: Basic machine**  
**Slow speed Granulator A18 Series**

---

**A18/18**

Opening cutting chamber	Data in mm:	270x180
Rotor dimension:	Diameter in mm:	180
	Width of cut in mm:	180
Rotor knives:	No. of rotor knives:	18
Stator knives:	No. of stator knives:	2(4 edges)
Rotor speed (50 Hz):	rpm	200
Width:	Data in mm:	420
Length:	Data in mm:	910
Height:	Data in mm:	1050
Drive motor:	Power in kW:	3.0
Screen:	Type and screen hole size dependent on the application and customer requirements.	
Machine weight:	In kg	130
Electrical connection data:	markings are attached to the machine	
Noise level: Depends on plant location and type of grinding material !	Without noise equipment, in dB(A):	ca. 90

**ORIGINAL INSTRUCTION**  
**PART A: Basic machine**  
**Slow speed Granulator A18 Series**

---

**A18/30**

Opening cutting chamber	Data in mm:	270x300
Rotor dimension:	Diameter in mm:	180
	Width of cut in mm:	300
Rotor knives:	No. of rotor knives:	30
Stator knives:	No. of stator knives:	2(4 edges)
Rotor speed (50 Hz):	rpm	200
Width:	Data in mm:	420
Length:	Data in mm:	1030
Height:	Data in mm:	1050
Drive motor:	Power in kW:	4.0
Screen:	Type and screen hole size dependent on the application and customer requirements.	
Machine weight:	In kg	150
Electrical connection data:	markings are attached to the machine	
Noise level: Depends on plant location and type of grinding material !	Without noise equipment, in dB(A):	Ca. 90

**ORIGINAL INSTRUCTION**  
**PART A: Basic machine**  
**Slow speed Granulator A18 Series**

---

**A18/43**

Opening cutting chamber	Data in mm:	270x430
Rotor dimension:	Diameter in mm:	180
	Width of cut in mm:	430
Rotor knives:	No. of rotor knives:	45
Stator knives:	No. of stator knives:	2(4 edges)
Rotor speed (50 Hz):	rpm	200
Width:	Data in mm:	420
Length:	Data in mm:	910
Height:	Data in mm:	1050
Drive motor:	Power in kW:	4.0
Screen:	Type and screen hole size dependent on the application and customer requirements.	
Machine weight:	In kg	170
Electrical connection data:	markings are attached to the machine	
Noise level: Depends on plant location and type of grinding material !	Without noise equipment, in dB(A):	Ca. 90

### **3 GENERAL INFORMATION**

#### **3.1 Copyright**

Virtus Equipment holds the copyright for these operation instructions, entrusted to the owner of the granulator for his personal use. These contains technical instructions and drawings which are not be copied complete or in part, distributed or used for reasons of unauthorized competition or for informing others.

#### **3.2 Application**

The granulator is designed for size-reduction of blow moulding parts such as PE, PP, and PVC etc. The user is responsible for consequences resulting from incorrect operation: This will lead to the loss of the warranty as well as any compensation claims.

#### **3.3 Safety**

The granulator has been constructed in accordance to the general standards of technology and is fitted with safety devices to prevent accidents that could endanger the life or health of the operator. The company operating the unit is responsible for the compliance of the safety regulations. We recommend staff training courses at regular intervals subsequent to initial training during commissioning.

#### **3.4 Inspection of goods**

The goods must be inspected by the purchaser to ensure that the delivery is complete and free from damage during transport. In the event of any queries Virtus must be informed with regard to missing items or transport damage. In the event of actual transport damage, written notification including photographs should be made and sent to the transport company as well as sent to Virtus immediately after delivery.

## **4 GENERAL SAFETY ADVICE**

### **4.1 Safe operation of the machine**

The machine is built according to the state of the art and recognised safety regulations.

It is equipped with protective devices; however there is still the threat of danger in case of incorrect conduct or misuse:

- for the health of the operator and that of other persons,
- for the machine,
- for the environment,
- for material assets belonging to the company and the operator.

All persons involved in:

- transportation and storage,
- start-up and shutdown,
- operation,
- setting and fitting
- maintenance and waste disposal...

of the machine must carefully read and take note of the following advice. However, not only the general safety advice listed in this chapter has to be observed, but also the safety advice which is added specifically in the other chapters.

Failure to heed this safety advice can lead to loss of all compensation claims.

Furthermore, the existing rules and regulations for the prevention of accidents as well as in house company working, operational and safety regulations have to be observed.

## **4.2 Use in accordance with the regulations**

The operational safety of the delivered machine is only guaranteed for use in accordance with the regulations!

This regulation use is only achieved if the following points are observed and fulfilled.

### **Manufacturing process and grinding material**

The granulator is suitable exclusively for the grinding of material, which corresponds to the agreed customer-specific specifications in all points (see *Contract of sale*).

Any other work or design will differ from the specified requirements. Virtus Equipment will not be held responsible. The specified requirements also include all information found in the owner's manual such as maintenance and service.

Any change in the specifications or requirements must be brought to the attention of Virtus.

### **Suction unit**

If emissions occur during grinding of material, which exceed the permissible legal values for contaminants in the air, the granulator may only then be operated when the customer on site has installed a suitable air suction device.

### **Safety device for the in feed hopper**

In the case that your design of granulator does not contain any additional in feed device (e.g. nip roll feed device), the in feed hopper must be safeguarded in a suitable way against persons reaching in or falling in.

### **Connection of the Emergency Stop button**

The machine may only be operated with the installed Emergency Stop buttons. In case no Emergency Stop buttons have been installed, an Emergency Stop button must be mounted on the control cabinet, the second on the material in feed.

# ORIGINAL INSTRUCTION

## PART A: Basic machine

### Slow speed Granulator A18 Series

---

#### **Miscellaneous:**

- The working conditions and instructions specified in this operation manual must be adhered to.
- The machine is not suitable for operation in an explosive environment.
- Faults, which can impair safety, are to be reported immediately and eliminated by a trained and skilled specialist.
- The machine may only be used in the industrial application range.

#### **General Requirements Safety Information**

- The service and maintenance in this owner's manual must be performed on a regular basis.
- The machine is not designed for operation in a volatile environment.
- Faults that could be a safety factor must be reported immediately and repaired by experienced personal.
- The machine must only be installed in a production type building.

#### **Known uses not in accordance with the regulations**

Never grind grinding materials, which do not correspond to the agreed customer-specific specifications. If this occurs, there is a danger to persons and the possibility of the machine being damaged.

#### **Informal Safety Requirements**

The owner's manual should always be located near the machine. New excerpts or additions to the owners' manual must always be replaced to include any safety requirements or environmental requirements.

All safety or caution signs must be visual and easy to read.





**ORIGINAL INSTRUCTION**  
**PART A: Basic machine**  
**Slow speed Granulator A18 Series**

---

### **4.3 Liability and Responsibility**

The General Conditions of Sale and Delivery basically apply. These conditions apply no later than the end of the contract. Liability and or responsibility to seller do not apply to the following;

- Equipment is not properly used for its specific application.
- Non-conforming installation, commissioning or service of the machines.
- Operation of the equipment without proper safety guards.
- Not conforming to the directions of the owners' manual regarding transport, storage, installation, commissioning or servicing the equipment.
- Any designs alterations on the machine.
- Any changes on the program logic which can alter the machine operation or electrical function.
- Changes in the logic function.
- In proper maintenance or serving the machines that can lead to extraordinary wear
- In proper serving of equipment
- Spontaneous crashes caused by foreign objects falling into the machine or acts of God

We honour a 12 month guarantee valid after delivery under the conditions that originally delivery or original parts from Virtus Equipment are used or accepted for use in accordance with our owner's manual.

Otherwise the guarantee will be considered invalid. Excluded are wear and tear parts such as knives, screens, drive belts, bearings, etc.

#### **4.4 Structural changes, spare parts, accessories**

For reasons of safety, remodelling and modifications to the machine, in particular to the electrical devices, are only permissible by arrangement with the manufacturer!

Replace faulty parts immediately. Only use original spare parts or spare parts from other manufacturers, which correspond, to the original spare parts with regards to function, stress and safety. This applies in particular for reasons of EMC (electro-magnetic compatibility) for electrical components.

The use of unsuitable parts can impair resistance to rays and increase the emission of rays!

If parts are replaced which are relevant for safety, they must be checked afterwards for proper functioning.

Only use accessories, which have been approved by the manufacturer. Use of accessories can change work with the machine. You must therefore observe the additional advice for your work and your safety. Read *Part B: Accessories*, before you commission the machine.

#### **4.5 Operation manuals from other manufacturers**

Integrated in the machine are systems from other manufacturers. When working on or with these systems, please observe the advice in the operation manuals from the respective manufacturer. These operation manuals are enclosed with the machine documentation.

#### **4.6 Noise levels and noise control measures**

The GSL series granulator standard design is without a sound proof enclosure.

The noise level of the granulator depends on location and type of grinding material.  
In order not to exceed the noise level of 85 dB(A) is the purchaser required to provide soundproofing.

The noise level can be affected by foundation static or dynamic, aux. blowers etc. or other additional equipment. Therefore it is necessary to actually determine if the noise level is directly coming from the machine or accessory equipment.

Virtus Equipment can supply equipment to reduce the noise levels.

### **CAUTION**



**The user or purchaser is responsible for compliance with the instructions and procedures!**

#### **4.7 Work stations**

During normal operation, the work station is the station at the in feed of the grinding material.

For maintenance work, the whole area around the machine is at your disposal.

**ORIGINAL INSTRUCTION**  
**PART A: Basic machine**  
**Slow speed Granulator A18 Series**

---

**4.8 Remaining risks**

The machine is constructed so that you are able to operate it safely. Structurally non-avoidable dangers are prevented as well as possible by the protective devices. A certain remaining risk does however always remain! Being aware of these remaining risks of the machine will help you to structure your work more safely and in so doing to avoid accidents.

To avoid danger, please observe in addition the specific safety advice in the individual chapters.

**4.8.1 Mechanical dangers**

<b>Type of danger:</b>	Danger of crushing by heavy parts falling down or falling over.
<b>Activity:</b>	Unloading and transporting the machine or machine components.
<b>Possible consequences:</b>	Serious injury could result.
<b>Preventative measures:</b>	Wear personal protective gear. Follow the instructions in this <i>Operation manual</i> .

<b>Type of danger:</b>	Danger of cutting caused by sharp cutting knives, even when the rotor is stationary.
<b>Activity:</b>	Knife replacement, knife setting, and knife sharpening, other maintenance work.
<b>Possible consequences:</b>	Serious injury, particularly to hands and fingers can result.
<b>Preventative measures:</b>	Wear personal protective gear. Follow the instructions in this <i>Operation manual</i> .

<b>Type of danger:</b>	Danger of crushing when closing the granulator upper section.
<b>Activity:</b>	Maintenance work.
<b>Possible consequences:</b>	Serious injury can result.
<b>Preventative measures:</b>	When closing the granulator upper section, ensure that no persons are in the danger area.

<b>Type of danger:</b>	Tripping over cables and other objects lying around.
<b>Activity:</b>	All activities.
<b>Possible consequences:</b>	Serious injury can result.
<b>Preventative measures:</b>	Lay cables in accordance with the regulations. Keep work station clean and tidy.

**ORIGINAL INSTRUCTION**  
**PART A: Basic machine**  
**Slow speed Granulator A18 Series**

<b>Type of danger:</b>	Danger of crushing, cutting and amputation caused by up to 3 minute run down of the rotor.
<b>Activity:</b>	Maintenance work.
<b>Possible consequences:</b>	Serious injury or death can result.
<b>Preventative measures:</b>	The housing upper section must always be tightly locked during operation using the connecting screws. Do not make the run down safety devices ineffective by using technical aids or other manipulations. Never check by hand whether the rotor has come to a stop.

**4.8.2 Electrical dangers**

<b>Danger:</b>	Direct or indirect contact with live parts in the terminal box.
<b>Activity:</b>	Maintenance work, start-up.
<b>Possible consequences:</b>	Serious injury or death.
<b>Preventative measures:</b>	<p>Trained electricians may only carry out all work on the electrical equipment.</p> <p>If work is necessary on parts, which conduct dangerous voltage, a second person should be called in who can break the power supply in case of emergency.</p> <p>The yellow-marked lines conduct voltage even when the machine is switched off (main switch to 0).</p> <p>Only use original safety fuses with stipulated intensity of current.</p> <p>Faulty electrical components must be replaced immediately.</p> <p>If faults occur in the electrical energy supply, switch machine off immediately.</p> <p>The terminal box must be locked during operation. Before opening the terminal box: Main switch to 0.</p>

**ORIGINAL INSTRUCTION**  
**PART A: Basic machine**  
**Slow speed Granulator A18 Series**

---

**4.8.3 Dangers caused by the control system**

<b>Type of danger:</b>	Danger caused by failure of the Emergency Stop function.
<b>Activity:</b>	All activities.
<b>Possible consequences:</b>	Serious injury or death.
<b>Preventative measures:</b>	It must be guaranteed that failure of an Emergency Stop button is displayed and leads to an immediate stop of the machine.

**4.8.4 Thermal dangers**

<b>Type of danger:</b>	Danger of fire and explosion caused by throwing dangerous objects (e.g. spray cans) into the granulator.
<b>Activity:</b>	Grinding.
<b>Possible consequences:</b>	Serious injury or death can result.
<b>Preventative measures:</b>	Only grind grinding material, which corresponds to the agreed customer-specific specifications in all points.

**4.8.5 Dangers caused by noise**

<b>Type of danger:</b>	Damage to hearing.
<b>Activity:</b>	All activities.
<b>Possible consequences:</b>	Diminished hearing, headaches, impaired balance, and deterioration of concentration.
<b>Preventative measures:</b>	Reduce noise emissions by taking suitable measures. Wear ear protection.

**ORIGINAL INSTRUCTION**  
**PART A: Basic machine**  
**Slow speed Granulator A18 Series**

---

**4.8.6 Dangers caused by vibration**

<b>Type of danger:</b>	Instability of the granulator caused by vibration.
<b>Activity:</b>	All activities.
<b>Possible consequences:</b>	Serious injury can result.
<b>Preventative measures:</b>	Install the machine according to the instructions of this <i>Operation manual</i> and the <i>Assembly drawing</i> .

<b>Type of danger:</b>	Loosening of the cutting knife mountings caused by vibration.
<b>Activity:</b>	All activities.
<b>Possible consequences:</b>	Serious injury can result.
<b>Preventative measures:</b>	Check the cutting knife mountings regularly according to the instructions in this operation manual.

**4.8.7 Dangers caused by materials and substances**

<b>Type of danger:</b>	Inhalation of grinding dust.
<b>Activity:</b>	All activities.
<b>Possible consequences:</b>	Diseases of the respiratory tract etc.
<b>Preventative measures:</b>	Mount a suitable air suction device. Wear breathing equipment if necessary. When cleaning the machine do not blow out grinding dust, use suction instead.

**4.8.8 Danger caused by manipulation of the protective devices**

<b>Type of danger:</b>	Danger of crushing, cutting and amputation.
<b>Activity:</b>	All activities.
<b>Possible consequences:</b>	Serious injury or death can result.
<b>Preventative measures:</b>	Never make the protective devices ineffective. Check the protective devices regularly for proper functioning according to the specifications given in this operation manual.

# ORIGINAL INSTRUCTION

## PART A: Basic machine

### Slow speed Granulator A18 Series

---

#### 4.9 Protective devices

The machine may under no circumstances be operated without these protective devices or with faulty or manipulated protective devices.

##### 4.9.1 Safety device for screen holder

Illustration:  
Safety device  
for screen holder

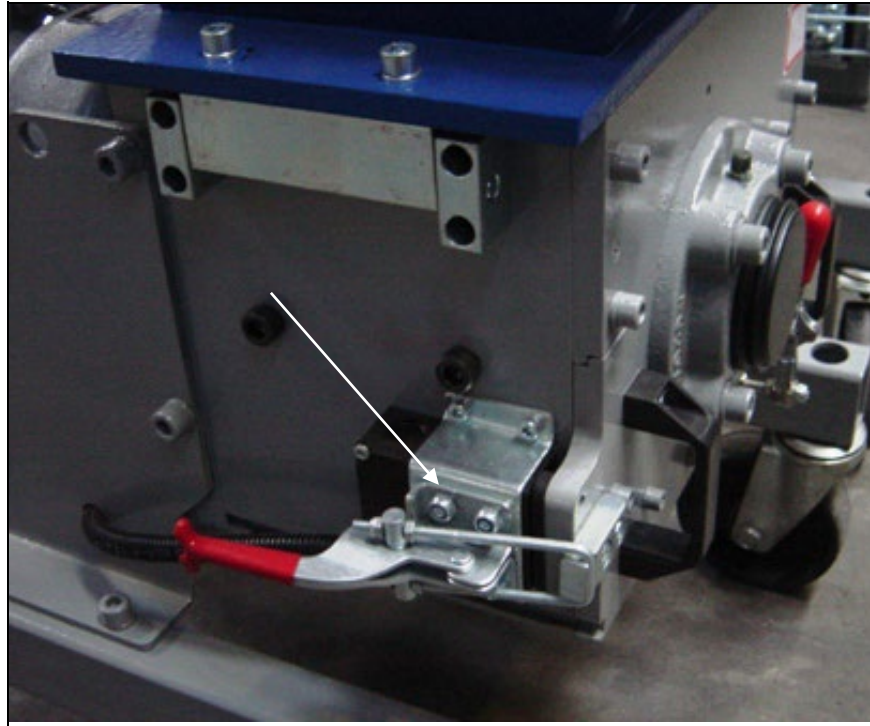

The granulator can only be operated if the screen holder is fixed and tightened with the clamps. Otherwise the safety switch is activated.

If the screen holder will be opened during operation, the safety switch is activated, thus switching off the machine.



# ORIGINAL INSTRUCTION

## PART A: Basic machine

### Slow speed Granulator A18 Series

---

#### 4.9.2 Safety device for hopper

Illustration:

- (1) Threaded spindle
- (2) Safety switch

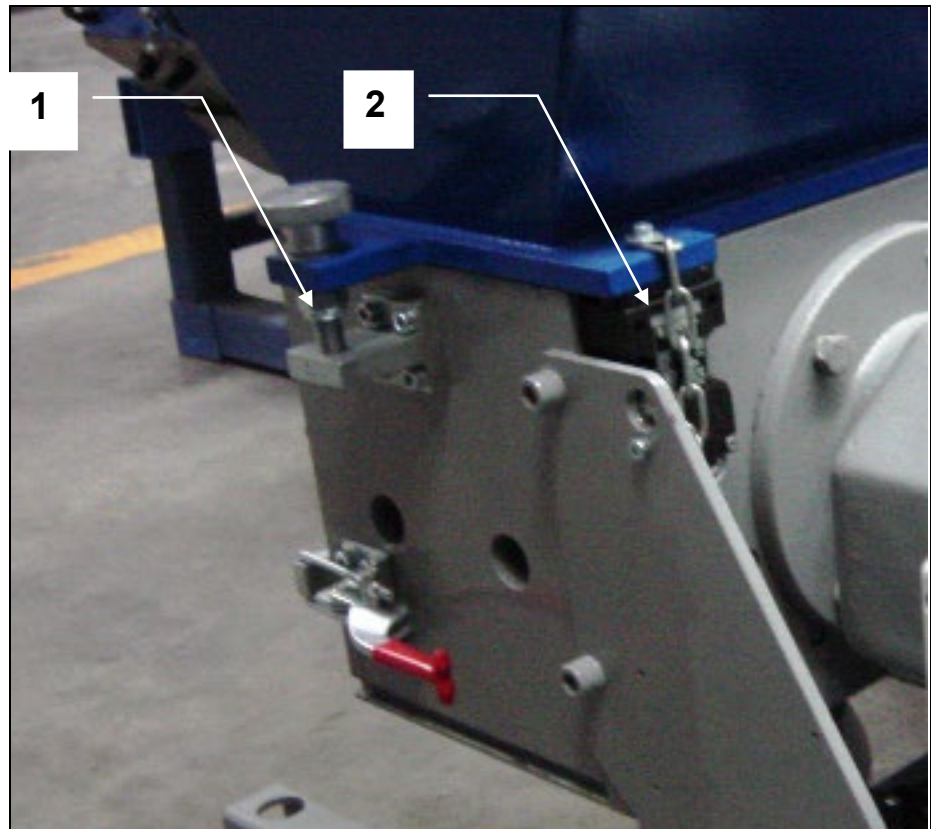

The hopper can be opened or pivoted upwards for maintenance work and for cleaning. It is connected with the cutting chamber by means of a joint.

Therefore the hopper is safeguarded against opening while running.

If the hopper will be opened during operation, the safety switch will be activated and the machine stops.

# ORIGINAL INSTRUCTION

## PART A: Basic machine

### Slow speed Granulator A18 Series

---

#### 4.9.3 Safety device for suction trough

Illustration:

Safety switch for:  
(1) Hopper  
(2) Suction trough

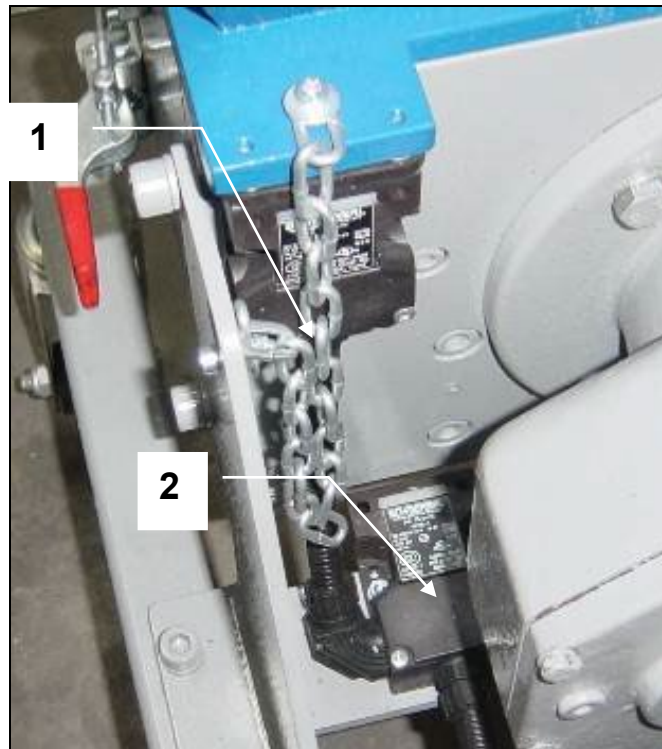
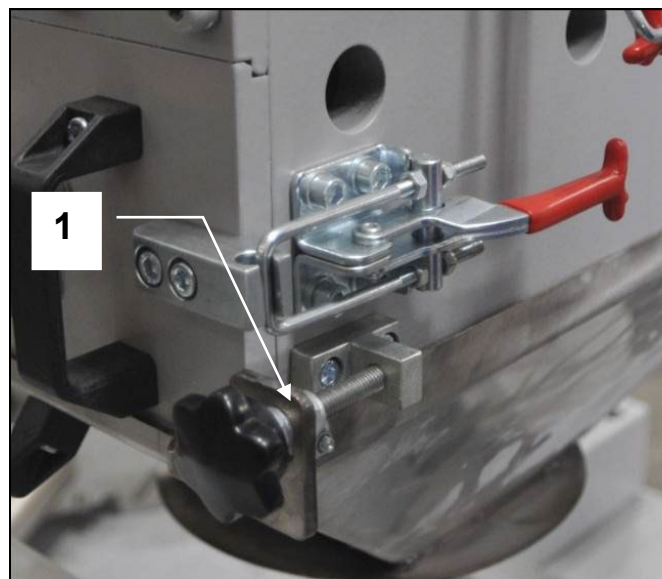

Illustration:

Safety switch for:  
(1) Threat spindle



The suction trough can be taken out for maintenance work and for cleaning.

The suction trough is equipped with a safety switch and a threat spindle for a time delay.

If the suction trough will be taken out during operation, by turning the threat spindle the safety switch will be activated and the machine stops.

# ORIGINAL INSTRUCTION

## PART A: Basic machine

### Slow speed Granulator A18 Series

---

#### 4.9.4 Splash guard

In case that the grinding material is introduced directly via the in feed hopper, the input opening is provided with a splash guard or folding plates to prevent flyout.

Illustration:  
Folding plate



#### 4.9.5 Safety markings

Safety markings are attached to the machine. If one of these markings becomes detached or is no longer recognisable, it must be replaced. You can order new markings at specialist shops or from us (see *Customer service and spare parts orders*).

**ORIGINAL INSTRUCTION**  
**PART A: Basic machine**  
**Slow speed Granulator A18 Series**

---

**4.10 Authorized persons**

Authorized personnel may only carry out work on the machine. Observe the legally permissible minimum age!

As a basic rule, persons who have received training on the machine may only operate the machine.

Personnel, who are still to be trained or receive instruction on the machine, may only work on the machine under constant supervision by an experienced person.

The company operating the machine must make the operation manual accessible to the machine user and ensure that he has read and understood it. Only then may he put the machine into operation.

Responsibility for the different jobs on the machine must be clearly established and adhered to. There must be no unclear areas of authority, as this could endanger the safety of the machine user.

If several persons work on the machine, a detailed division of workstations should be set up.

Trained electricians may only carry out all work on the electrical equipment.

Authorized specialist personnel may only eliminate faults on the control system.

All work related to installation, trained specialist personnel having received instruction on the machine might only carry out fittings and maintenance of the machine.

The operator must make sure that only authorized person's work on the machine. He is responsible for the safety of third persons in the working area of the machine.

**ORIGINAL INSTRUCTION**  
**PART A: Basic machine**  
**Slow speed Granulator A18 Series**

---

**4.11 Personal protective gear**

Wear close-fitting clothing. Jewellery and hair must be worn so that they cannot be pulled into the machine by moving parts.

**The following protective gear must be worn when carrying out the following tasks:**

	<b>Safety helmet</b>	<b>Safety boots</b>	<b>Safety gloves</b>	<b>Safety goggles</b>	<b>Ear muffs</b>
Unloading machine.	x	x	x		
Connecting machine.		x			
Operation.		x	x	x	x
Cleaning.		x	x	x	
Maintenance of bearings.		x			
Screen replacement.		x	x		
Maintenance of "V"-belts.		x			
Maintenance of cutting knives.		x	x		
Knife sharpening.		x	x	x	x

If necessary, protect yourself (in addition to the air suction device) with breathing equipment before inhaling substances harmful to the health.

#### **4.12 Safety measures at the application site**

Requirements at the application site: see chapter *Initial Start-up*.  
The machine must be erected horizontally on a horizontal surface and in a stable manner.  
Ensure by means of appropriate in house orders and controls that the environment of the work station is always clean and clear of obstructions.

#### **4.13 Fire fighting agents**

In the case of fire, disconnect the power supply of the machine or pull out the mains plug. Extinguish the fire from a distance of several meters using a fire extinguisher suitable for the machine and the grinding material.

#### **4.14 Cleaning agents**

Only use suitable cleaning agents to clean the machine and in doing so, the advice of the manufacturer is to be heeded. Please be aware that unsuitable cleaning agents (e.g. thinners) can damage the paint of the machine as well as the cables and plastic parts.

#### **4.15 Conduct in case of an emergency**

The machine may only be operated with the installed Emergency Stop buttons. An Emergency Stop button must be mounted onto the control cabinet, the second onto the grinding material in feed.

##### **Emergency Stop:**

- ↓ In case of emergency, immediately press one of the *Emergency Stop buttons*.

## **CAUTION**



**The EMERGENCY STOP must be activated in all situations whereby injury or damage could result!**

##### **Reoperation:**



- ↓ Eliminate cause of Emergency Stop.
- ↓ Unlock **EMERGENCY STOP BUTTON**.
- ↓ Acknowledge fault.  
The machine is now ready for operation again.



**ORIGINAL INSTRUCTION**  
**PART A: Basic machine**  
**Slow speed Granulator A18 Series**



---

**4.16 Classification of specific safety advice**

The specific safety advices in the following chapters of this operation manual are classified as follows:

 <b>DANGER</b>	
	Indicates an immediately threatening danger. If you do not take avoiding action, death or serious injury will result.

 <b>WARNING</b>	
	Indicates a possibly dangerous situation. If you do not take avoiding action, death or serious injury could result.

 <b>CAUTION</b>	
	Indicates a possibly dangerous situation. If you do not take avoiding action, slight or minor injury could result.

This safety advice refers to the remaining risks for certain working steps and helps you to work safely with the machine. In addition to the safety advice above, there are also the hint and the tip.

**HINT**



Indicates a possibly harmful situation. If you do not take avoiding action, the machine could be damaged.

**TIP**





Indicates application tips and other particularly useful information.

## **5 DESCRIPTION OF THE MACHINE**

### **5.1 Grinding material in feed**

The grinding material can be fed into the granulator in the following ways:

- Manual in feed of the grinding material directly into the in feed hopper.
- Manual in feed of the grinding material with the help of an additional in feed device (e.g. nip roll feed device).
- Automatic in feed of the grinding material by means of an additional in feed device (e.g. conveyor belt).

 <b>WARNING</b>	
	<b>The machine is not allowed to manually feed cut film, fibers, strands or similar materials. Risk of to cause entanglement</b>

#### **5.1.1 In feed hopper**

The grinding material in feed ensues via an in feed hopper, which is formed so that the grinding material can be delivered correctly and safely. A splashguard at the input opening prevents thrown-back parts being able to escape. The grinding material in feed can take place manually or with the help of an additional in feed device.

#### **5.1.2 Additional in feed device**

If your machine has an optional in feed device such as roller feeder or conveyor belt please refer to the additional information about the accessories in the appendix.



# ORIGINAL INSTRUCTION

## PART A: Basic machine

### Slow speed Granulator A18 Series

---

#### 5.2 Base frame

Illustration:

- (1) Base frame
- (2) Gear motor
- (3) Hopper
- (4) Cutting chamber
- (5) Suction trough
- (6) Wheels

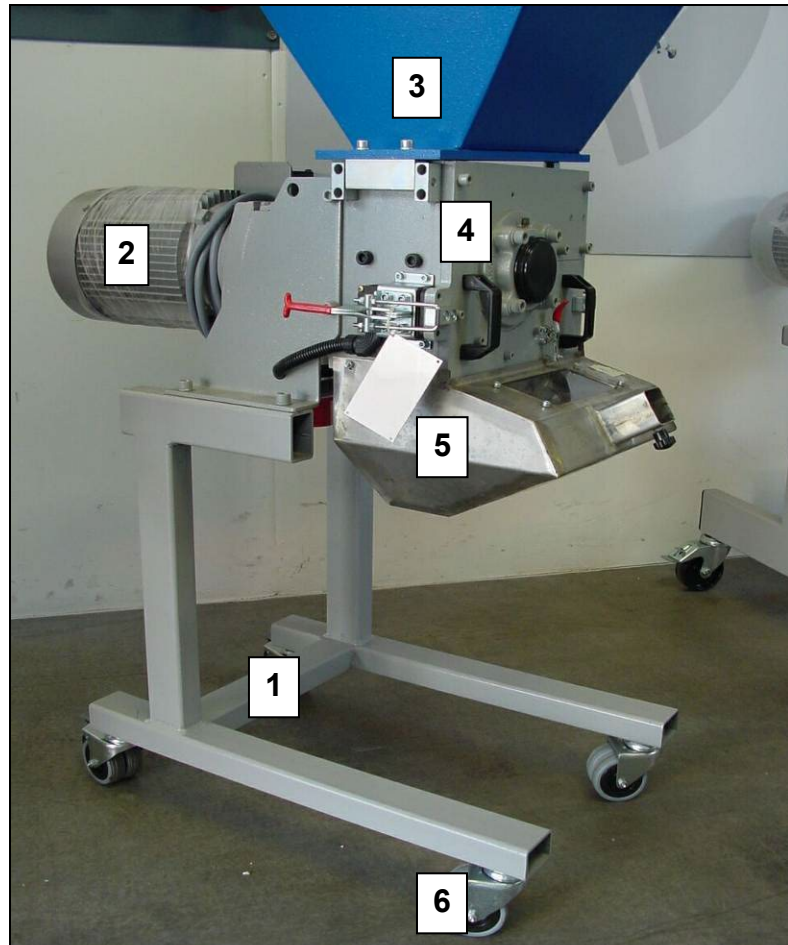

The granulator, the suction trough and the drive motor are mounted on the base frame.

The base frame is equipped with wheels.

#### 5.3 Drive

The drive of the rotor ensues by means of an electric helical gear motor. The motor is flanged on the cutting chamber.

Please observe the operation manual from the manufacturer!

**ORIGINAL INSTRUCTION**  
**PART A: Basic machine**  
**Slow speed Granulator A18 Series**

---

**5.4 Granulator upper section/hopper**

The hopper can be opened by hand for maintenance work and for cleaning. It is connected with the granulator lower section by means of a joint.

Illustration:  
Hopper (opened)



**ORIGINAL INSTRUCTION**  
**PART A: Basic machine**  
**Slow speed Granulator A18 Series**

---

**5.5 Granulator lower section**

The cutting chamber is mounted onto the base frame. The motor is flanged onto the cutting chamber. On the motor shaft the rotor stars are mounted. The end of the drive shaft sits in a flange bearing, which is mounted on the cutting chamber. The bearings lie outside the grinding chamber and are sufficiently sealed off against penetrating dirt.

The stator knives which are installed in the cutting chamber are easily accessible and simple to install and dismantle.

The ground material falls through a screen into the suction trough mounted underneath the rotor and can be sucked off from there.

**5.5.1 Rotor and cutting knives**

Abbildung:

- (1) Stator knives
- (2) Rotor knives
- (3) Scraper
- (4) Screen
- (5) Screen holder bars

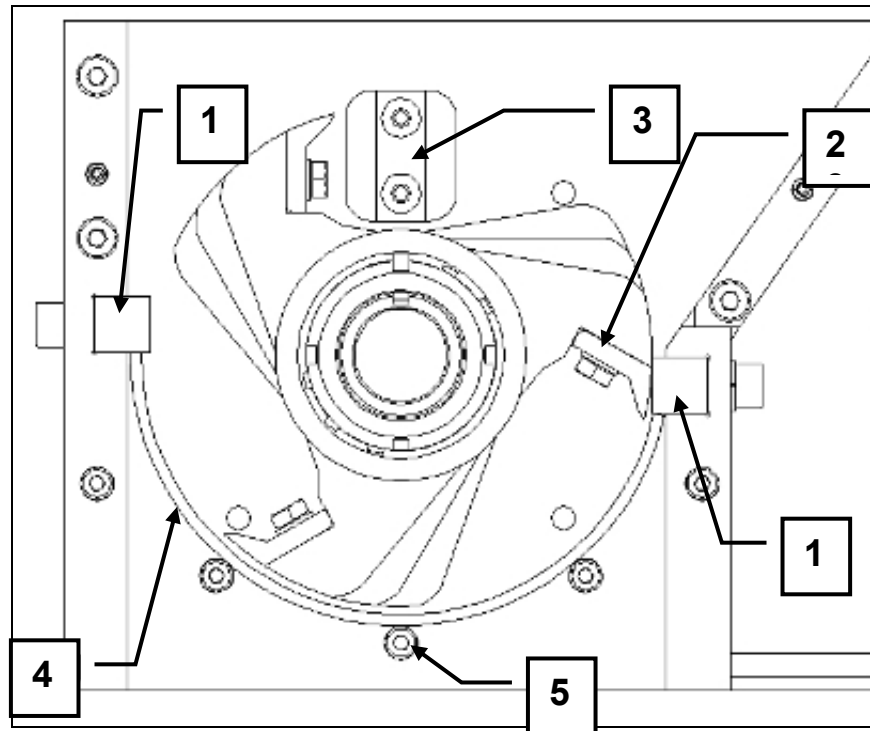

The material is ground between the knives assembled on the rotor and the stator knives which are mounted in a fixed position in the housing.

Scrapers are placed on both side walls of the cutting chamber.

The design of the rotor has a significant influence on the quality of the grinding process and its results. The rotor construction, the type of knife mounting and the number of knives have all been exactly matched to your task allocation.

The rotor is accessible after opening the hopper.

# ORIGINAL INSTRUCTION

## PART A: Basic machine

### Slow speed Granulator A18 Series

---

#### 5.5.2 Screen and screen support

The screen lies in the screen support below the rotor. This screen support is fixed in the sidewall of the cutting chamber. It can be removed by opening the clamps.

Illustration:  
(1) Screen

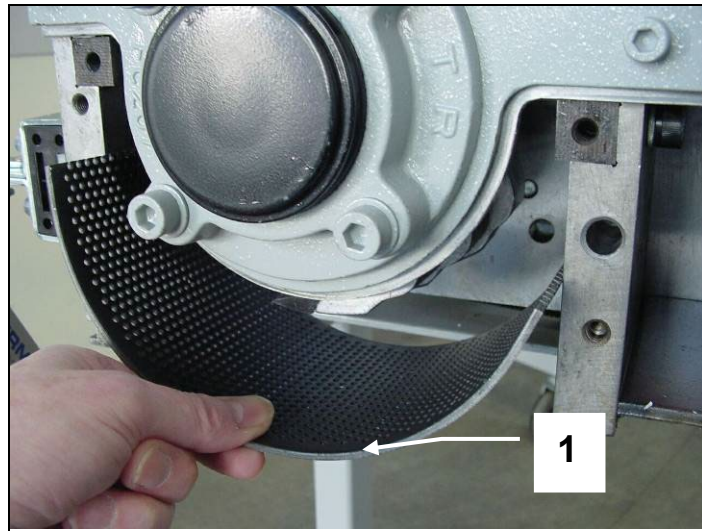

The screen is slightly larger in its radius than the cutting circle of the rotor knife. The screen perforation is selected according to the desired grain size of the grinding material.

All grinding material parts which are smaller than the screen perforation fall through the screen into the suction trough. The screen is replaceable and can be taken out after the suction trough and the screen holder are taken out.

Illustration:  
(2) Screen support

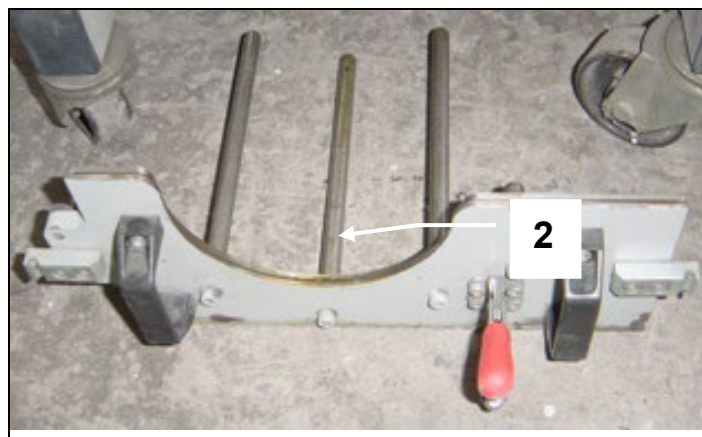

**ORIGINAL INSTRUCTION**  
**PART A: Basic machine**  
**Slow speed Granulator A18 Series**

---

**5.6 Discharge of grinding material**

Illustration:

Suction trough



The ground material is sucked off by means of a blower (Accessories) out of the suction trough of the granulator. If the granulator is equipped with a high frame, the ground material can be collected in a box below the cutting chamber.

## **6 INITIAL STARTUP**

### **6.1 General Advice**

**All work related to start-up may only be carried out by trained specialist personnel.**

**Check the machine for possible transportation damage or other damage. Should you determine damage, have this confirmed by the freight company and please report this to us in writing immediately after delivery. When starting up for the first time and after setting up ready for service, you must carry out the necessary checks according to the chapter *Machine check prior to initial* .**

### **6.2 Requirements at the application site**

The site of application for the machine must exhibit the following features:

- Enclosed space.
- The ground must exhibit sufficient load-bearing capacity (you can find the machine weight in the *Chapter Technical Data*). The unevenness of the ground surface may not exceed 5 mm.
- The machine must be freely accessible from all sides.
- There must be sufficient room available for operating and service personnel.
- Spatial requirements: see *Assembly drawing*. All hinged parts must be able to be opened completely.
- Vibration-free environment.
- The application site must be well-lit.
- The machine may not be exposed to direct radiation caused by radiators or the sun.
- Room temperature: +5° to +40°C
- Relative atmospheric humidity according to DIN 40040:  
15 to 70 % (indoor)  
By humidity levels higher than 70 %, apply anticorrosive agent to the metallic-finished machine parts. Insulation for the tropics is also necessary.
- The machine may not be operated within range of static discharges or strong magnetic fields as this could lead to faults in the machine control system.





**ORIGINAL INSTRUCTION**  
**PART A: Basic machine**  
**Slow speed Granulator A18 Series**



---

### 6.3 Unloading and installing the machine

The machine or the machine components are packed so that they arrive with you safely. To see how the machine is packed or should be packed, please see the *Packing plan*. For unloading the packaged machine or machine components you may use a suitable crane or forklift truck.

 <b>WARNING</b>	
	<b>Suspended load.</b> <b>Falling loads can cause serious injury or death.</b> <b>Only use a crane or a forklift truck which is suitable for the weight and the dimensions of the load.</b>
	<b>Also use a suitable stopping means and pay attention to the gravity centre location.</b> <b>Do not step under the suspended load.</b> <b>Wear a safety helmet in addition to your basic protective gear.</b>

- ↓ After unloading, remove the packaging material and all transportation safety devices.
- ↓ In the case that the granulator and its accessory components have been delivered as individual items, mount these at the site of application using the mounting screws sent with the delivery exactly in accordance with the data given in the *Assembly drawing*. Only in this way can it be guaranteed that there are sufficient delivered piping parts, tubing and cable connections and that the linking places match.

 <b>WARNING</b>	
	<b>Overtipping or falling machine.</b> <b>Serious injury or death can result.</b> <b>In the case that you wish to erect the granulator over a pit, on a frame or on a platform, you must secure the machine by putting mounting screws through the holes on the mounting pads (see <i>Assembly drawing</i>). If assembling the machine on solid ground, this safety device is not absolutely necessary.</b>

- ↓ Align the machine horizontally with the help of a suitable spirit level.  
Do not use blocks to place underneath the machine, use instead metal strips in order to prevent buckling of the base frame. Make sure that an even distribution of weight is achieved on all the points of support.

# ORIGINAL INSTRUCTION

## PART A: Basic machine

### Slow speed Granulator A18 Series

#### 6.3.1 Installing the machine with hopper Nr 3 and frame Nr 1

For a Safe installation according machine directive 2006/42/EC, if using hopper Nr 3, the machine need installed with safety guards according ISO EN 13857 (4.2.2.1.2 Table 2) with following safety distances for a safe operation.

Illustration:  
Side fence  
installation according  
ISO13857 for hopper  
NR 3

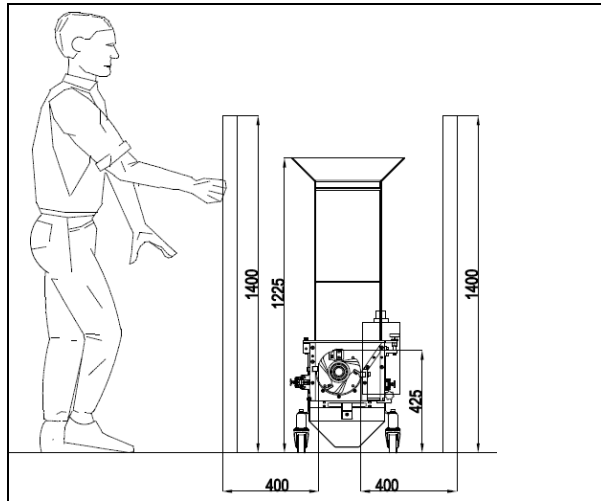
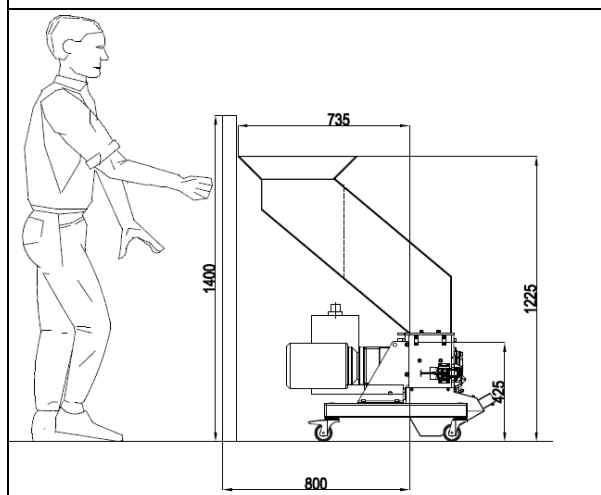

Illustration:  
Front fence  
installation according  
ISO13857 for hopper  
NR 3



1. Move the control box out of fence; operator can control the machine in the safety place  
If the operator need enter the fence to check the machine.
2. Please install a door with interlock guard with guard locking, to avoid the operator enter the fence and machine still running



<b>! DANGER</b>	
	<b>Rotating knives.</b> <b>Can cause serious cutting and crushing injuries, possibly leading to death.</b> <b>You shall not stay between safety fence and machine during the machine is running.</b>



**ORIGINAL INSTRUCTION**  
**PART A: Basic machine**  
**Slow speed Granulator A18 Series**



---

**6.4 Electrical connection**

 <b>WARNING</b>	
	<p><b>Dangerous voltage.</b> <b>Touching live parts can lead to serious injury or death.</b> <b>All work which relates to the electricity of the machine may only be carried out by trained electricians.</b> <b>Observe the currently effective EMC regulations.</b></p>

Voltage, current, frequency and protection are marked on the *Type plate*. The voltage tolerance is  $\pm 10\%$ .

- ↓ For machines, which have been supplied none pre-wired by VIRTUS the electrical connection, is to be carried out in accordance with the enclosed *Wiring diagram* in the terminal box. When doing this, the regulations of the local electricity authority are to be adhered to. The cable cross section required is to be determined according to the rated capacity of the units.

 <b>WARNING</b>	
	<p><b>When operating specific equipment caution must be taken to prevent electrical shock. Installation, service, alterations and or modifications must only be done by qualified personal and with up most safety. Not conforming to the requirements could result in bodily injury, death or costly damage.</b></p>

**HINT**



Alterations to the wiring diagrams from VIRTUS require our approval. Failure to do this will exclude all guarantee claims.

The wiring schematics are located in the control panel in the event that the control panel is a part of the delivery.

**ORIGINAL INSTRUCTION**  
**PART A: Basic machine**  
**Slow speed Granulator A18 Series**

---

**Connection of Emergency Stop button**

The machine may only be operated with installed Emergency Stop buttons. In the case that no Emergency Stop buttons have been installed at the factory, an Emergency Stop button must be installed at the control cabinet, the second at the grinding material in feed.

**Checking the rotational direction**

Checking the rotational direction is part of the machine checks before initial start-up (see chapter of same name). The steps prior to this check must be carried out beforehand.

- ↓ Switch the machine on and then immediately off again for a short time (see *Switch on machine* and *Switch off machine*).
- ↓ Observe whether the discharge air fan in the drive motor is rotating in the direction of the attached direction arrow.

**HINT**



**If running in the wrong direction, reconnect the motor connection immediately. Damage to the machine will result from operation in the wrong direction.**

**ORIGINAL INSTRUCTION**  
**PART A: Basic machine**  
**Slow speed Granulator A18 Series**

**6.5 Machine check prior to initial start-up**

<b>Check</b>	<b>See chapter</b>
1. When granulator is open, check the knife mounting screws using a torque wrench.	<i>Replacing and checking the cutting knife mountings.</i>
2. Search the grinding chamber for foreign matter.	<i>Cleaning the machine.</i>
3. Open the suction trough on the housing lower section and check whether the screen has been inserted in accordance with the regulations.	<i>Emptying the screen</i>
4. Close granulator upper section and fasten screws tightly.	<i>Opening and closing the granulator.</i>
5. Examine in feed device (accessories) for foreign matter.	<i>Part B: Accessories.</i>
6. Check that the <i>Emergency Stop buttons</i> are unlocked.	
7. Check all safety devices for proper functioning.	<i>Checking the protective devices.</i>
8. Switch on machine for a short time and check rotational direction. The rotational direction can be seen at the discharge air fan of the drive motor (observe running direction arrow).	<i>Installing the machine.</i>
9. Allow machine to run for approx. 10 minutes without grinding material.	<i>Switch on machine.</i>
10. Connect material blower (accessories) and in feed device (accessories), check rotational direction of blower.	<i>Part B: Accessories.</i>
11. Feed grinding material uniformly. Too much grinding material can lead to overload of the machine.	<i>Manual in feed of grinding material.</i>
12. If necessary, check the temperature of the ground material.	

## **7 OPERATION**

Have you read and understood the operation manual, in particular the safety advice in the chapter on?  
You may not operate the machine until you have done so!

### **TIP**



Should faults occur during work with the machine, please observe the advice in the chapter *Troubleshooting*.

### **7.1 Machine checks before switching on the machine**

<b>Check</b>	<b>See</b>
1. The knives are properly set and the screws are tightened with the specified torque.	<i>Replacing and checking the cutting knife mountings.</i>
2. The screen is inserted into the screen support in accordance with the rules and the screen support is held fixedly at the end position due to the tightened mounting screws.	<i>Emptying the screen. Replacing the screen.</i>
3. The grinding chamber is free of foreign matter.	<i>Cleaning the machine.</i>
4. The suction trough below the screen support is closed.	<i>Emptying the screen. <b>Error! No bookmark name given.</b> Replacing the screen.</i>
5. The hopper is closed.	<i><b>Error! Not a valid result for table.</b></i>
6. All safety devices including those of the installed grinding material in feed and discharge devices are checked and operative.	<i>Checking the protective devices.</i>

### **7.2 Switch on machine**

1. Switch on the grinding material discharge device (accessories).
2. Switch on the granulator (main switch to 1).
3. Switch on the grinding material in feed device (accessories).



**ORIGINAL INSTRUCTION**  
**PART A: Basic machine**  
**Slow speed Granulator A18 Series**

---

**7.3 Switch off machine**

- 1. Switch off the grinding material in feed device (accessories).
- 2. Wait until the remaining grinding material has been ground, then switch off the granulator, (main switch to 0).
- 3. Switch off the grinding material discharge device (accessories).

**7.4 Manual in feed of grinding material**

 <b>DANGER</b>	
	<p><b>Rotating knives.</b> <b>Can cause serious cutting and crushing injuries, possibly leading to death.</b> <b>Do not reach into the in feed hopper or lean in whilst the rotor is running (pay attention to the 3 minute run down time). Only use approved grinding material.</b></p>

↓ Throw the grinding material into the grinding chamber through the splash guard.



If in your design of machine an additional in feed device is installed, please observe the additional information for work with and on the in feed device *Part B: Accessories*.

**ORIGINAL INSTRUCTION**  
**PART A: Basic machine**  
**Slow speed Granulator A18 Series**

**8 MAINTENANCE**

**8.1 Safety advice**

Trained specialist personnel may only carry out work included within the framework of maintenance.  
 Carry out the maintenance work within the specified time and document this. The machine will thank you for this by providing high reliability.

 <b>WARNING</b>	
	<b>Danger caused by electrical voltage and starting the machine during maintenance work. Mortal danger.</b>
	<b>Therefore, as a basic rule when carrying out maintenance work: Main switch to 0, safeguard using padlock and attach a warning sign.</b>

**8.2 Maintenance plan**

The tasks for maintenance work are described in detail in this chapter.

Maintenance work	Oh = Operation hours		
	Every 7 Oh	Every 35 Oh	If necessary
Check protective devices for proper functioning.	x		
Clean machine.			x
Check cutting knife mountings.	x		
Check the main bearings (bearing clearance, lubricant renewal).			x
Lubricant replacement, lubricant renewal	<b>See <i>Lubrication intervals</i>:</b>		
Check "V"-belt tension force and "V"-belt condition.		X	
Check condition of cutting knives.	x		
Check all screws of the machine for a tight fit.		X	
Check wearing parts.		X	

**Yearly maintenance**



The purpose of yearly maintenance of the machine is primarily to check the general condition of the machine and to arrange for the supply of any necessary replacement parts in good time. A service engineer from Virtus Equipment can also carry this out on request.

### 8.3 Checking the protective devices

For this, see also the chapter *Protective devices*.

Check the safety devices for:

- Stipulated condition,
- Stipulated location,
- Safe mounting,
- Stipulated function.

 <b>WARNING</b>	
	<p><b>Danger due to non-functioning protective devices.</b> <b>Serious injury or death can result.</b></p> <ul style="list-style-type: none"><li>• <b>Eliminate all defects before you put the machine into operation!</b></li><li>• <b>If defects occur during operation, stop the machine immediately and eliminate the defects!</b></li><li>• <b>Do not change or remove any protective devices. Do not put any protective devices out of action by modifying them.</b></li></ul>

**ORIGINAL INSTRUCTION**  
**PART A: Basic machine**  
**Slow speed Granulator A18 Series**

---

**8.4 Opening and closing the hopper**

The hopper can be opened by hand for maintenance work and for cleaning. It is connected with the granulator lower section by means of a joint.

**8.4.1 Opening the hopper**

**Proceed as follows:**

- ↓ Switch off the granulator at the main switch, safeguard main switch using a padlock.
- ↓ Open the threaded spindle

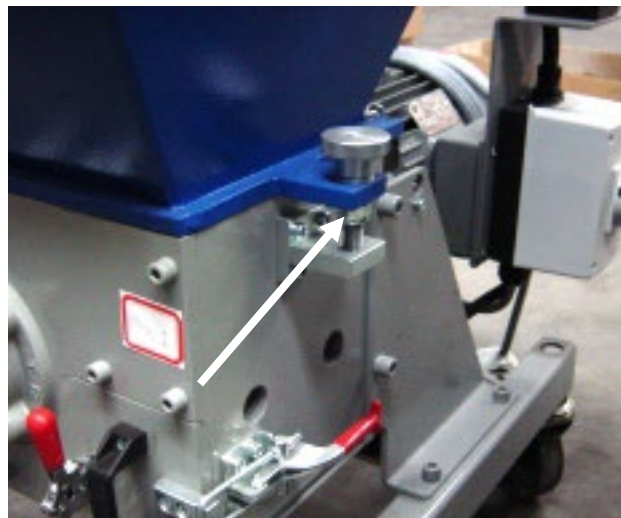
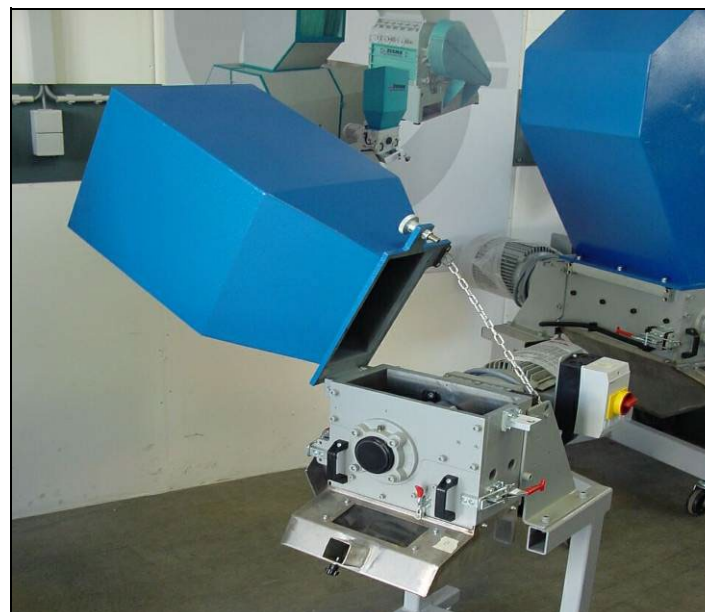

Illustration:  
Hopper (opened)





**ORIGINAL INSTRUCTION**  
**PART A: Basic machine**  
**Slow speed Granulator A18 Series**



---

**8.4.2 Closing the hopper**

**Proceed as follows:**



- ↓ Clean all surfaces between the hopper and the cutting chamber with a hand brush.
- ↓ Check that there are no objects in the grinding chamber.
- ↓ Close the hopper slowly to ensure that all parts fit properly.
- ↓ Tighten the threaded spindle.
- ↓ Machine can be started again.

**8.5 Cleaning the machine**

 <b>WARNING</b>	
	<b>Danger of cutting caused by sharp cutting knives, even when the rotor is at a standstill.</b> <b>Serious injury, particularly to hands and fingers, can result.</b> <b>Wear protective gloves.</b>

**Proceed as follows:**

- ↓ Open hopper (see *Opening the*).
- ↓ Remove the screen.
- ↓ Empty the screen.

 <b>WARNING</b>	
	<b>Inhalation of grinding dust which is dangerous to the health.</b> <b>This can result in injury to the respiratory tract.</b> <b>Never blow out the grinding material residue, use suction instead.</b> <b>Wear breathing protection if necessary.</b>

- ↓ Pre-clean the grinding chamber using a hand brush.
- ↓ Suck up the remaining grinding material residue using a suitable suction device.
- ↓ Remove clinging grinding material residue using a suitable wooden scraper.
- ↓ Put the screen into the screen support.
- ↓ Put the screen support into its working position
- ↓ Close the hopper
- ↓ Rotate in the threaded spindle
- ↓ Machine can be started again

## **8.6 Replacing the main bearing**

Due to the rotor stars are mounted directly on the drive shaft, the machine has only one flange bearing. The main bearing of the machine is dimensioned so that a bearing replacement is only necessary in exceptional cases. Dismounting and mounting of the bearing requires specialist knowledge and a careful working method. Therefore, in addition to the following advice, please observe the instructions given in the installation manual of the bearing manufacturer.

The bearing mounted in this machine is indicated in the spare parts list. A requirement for dismounting and mounting the bearings is a suitable pulling-off device.

### **8.6.1 Dismounting the main bearing**

**To dismount the bearings proceed as follows:**

The parts which are marked with a piece number are illustrated in the drawings of the spare parts list!

- ↓ Loosen the bearing mounting screws and take them out.
- ↓ Open the set screw on the bearing.
- ↓ Remove the bearing off the rotor axis using a pulling-off device.

**ORIGINAL INSTRUCTION**  
**PART A: Basic machine**  
**Slow speed Granulator A18 Series**

---

**8.6.2 Mounting the main bearing**

**To mount the bearings proceed as follows:**

- ↓ Before mounting, clean the bearing surfaces and the shaft surfaces thoroughly and grease lightly.
- ↓ Attach the bearing housing to the rotor axis.

**HINT**



- During mounting, the mounting forces must always engage into the inner ring, otherwise the roller bodies will be damaged.
- The hardened bearing rings are sensitive to impact stress. For this reason, never hit directly on the rings with the hammer, use instead preferably a brass arbour or better still a striking bush (piping piece) made from a soft material. The inner diameter of the striking bush should be only slightly larger than the diameter of the bearing base.
- The bearing is then pushed onto the shaft using light blows. When doing this, the force of pressure must be evenly distributed on the circumference of the bearing ring.

- ↓ Fix mounting screws
- ↓ Carry out a test run.

# ORIGINAL INSTRUCTION

## PART A: Basic machine

### Slow speed Granulator A18 Series

---

#### 8.6.3 Lubricating the main bearings

An important requirement for high operational safety and long service life of the arrangement of bearings is the correct lubricant supply. Every VIRTUS machine is greased and checked in test runs before delivery.



### HINT

**Unsuitable lubricant, lubricant deficiency, excessive lubrication or impurities in the lubricant lead to overheating and thus extreme wear of the bearings.**

#### 8.6.4 Lubrication intervals:

Relubrication of Y-bearing units is only required if

- are exposed to high humidity or severe contamination
- have to carry high loads
- have to run at high speeds or at temperatures above +55 °C for longer time

relubrication is required to enable the whole Y-bearing service life.

The relubrication interval  $t_r$  can be estimated from the diagram 1 as a function of the rotational speed  $n$  (r/min), the mean diameter of the bearing  $d_m$  (table) and the operating temperature (°C). The recommended intervals correspond to a time when 90% of the bearings are still reliably lubricated, and represent  $L_{10}$  grease life. When the  $L_{10}$  grease life is equivalent to or higher than the  $L_{10}$  basic rating life of the Y-bearing or Y-bearing unit, bearing or unit can be considered as being lubricated for life and relubrication is not required.

The intervals obtained from the diagram 2 are valid for Y-bearings and Y-bearing unit

- on horizontal shafts
- in stationary machines
- for operating temperatures between +40 and +55 °C
- at low loads ( $C/P \geq 15$ ).

# ORIGINAL INSTRUCTION

## PART A: Basic machine

### Slow speed Granulator A18 Series

Illustration:  
Diagram 1

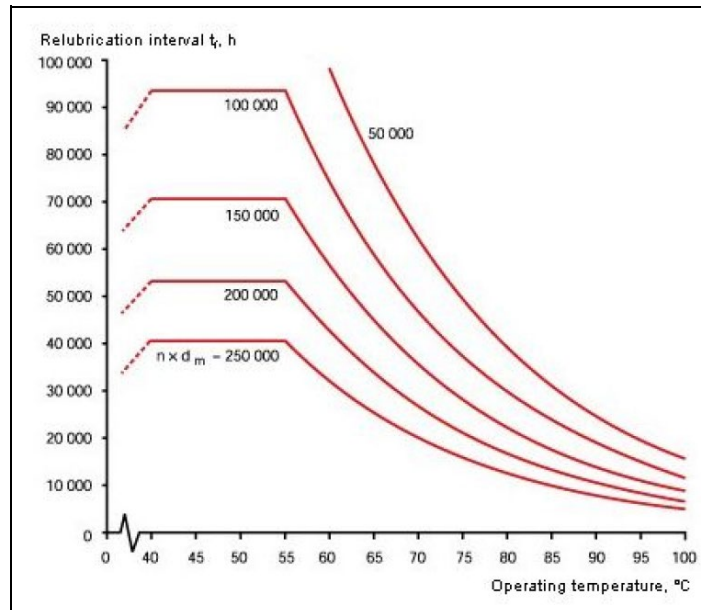

Vibrations have an influence on the grease life too. The extent cannot be quantified exactly but it is noticeable at rising operating temperatures. Also when the operating temperatures are below +40 °C for longer periods, the grease life is shortened because the oil separation is reduced.

The values for reducing the relubrication intervals are estimated values.

In cases where machines and equipment are used for a limited period of time, it is recommended that they should be relubricated at the end of the operational period, i.e. immediately before being laid up.

#### 8.6.5 Check lubricant quality

You can judge whether the lubricant needs to be replaced by checking for the following features:

- change in consistency,
- discolouration,
- degree of soiling.

#### 8.6.6 Replacing or refilling lubricant

### HINT



When relubricating, the grease should be pressed in slowly to the running bearing until fresh grease escapes from the seal. Avoid excessive pressure as this can damage the seals.

To find out which lubricants from which manufacturers you can use, look in the List of lubricants.

**ORIGINAL INSTRUCTION**  
**PART A: Basic machine**  
**Slow speed Granulator A18 Series**

---

**Refilling lubricant**

For relubrication of standard Y-bearing units the use of SKF grease LGWA 2, which is fully compatible with the original grease, is recommended. The multipurpose SKF greases LGMT 2 and LGMT 3 are also compatible with the original grease and may also be used for relubrication.

Illustration:  
Grease nipple



**ORIGINAL INSTRUCTION**  
**PART A: Basic machine**  
**Slow speed Granulator A18 Series**

---

**8.6.7 List of lubricants**

<b>Country of manufacture / manufacturer</b>	<b>Roller bearing grease</b>
ARAL	ARAL Grease HL 3
BP	BP ENERGREASE LS 3
CASTROL	CASTROL SPHEEROL AP 3
ESSO	Beacon 3
FUCHS	FUCHS Grease 1200 FUCHS Grease FWA 220
SHELL	SHELL Alvania Grease 3
MOBIL-OIL	MOBILUX 3
WISURA	WISURA Liba L 3
Zeller & Gmelin	ZET GE Grease M 50
FAG	FAG L 71
ANTAR Petroles de l'Atlantique	ROLEXA
Holland, Beverol	Beverol Multi Purpose Grease
Italy, Agip	AGIP Grease 33 FD
Swede, NYNÄS	Nynäs FI 3-42

# ORIGINAL INSTRUCTION

## PART A: Basic machine

### Slow speed Granulator A18 Series

---

#### 8.7 Replacing the screen

In order to keep the throughput of the granulator and the quality of the grinding material constant, the condition of the screen must be checked regularly.

The screen may be damaged, dirty or not suitable for the grinding material:

- Screen holes too fine: overheating of the grinding material.
- Screen holes too course: parts in ground material which are too big.

#### **Proceed as follows:**

- ↓ Switch off the granulator at the main switch, safeguard main switch using a padlock.
- ↓ Open the closing lever at the suction trough
- ↓ Take out the suction trough
- ↓ Unfasten the screen support mounting clamps
- ↓ Take out the screen support
- ↓ Remove the screen.
- ↓ Put new screen into the screen support.
- ↓ Put the screen support into the working position and fasten using the mounting clamps.
- ↓ Fix the suction trough.
- ↓ Granulator can be started again

Illustration:  
(1) Screen support

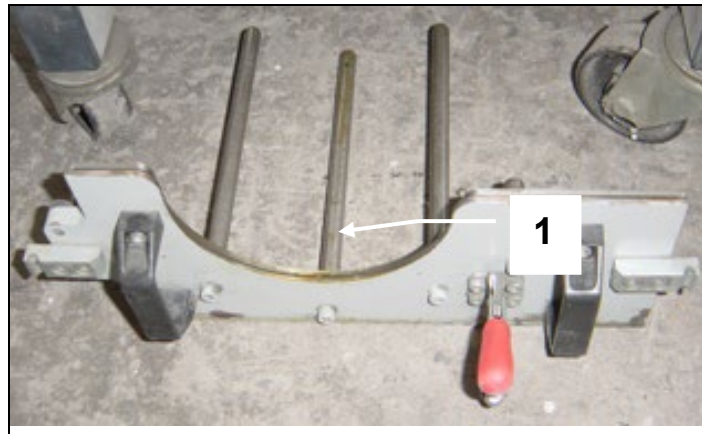



**ORIGINAL INSTRUCTION**  
**PART A: Basic machine**  
**Slow speed Granulator A18 Series**

---

Illustration:  
(2) Screen

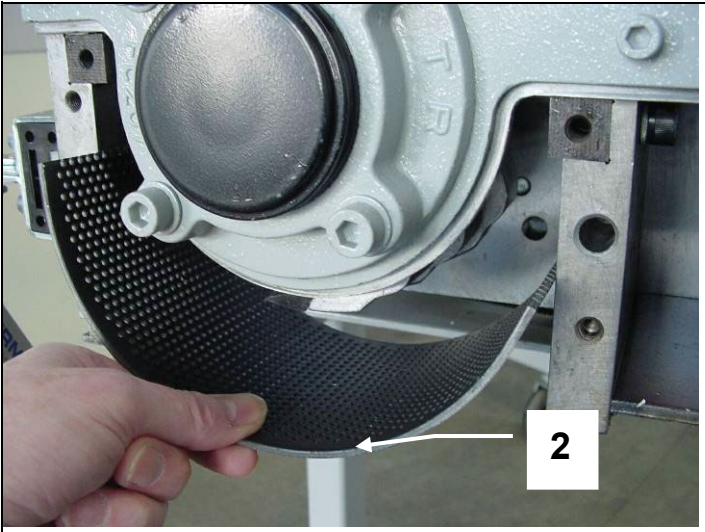

**ORIGINAL INSTRUCTION**  
**PART A: Basic machine**  
**Slow speed Granulator A18 Series**

---

**8.8 Working on the cutting knives**

In the case of granulators, the correct grinding properties, correct setting and mounting of the cutting knives are important factors to ensure perfect functioning and economic operation of the machine.

**8.8.1 Replacing and checking the cutting knife mountings**

Due to their function, certain machine parts are subject to stress in their operating state as a result of vibrations, which can lead to loosening of the screw connections. Therefore, it is absolutely necessary to check the cutting knife mounting screws in accordance with the *Maintenance plan*.

- ↓ Tighten the mounting screws on the cutting knives using a torque wrench which is set to the required torque for the screw size.  
**The required torque for the knife fixing bolts is 41 Nm.**

You can find out the required torque from the following table. Take note too that the tightening capacity decreases of screws which have been loosened and tightened again several times. New screws of the same material quality must therefore replace the cutting knife mounting screws after they have been loosened and tightened several times.

**Torque:**



Bolt type	Grade 8.8		Grade 10.9		Grade 12.9	
	Nm	lbf ft	Nm	lbf ft	Nm	lbf ft
M8	25	18.4	35	25.8	41	30.2
M10	49	36.1	69	50.9	83	61.2
M12	86	63.4	120	88.5	145	106
M16	210	154	295	217	355	261



**ORIGINAL INSTRUCTION**  
**PART A: Basic machine**  
**Slow speed Granulator A18 Series**

---

**8.8.2 Checking the condition of the cutting knives**

 <b>WARNING</b>	
	<p><b>Danger of cutting caused by sharp knives, even when the rotor is at a standstill.</b> <b>Serious injury, particularly to hands and fingers, can result.</b> <b>Wear protective gloves.</b></p>

The cutting knives become blunt after a certain number of operation hours. Therefore they should be checked regularly.

**Using blunt knives has the following consequences:**

- Decreased grinding capacity.
- Increased current consumption of the drive motor.
- Inexact cut.
- Overheating of the ground material.

Rotor knives:

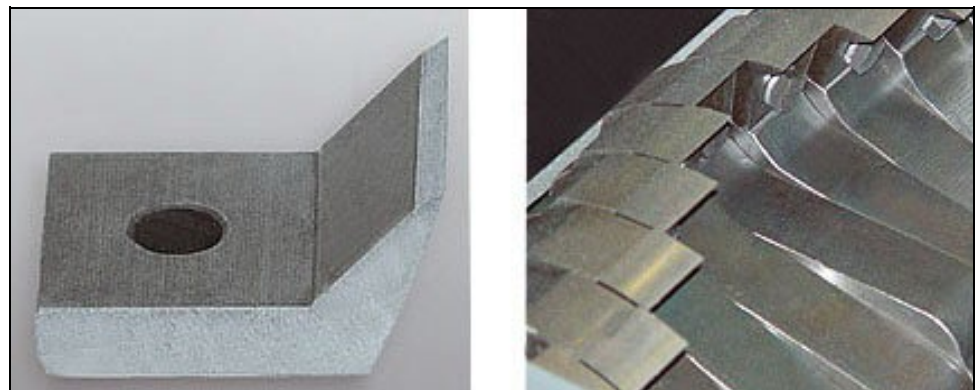

**ORIGINAL INSTRUCTION**  
**PART A: Basic machine**  
**Slow speed Granulator A18 Series**

**8.8.3 Dismounting the cutting knives**

<b>! WARNING</b>	
	<b>Danger of cutting caused by sharp knives, even when the rotor is at a standstill. Serious injury, particularly to hands and fingers, can result. Wear protective gloves.</b>

**Proceed as follows:**

Illustration:

- (1) Rotor knife
- (2) Knife mounting screws

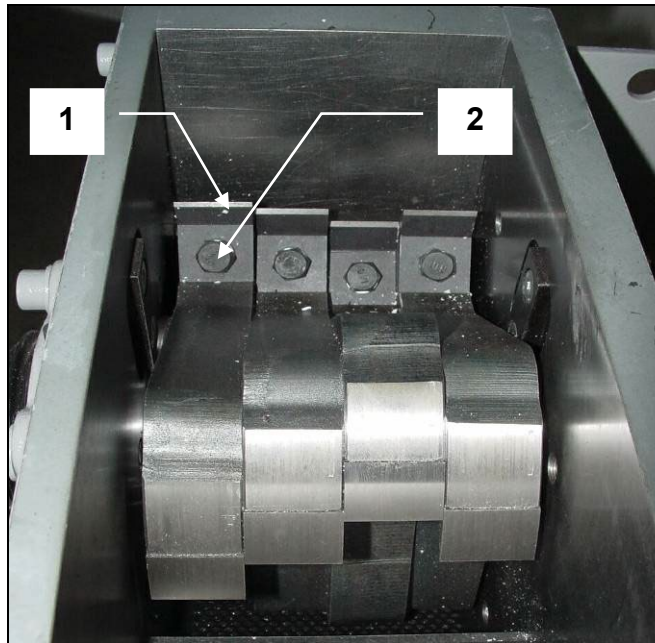

- ↓ Open the hopper (see *Opening the hopper*).
- ↓ Remove suction trough and screen holder.
- ↓ Safeguard the rotor against torsion.
- ↓ Loosen the stator knife mounting screws.
- ↓ Take out the knife mounting screws
- ↓ Put to eye bolt screw into the thread on the end of the stator knives.
- ↓ Take out stator knives
- ↓ Loosen the rotor knife mounting screws.
- ↓ Take out the knife mounting screws and rotor knives.

**ORIGINAL INSTRUCTION**  
**PART A: Basic machine**  
**Slow speed Granulator A18 Series**

---



Illustration:

- (1) Stator knife
- (2) Screw for take out stator knife



**ORIGINAL INSTRUCTION**  
**PART A: Basic machine**  
**Slow speed Granulator A18 Series**

**8.8.4 Mounting the cutting knives**

 <b>WARNING</b>	
	<p><b>Danger of cutting caused by sharp knives, even when the rotor is at a standstill.</b> <b>Serious injury, particularly to hands and fingers, can result.</b> <b>Wear protective gloves.</b></p>

## HINT



The cutting knives, in particular the rotor knives, should only be sharpened or replaced in sets. There is a danger of balance error if a combination of rotor knives from different knife sets is used.

### Proceed as follows:

- ↓ Clean the knife supporting surface and threaded holes.
- ↓ Insert sharp knives and push against the setting surface.
- ↓ Screw in the mounting screws DIN933/M8x20/12.9 and tighten using torque wrench.

**The required torque for all rotor knife mounting bolts is 41 Nm** (also see the table under *Replacing and checking the cutting knife mountings*).

- ↓ Insert stator knives
- ↓ Screw in the mounting screws DIN912/M10x30/12.9 and tighten using torque wrench.

**The required torque for all stator knife mounting bolts is 83 Nm** (also see the table under *Replacing and checking the cutting knife mountings*).

- ↓ **Check whether the cutting gap is correct and whether the cutting knives do not collide as you turn the rotor by hand.**

## TIP



Stator knives from VIRTUS have four symmetrical cutting edges.

**This makes it possible to turn the knives and only to sharpen after every fourth knife change.**

- ↓ Remove tools and other objects from the grinding chamber.
- ↓ Close the hopper .
- ↓ Fix screen, screen holder and suction trough
- ↓ Switch on the granulator for a short time without grinding material and listen for noises. If you hear unusual noises, determine the cause and eliminate it.

**ORIGINAL INSTRUCTION**  
**PART A: Basic machine**  
**Slow speed Granulator A18 Series**

---

**8.8.5 Sharpening cutting knives**



**TIP**

Specialist sharpening of the cutting knives is part of the service offer of VIRTUS .

 **WARNING**



**Danger of cutting caused by sharp knives, even when the rotor is at a standstill.**  
**Serious injury, particularly to hands and fingers, can result.**  
**Wear protective gloves.**



**HINT**

The cutting knives, in particular the rotor knives, should only be sharpened or replaced in sets. There is a danger of balance error if a combination of rotor knives from different knife sets is used.

**Proceed as follows:**

- ↓ Dismount the cutting knives (see *Dismounting the cutting knives*).
- ↓ Sharpen the cutting knives.  
A specialist in accordance with the sharpening plan using particular care should uniformly sharpen the cutting knives mechanically. It is important to make sure that sharpening takes place with small grinding allowance and sufficient coolant supply. The sharpening process is finished when the cutting edge is sharply cut. Not all indentations must be ground out, otherwise the number of possibilities for sharpening is unnecessarily reduced. For the sharpening process, use soft grinding wheels (Quality 40 H or 46 K). Knives, which have grinding cracks, are not to be reused due to danger of breakage during operation.
- ↓ Whet the cutting edges of the cutting knives using a whetstone.  
By taking these measures, the service life of the cutting knives can be increased.
- ↓ Set the cutting knives (see *mounting the cutting knives*).
- ↓ Mount the cutting knives (see *mounting the cutting knives*).

**ORIGINAL INSTRUCTION**  
**PART A: Basic machine**  
**Slow speed Granulator A18 Series**

Illustration: *Resharpener plan rotor knife*

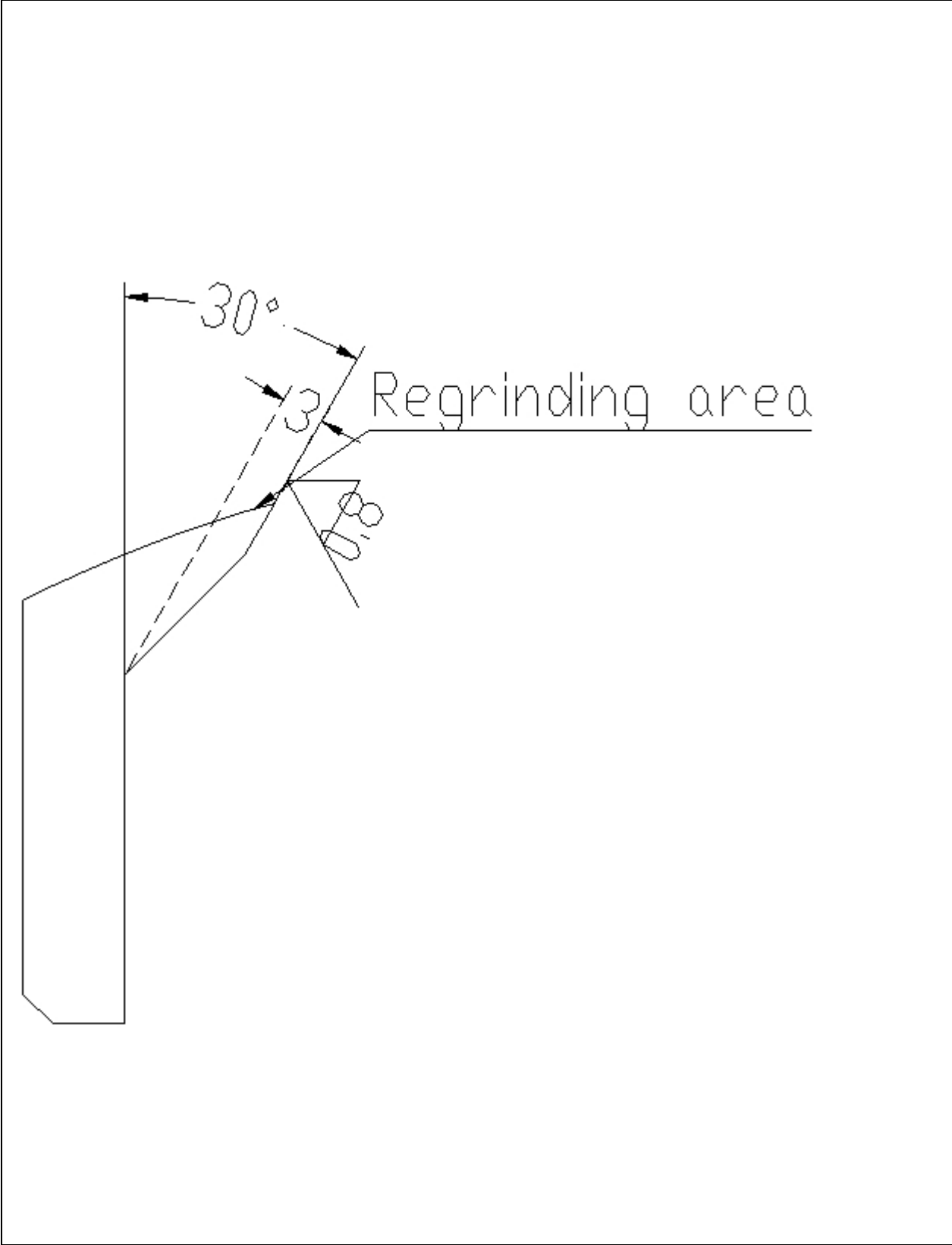







**ORIGINAL INSTRUCTION**  
**PART A: Basic machine**  
**Slow speed Granulator A18 Series**

---

**8.8.6 Transporting and storing the cutting knives**

 <b>WARNING</b>	
	<p><b>Danger of cutting caused by sharp cutting knives. Serious injury, in particular to hands and fingers, can result. Only transport and store the cutting knives packaged. Grease the cutting knives well, so that they do not rust. Protect the cutting edges with doubled cardboard and use adhesive tape to safeguard the knives against slipping out of the sides of the sheath.</b></p> <p><b>After unpacking, you must degrease the cutting knives so that they can be gripped safely.</b></p>

**ORIGINAL INSTRUCTION**  
**PART A: Basic machine**  
**Slow speed Granulator A18 Series**

---

## **9 TROUBLESHOOTING**

### **9.1 Machine blocks or switches itself off**

<b>No.</b>	<b>Possible causes</b>	<b>Remedy required</b>
9.1.1	Too much feed material.	Reduce grinding material in feed.
9.1.2	Screen blocked.	Clean screen, check condition, if necessary select larger screen perforation.
9.1.3	Knife condition.	Check knives and sharpen or replace if needed.
9.1.4	Cutting gap.	Check cutting gap and set according to the instructions in this operation manual.
9.1.5	Suction trough blocked.	Empty suction trough
9.1.6	Current failure.	Check limit switch for defective contact. Check electrical connection, if necessary tighten limit switch.
9.1.7	Rotational direction of rotor.	Check motor and reverse polarity if necessary.

### **9.2 Rotor does not grip bulky material**

<b>No.</b>	<b>Possible causes</b>	<b>Remedy required</b>
9.2.1	Knife condition.	Check and sharpen if needed according to the instructions in this operation manual.
9.2.2	Protruding bed knife.	Chamfer bed knives; consult with service department of VIRTUS .

### **9.3 Overheating of the grinding material**

<b>No.</b>	<b>Possible causes</b>	<b>Remedy required</b>
9.3.1	Screen perforation too small.	Insert a screen with larger perforation.
9.3.2	Knives blunt.	<b>Resharpen knives.</b>

### **9.4 Unusual vibrations**

<b>No.</b>	<b>Possible causes</b>	<b>Remedy required</b>
9.4.1	Rotor out of balance.	Weigh knives, balance rotor.
9.4.2	Bearing damage.	Check bearings, replace bearings if necessary.
9.4.3	Machine feet defective (wheels).	Check wheels and renew these if necessary.

### **9.5 Extreme cutter wear**

<b>No.</b>	<b>Possible causes</b>	<b>Remedy required</b>
9.5.1	Bearing damage.	Check bearings, replace bearings if necessary.
9.5.2	Knife finish.	Check knife and sharpen or replace if necessary.
9.5.3	Wrong cutting angle.	Check cutting gap and set according to the instructions in this operation manual.
9.5.4	Foreign matter.	Fit feed device with a metal detector.

### **9.6 Bearings too hot**

<b>No.</b>	<b>Possible causes</b>	<b>Remedy required</b>
9.6.1	Too much grease in bearing.	Reduce amount of grease.
9.6.2	Rubbing on housing sealing ring.	Check sealing ring, oil or replace.
9.6.3	Bearing damage.	Check bearings, replace if necessary.
9.6.4	No grease in bearing.	Lubricate bearing.



**ORIGINAL INSTRUCTION**  
**PART A: Basic machine**  
**Slow speed Granulator A18 Series**

**9.7 Too many fines in grinding material**

No.	Possible causes	Remedy required
9.7.1	Type of material.	Fit fines separator.
9.7.2	Screen worn.	Renew screen, possibly using manganese steel.
9.7.3	Unsuitable screen perforation.	Replace screen after consulting VIRTUS service department.

**9.8 Cutting gap alters during operation**

No.	Possible causes	Remedy required
9.8.1	Knife mounting screws not tight.	Retighten using torque wrench in accordance with table in operation manual.
9.8.2	Screw fatigue.	Fit new screws.
9.8.3	Supporting surfaces not clean.	Clean and de-rust supporting surfaces.
9.8.4	Threads in housing worn.	Fit new bushes in housing.

**9.9 Screen damage**

No.	Possible causes	Remedy required
9.9.1	Screen inserted wrongly.	Fit screen correctly.
9.9.2	Screen support buckled.	Replace screen support.

**9.10 Granulator does not start**

No.	Possible causes	Remedy required
9.10.1	Limit switches not activated.	Check position of limit switch and correct.
9.10.2	Main and control fuses.	Replace fuse.
9.10.3	Residue material in granulator.	Empty granulator before switching on.
9.10.5	Star delta connection.	Correct wiring on motor.

**9.11 Granulator blocks when under load**

No.	Possible causes	Remedy required
9.11.1	Feed too much.	Feed slowly.
9.11.2	Limit switch loose or wrongly set.	Reposition and tighten limit switch.
9.11.3	Fuse defective.	Replace fuse. Fit larger fuse. <b>Only after consulting the service department of VIRTUS.</b>
9.11.4	Motor fuse switches off - red indicator.	Reduce feed quantity of the grinding material, correct setting, replace fuse.

**ORIGINAL INSTRUCTION**  
**PART A: Basic machine**  
**Slow speed Granulator A18 Series**

---

**10 STORAGE, DISPOSAL, TRANSPORTATION**

**10.1 Storage**



Clean the machine (see *Cleaning the machine*). Preserve all polished metal surfaces using a suitable rust preventing agent. Store the machine in an enclosed, dry place. Cover the machine completely with a plastic sheet.

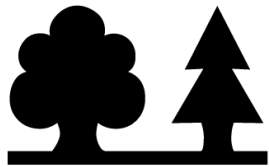

**10.2 Disposal**



**Protect the environment.**

The disposal of machines, machine components and process materials is partially subject to legal controls. More detailed information is given at the relevant administrative authority (e.g. regional and national Water Conservation Bureaux and Environmental Protection Agencies). Only deposit the material to be disposed of at authorized drop-off points.

**10.3 Transportation**

 <b>WARNING</b>	
	<p><b>Suspended load.</b> <b>Falling loads can cause serious injury or death.</b> <b>Only use a crane or forklift truck, which is suitable for the weight and dimensions of the loads.</b></p>
	<p><b>Also use suitable stopping means and pay attention to the gravity centre location.</b> <b>Do not step under the suspended load.</b> <b>Wear a protective helmet in addition to your basic protective gear.</b></p>

## **11 CUSTOMER SERVICE AND SPARE PARTS ORDERS**



Should problems occur during operation of the machine or if you have general questions about the machine which this operation manual cannot answer, please do not hesitate to contact us. We would be pleased to help you further in order to solve your problem as quickly as possible.

You can identify the spare parts you require using the spare parts list. Please quote the following information when making your order so that we can deliver the spare parts to you quickly:

- Company name and address.
- Contact person.
- Machine type.
- Machine number.
- Piece number of the spare part.
- Spare part reference.
- Subject number.
- Order quantity.

Virtus Equipment  
9120 Centerlinks Commerce DR., Unit 4  
Fort Myers, FL 33912

Phone: +1-239-219-1500  
Parts@Virtus-Equipment.com

[www.Virtus-Equipment.com](http://www.Virtus-Equipment.com)

---



### **TIP**

**The easiest way to order your spare parts is to copy the spare parts list and to fill in the order amount after the respective spare part.**

**ORIGINAL INSTRUCTION**  
**PART A: Basic machine**  
**Slow speed Granulator A18 Series**

**12 SPARE PARTS LIST A18/12**

Pos.	Pc	Description/Standard	Partnumber/SAP	Order
100		<b>Machine complete</b>	10000000	
101	1	#1 Standard hopper	20450000	
		#3 T-hopper	20452500	
		#4 UK		
102	1	Cutting chamber	20460000	
102.1	1	Cutting chamber Part 1 - drive side		
102.2	1	Cutting chamber Part 2 - bearing side		
102.3	1	Cutting chamber Part 3 - front side		
102.4	1	Cutting chamber Part 4 - back side		
103	1	Suction #1 low frame		
		Suction #2 high frame		
104	1	Clamp PC-213U	80003290	
105	2	Clamp PC-431	80003300	
106	2	Scraper	80012570	
107	4	Bolts for scraper DIN7991 M6x12 8.8	80011610	
108	2	Wheel Ø80 no brake	80003990	
109	2	Wheel Ø80 with brake	80003980	
110	1	Low Frame	20463000	
		High Frame	20463500	
111	2	Handle	80013120	
112	1	Hopper locking screw	20482100	
113	1	Frame for PE BOX(High Frame)	20463400	
114	1	PE Box(High Frame)	80012890	
200		<b>Screen</b>		
201	3	Long screen support bar	20461000	
202	2	Short screen support bar	20461100	
203	1	Screen Ø 6	20481000	
204	1	Front plate		
300		<b>Bearing</b>		
301	1	Bearing housing complete SBFC207	80003160	
400		<b>Drive</b>		
401	1	Motor 2.2KW 380V50HZ	80020035	
500	1	<b>Rotor assembly</b>	20460720	
501	1	Round nut GB810 M45×1.5	80012960	
502	1	Clamping Washer GB858 φ45	80012980	
503	1	Front sleeve GSL1812-02-02-01	20460400	
504	1	Back sleeve GSL1812-02-02-02	20460500	
505	1	Key DIN6885-1	20460600	



**ORIGINAL INSTRUCTION**  
**PART A: Basic machine**  
**Slow speed Granulator A18 Series**

---

506	12	Rotor Knife	80001030	
507	12	Bolt DIN933 M8×20 12.9	80009610	
508	12	Washer DIN127-8	80010840	
600	2	<b>Stator knife</b>	80001290	
601	4	Bolt DIN912 M10×30 12.9	80011150	
700		<b>Electrical parts</b>		
701	3	Safety switch AZ15zvrk-1476-1	80005560	
702	1	Control panel	10002000	





**ORIGINAL INSTRUCTION**  
**PART A: Basic machine**  
**Slow speed Granulator A18 Series**

**13 SPARE PARTS LIST A18/18**

Pos.	Pc	Description/Standard	Partnumber/SAP	Order
100		<b>Machine complete</b>	10000010	
101	1	#1 Standard hopper	20500000	
		#3 Thai-hopper	20502500	
		#4 UK		
102	1	Cutting chamber	20510000	
102.1	1	Cutting chamber Part 1 - drive side		
102.2	1	Cutting chamber Part 2 - bearing side		
102.3	1	Cutting chamber Part 3 - front side		
102.4	1	Cutting chamber Part 4 - back side		
103	1	Suction #1 low frame		
		Suction #2 high frame		
104	1	Clamp PC-213U	80003290	
105	2	Clamp PC-431	80003300	
106	2	Scraper	80012570	
107	4	Bolts for scraper DIN7991 M6x12 8.8	80011610	
108	2	Wheel Ø80 no brake	80003990	
109	2	Wheel Ø80 with brake	80003980	
110	1	Low Frame	20463000	
		High Frame	20463500	
111	2	Handle	80013120	
112	1	Hopper locking screw	20482100	
113	1	Frame for PE BOX(High Frame)	20463400	
114	1	PE Box(High Frame)	80012890	
200		<b>Screen</b>		
201	3	Long screen support spindle	20510500	
202	2	Short screen support spindle	20461100	
203	1	Screen Ø 6	20520300	
204	1	Front plate		
300		<b>Bearing</b>		
301	1	Bearing housing complete SBFC207	80003160	

**ORIGINAL INSTRUCTION**  
**PART A: Basic machine**  
**Slow speed Granulator A18 Series**

---

400		<b>Drive</b>		
401	1	Gearbox Motor 3KW /400V/50HZ SEW	80000540	
		Gearbox Motor 3KW /400V/50HZ Nord	80020406	
500	1	<b>Rotor assemble</b>	20510800	
501	1	Round nut GB810 M45×1.5	80012960	
502	1	Clamping Washer GB858 φ45	80012980	
503	1	Front sleeve GSL1812-02-02-01	20510200	
504	1	Back sleeve GSL1812-02-02-02	20510300	
505	1	Key DIN6885-1	20510400	
506	18	Rotor Knife	80001030	
507	18	Bolt DIN933 M8×20 12.9	80009610	
508	18	Washer DIN127-8	80010840	
600	2	<b>Stator knife</b>	80001270	
601	4	Bolt DIN912 M10×30 12.9	80011150	
700		<b>Electrical parts</b>		
701	3	Safety switch AZ15zvrk-1476-1	80005560	
702	1	Control panel	10002010	

**ORIGINAL INSTRUCTION**  
**PART A: Basic machine**  
**Slow speed Granulator A18 Series**

**14 SPARE PARTS LIST A18/30**

Pos.	Pc	Description/Standard	Partnumber/SAP	Order
100		<b>Machine complete</b>	10000020	
101	1	#1 Standard hopper	20550000	
		#3 Thai-hopper	20552500	
		#4 UK		
102	1	Cutting chamber	20560000	
102.1	1	Cutting chamber Part 1 - drive side		
102.2	1	Cutting chamber Part 2 - bearing side		
102.3	1	Cutting chamber Part 3 - front side		
102.4	1	Cutting chamber Part 4 - back side		
103	1	Suction #1 low frame		
		Suction #2 high frame		
104	1	Clamp PC-213U	80003290	
105	2	Clamp PC-431	80003300	
106	2	Scraper	80012570	
107	4	Bolts for scraper DIN7991 M6x12 8.8	80011610	
108	2	Wheel Ø80 no brake	80003990	
109	2	Wheel Ø80 with brake	80003980	
110	1	Low Frame	20463000	
		High Frame	20463500	
111	2	Handle	80013120	
112	1	Hopper locking screw	20482100	
113	1	Frame for PE BOX(High Frame)	20463400	
114	1	PE Box(High Frame)	80012890	
200		<b>Screen</b>		
201	3	Long screen support spindle	20560400	
202	2	Short screen support spindle	20461100	
203	1	Screen Ø 6	20580300	
204	1	Front plate		
300		<b>Bearing</b>		
301	1	Bearing housing complete SBFC207	80003160	

**ORIGINAL INSTRUCTION**  
**PART A: Basic machine**  
**Slow speed Granulator A18 Series**

---

400		<b>Drive</b>		
401	1	Gearbox Motor 4KW /400V/50HZ SEW	80000560	
		Gearbox Motor 4KW /400V/50HZ Nord	80020280	
500	1	<b>Rotor assemble</b>	20550800	
501	1	Round nut GB810 M45×1.5	80012960	
502	1	Clamping Washer GB858 φ45	80012980	
503	1	Front sleeve GSL1818-02-02-01	20510200	
504	1	Back sleeve GSL1818-02-02-02	20510300	
505	1	Key	20560300	
506	30	Rotor Knife	80001030	
507	30	Bolt DIN933 M8×20 12.9	80009610	
508	30	Washer DIN127 8	80010840	
600	2	<b>Stator knife</b>	80001250	
601	6	Bolt DIN912 M10×30 12.9	80011150	
700		<b>Electrical parts</b>		
701	3	Safety switch AZ15zvrk-1476-1	80005560	
702	1	Control panel	10002020	

**ORIGINAL INSTRUCTION**  
**PART A: Basic machine**  
**Slow speed Granulator A18 Series**

**15 SPARE PARTS LIST A18/43**

Pos.	Pc	Description/Standard	Partnumber/SAP	Order
100		<b>Machine complete</b>	10000030	
101	1	#1 Standard hopper	20600000	
		#3 Thai-hopper	20602000	
		#4 UK		
		#5 AMIS		
102	1	Cutting chamber	20610000	
102.1	1	Cutting chamber Part 1 - drive side		
102.2	1	Cutting chamber Part 2 - bearing side		
102.3	1	Cutting chamber Part 3 - front side		
102.4	1	Cutting chamber Part 4 - back side		
103	1	Suction #1 low frame		
		Suction #2 high frame		
104	1	Clamp PC-213U	80003290	
105	2	Clamp PC-431	80003300	
106	2	Scraper	80012570	
107	4	Bolts for scraper DIN7991 M6x12 8.8	80011610	
108	2	Wheel Ø80 no brake	80003990	
109	2	Wheel Ø80 with brake	80003980	
110	1	Low Frame	20613000	
		High Frame	20613500	
111	2	Handle	80013120	
112	1	Hopper locking screw	20482100	
113	1	Frame for PE BOX(High Frame)	20463400	
114	1	PE Box(High Frame)	80012890	
200		<b>Screen</b>		
201	3	Long screen support spindle	20610550	
202	2	Short screen support spindle	20461100	
203	1	Screen Ø 6	20630300	
204	1	Front plate		
300		<b>Bearing</b>		
301	1	Bearing housing complete SBFC207	80003160	
400		<b>Drive</b>		
401	1	Motor 4KW 380V50HZ	80000600	
500	1	<b>Rotor assembly</b>	20611100	
501	1	Round nut GB810 M45×1.5	80012960	
502	1	Clamping Washer GB858 φ45	80012980	
503	1	Front sleeve GSL1818-02-02-01	20510200	
504	1	Back sleeve GSL1818-02-02-02	20510300	



**ORIGINAL INSTRUCTION**  
**PART A: Basic machine**  
**Slow speed Granulator A18 Series**

---

505	1	Key	20610500	
506	45	Rotor Knife	80001030	
507	45	Bolt DIN933 M8×20 12.9	80009610	
508	45	Washer DIN127 8	80010840	
600	2	<b>Stator knife</b>	80001230	
601	8	Bolt DIN912 M10×30 12.9	80011150	
700		<b>Electrical parts</b>		
701	3	Safety switch AZ15zvrk-1476-1	80005560	
702	1	Control panel	10002030	

**ORIGINAL INSTRUCTION**  
**PART A: Basic machine**  
**Slow speed Granulator A18 Series**

Illustration: Machine complete

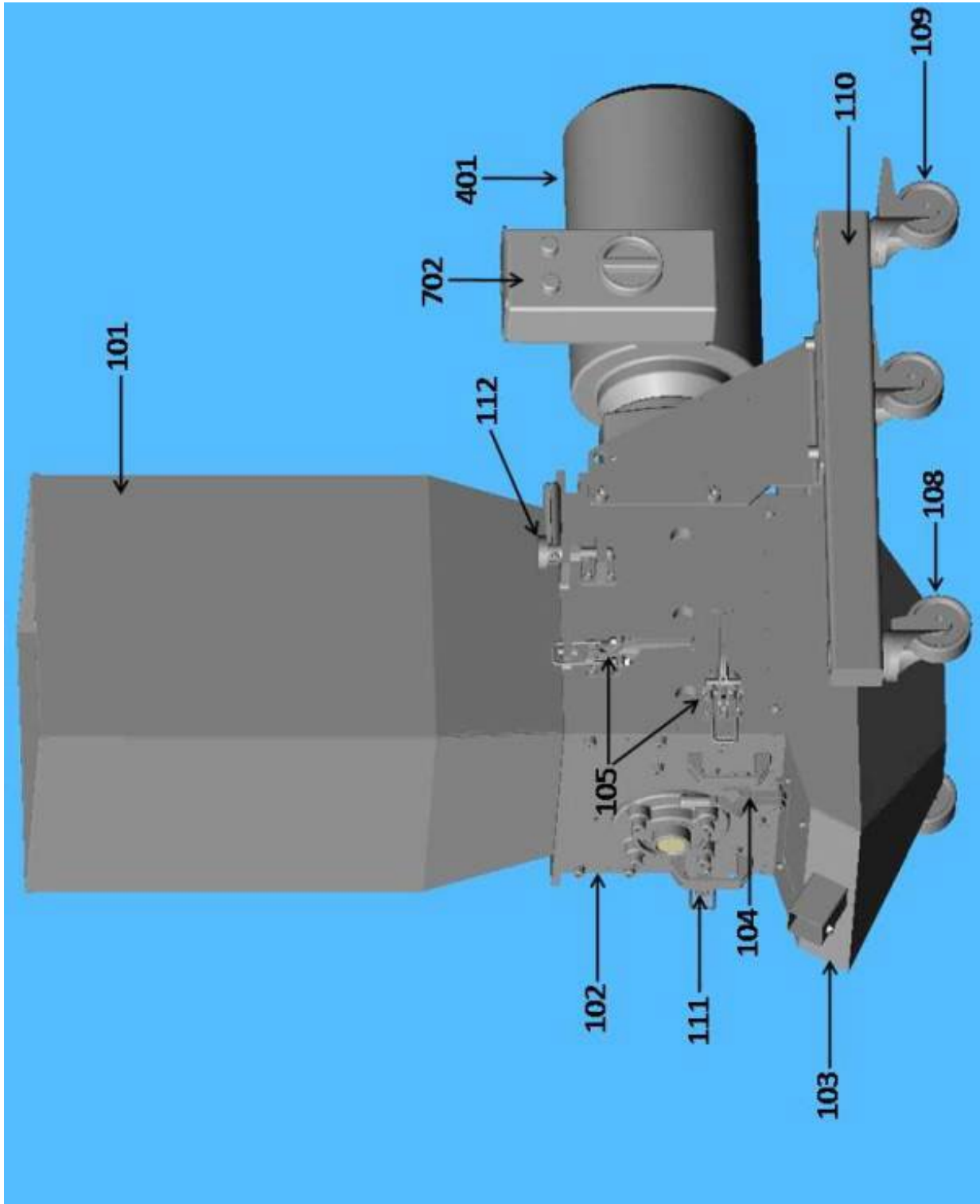

**ORIGINAL INSTRUCTION**  
**PART A: Basic machine**  
**Slow speed Granulator A18 Series**

Illustration: cutting chamber assembly

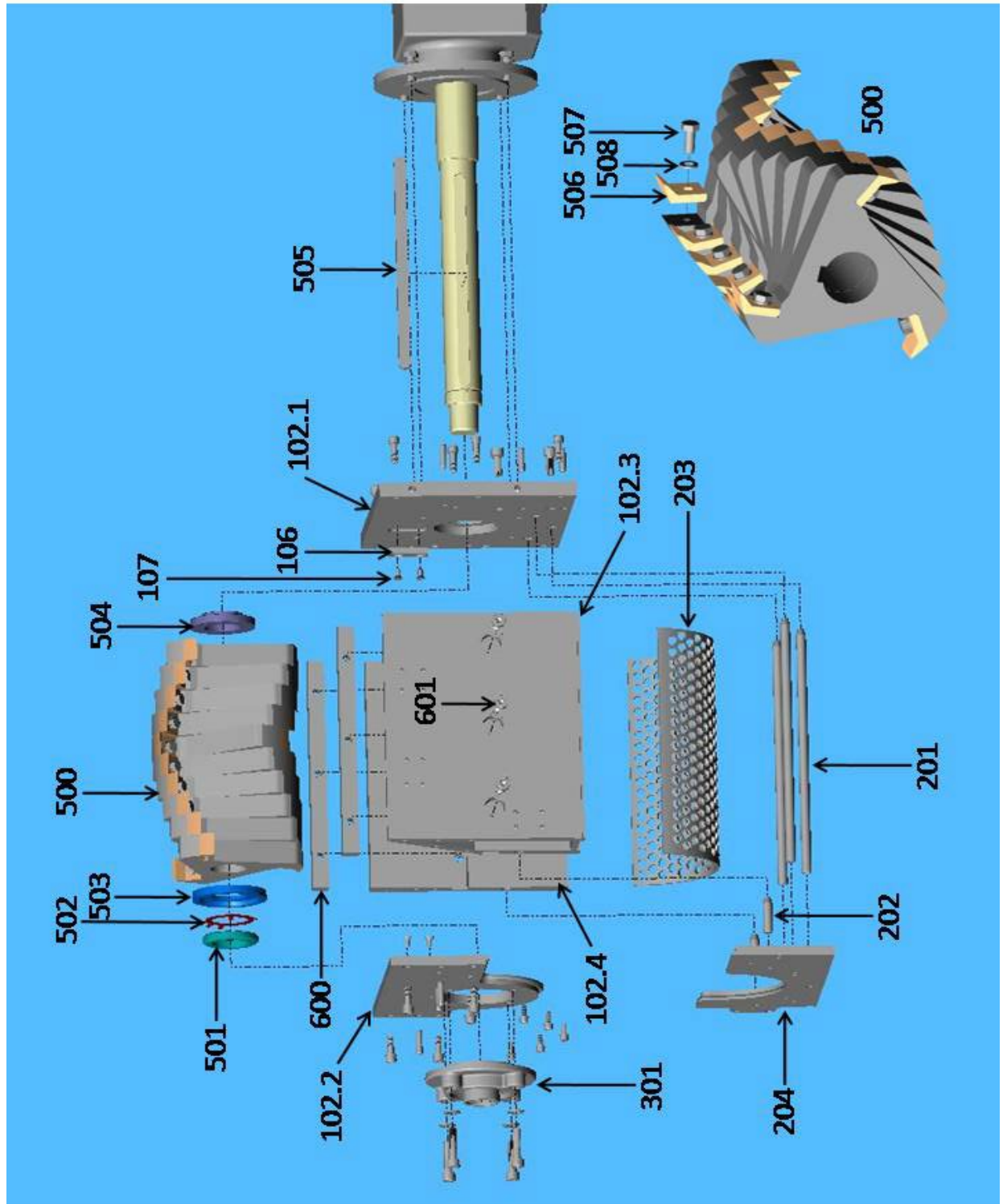



**16 CLARIFICATION FOR PERSONAL TRAINING**

This is to certify that I have attended an in company training for service and operation of the granulator and understand all safety regulations. Further to this I have read and understand the owners' manual.

<b>City</b>	<b>Date</b>	<b>Printed name</b>	<b>Signature</b>

**ORIGINAL INSTRUCTION**  
**PART A: Basic machine**  
**Slow speed Granulator A18 Series**

**17 STANDARD MACHINE LAYOUTS**

**17.1 A18/12**

**17.1.1 Hopper Nr 1, Frame Nr 1, Suction bin Nr 1**

**Technical Data**  
 1. Motor: 2.2kw, Rotor speed: 150rpm.  
 2. Max. size of granulating: 180x120.

Name	GSL180/120 1-1-1			Customer Confirm	Date	Sheet	of	
Design	Customer	Sales	Date	First	Angle			
Appr.								
Rev.								

**ORIGINAL INSTRUCTION**  
**PART A: Basic machine**  
**Slow speed Granulator A18 Series**

**17.1.2 Hopper Nr 3, Frame Nr 1, Suction bin Nr 1**

**Technical Data**  
 1. Motor: 2.2kw, Rotor speed: 150rpm.  
 2. Max. size of granulating: 180x120.

Name	GSL180/120 3-1-1		Customer Confirm	Dwg No.	Sheet	of
Design	Customer		Date			
Appr.	Sales		First Angle			
Rev.	Date					

**ORIGINAL INSTRUCTION**  
**PART A: Basic machine**  
**Slow speed Granulator A18 Series**

**17.1.3 Hopper Nr 4, Frame Nr 1, Suction bin Nr 1**

**Technical Data**  
 1. Motor: 2.2kw, Rotor speed: 150rpm.  
 2. Max. size of granulating: 180x120.

Name	GSL180/120 4-1-1			Customer Confirm	Dwg No.	Sheet	of
Design	Customer			Date			
Appr.	Sales			First Angle			
Rev.	Date						

Zema Machinery & Recycling Technology (Shanghai) Co., Ltd.

**ORIGINAL INSTRUCTION**  
**PART A: Basic machine**  
**Slow speed Granulator A18 Series**

**17.1.4 Hopper Nr 1, Frame Nr 2, Suction bin Nr 2**

Control panel with E-Stop

345  
250  
r150

1514  
904  
345  
Ø215  
420

(836)

**Technical Data**  
 1. Motor: 2.2kw, Rotor speed: 150rpm.  
 2. Max. size of granulating: 180x120.

Name	GSL180/120 1-2-2			Customer Confirm	_____	Dwg No.	_____	Sheet	_____	of	_____
Design	Customer	_____	_____	Date	_____						
Appr.	Sales	_____	_____	First Angle							
Rev.	Date	_____	_____								

Zema Machinery(Shanghai)Co.,Ltd.

**ORIGINAL INSTRUCTION**  
**PART A: Basic machine**  
**Slow speed Granulator A18 Series**

**17.1.5 Hopper Nr 3, Frame Nr 2, Suction bin Nr 2**

**Technical Data**  
 1. Motor: 2.2kw, Rotor speed: 150rpm.  
 2. Max. size of granulating: 180x120.

Name	GSL180/120 3-2-2			Customer Confirm	Date	Sheet	of
Design	Customer	Sales	Date			Zerma Machinery & Recycling Technology (Shanghai) Co., Ltd.	
Appr.				First Angle			
Rev.							

**ORIGINAL INSTRUCTION**  
**PART A: Basic machine**  
**Slow speed Granulator A18 Series**

**17.1.6 Hopper Nr 4, Frame Nr 2, Suction bin Nr 2**

**Control panel with E-Stop**

**Technical Data**  
 1. Motor: 2.2kw, Rotor speed: 150rpm.  
 2. Max. size of granulating: 180x120.

Name	GSL180/120 4-2-2			Customer Confirm	Dwg No.	Sheet	of
Design	Customer			Date			
Appr.	Sales			First Angle			
Rev.	Date						

Zema Machinery & Recycling Technology (Shanghai) Co., Ltd.

**ORIGINAL INSTRUCTION**  
**PART A: Basic machine**  
**Slow speed Granulator A18 Series**

**17.2 A18/18**

**17.2.1 Hopper Nr 1, Frame Nr 1, Suction bin Nr 1**

**Technical Data**  
 1. Motor: 3kw, Rotor speed: 150rpm.  
 2. Max. size of granulating: 180x180.

Name	GSL180/180 1-1-1			Customer Confirm	Date	Sheet	of
Design	Customer						
Appr.	Sales						
Rev.	Date						

Zema Machinery & Recycling Technology (Shanghai) Co., Ltd.



**ORIGINAL INSTRUCTION**  
**PART A: Basic machine**  
**Slow speed Granulator A18 Series**

**17.2.2 Hopper Nr 3, Frame Nr 1, Suction bin Nr 1**

**Technical Data**  
 1. Motor: 3kw, Rotor speed: 150rpm.  
 2. Max. size of granulating: 180x180.

Name	GSL180/180 3-1-1			Customer Confirm	Dwg No.	Sheet	of
Design	Customer			Date			
Appr.	Sales			First Angle			
Rev.	Date						

**ORIGINAL INSTRUCTION**  
**PART A: Basic machine**  
**Slow speed Granulator A18 Series**

**17.2.3 Hopper Nr 4, Frame Nr 1, Suction bin Nr 1**

**Technical Data**  
 1. Motor: 3kw, Rotor speed: 150rpm.  
 2. Max. size of granulating: 180x180.

Name	GSL180/180 4-1-1			Customer Confirm	Dwg No.	Sheet	of
Design	Customer			Date			
Appr.	Sales			First			
Rev.	Date			Angle			

Zema Machinery & Recycling Technology (Shanghai) Co., Ltd.

**ORIGINAL INSTRUCTION**  
**PART A: Basic machine**  
**Slow speed Granulator A18 Series**

**17.2.4 Hopper Nr 1, Frame Nr 2, Suction bin Nr 2**

**Technical Data**  
**1. Motor: 3kw, Rotor speed: 150rpm.**  
**2. Max. size of granulating: 180x180.**

Name	GSL180/180 1-2-2			Customer Confirm	Dwg No.	Sheet	of
Design	Customer			Date			
Appr.	Sales			First			
Rev.	Date			Angle			

ZEMA  
Zerma Machinery & Recycling Technology (Shanghai) Co., Ltd.

**ORIGINAL INSTRUCTION**  
**PART A: Basic machine**  
**Slow speed Granulator A18 Series**

**17.2.5 Hopper Nr 3, Frame Nr 2, Suction bin Nr 2**

**Technical Data**  
 1. Motor: 3kw, Rotor speed: 150rpm.  
 2. Max. size of granulating: 180x180.

Name	GSL180/180 3-2-2	Customer Confirm	Date	Sheet	of
Design	Customer	Customer	Date		
Appr.	Sales	Sales	Date		
Rev.					

  
 Zema Machinery&Recycling  
 Technology(Shanghai)Co.,Ltd.

**ORIGINAL INSTRUCTION**  
**PART A: Basic machine**  
**Slow speed Granulator A18 Series**

**17.2.6 Hopper Nr 4, Frame Nr 2, Suction bin Nr 2**

**Technical Data**  
**1. Motor: 3kw, Rotor speed: 150rpm.**  
**2. Max. size of granulating: 180x180.**

Name	GSL180/180 4-2-2			Customer Confirm	Dwg No.	Sheet	of
Design	Customer	Sales	Date	Date			
Appr.				First Angle			
Rev.							

Zerna Machinery & Recycling Technology (Shanghai) Co., Ltd.

**ORIGINAL INSTRUCTION**  
**PART A: Basic machine**  
**Slow speed Granulator A18 Series**

**17.3 A18/30**

**17.3.1 Hopper Nr 1, Frame Nr 1, Suction bin Nr 1**

**Technical Data**  
 1. Motor: 4kw, Rotor speed: 150rpm.  
 2. Max. size of granulating: 180x300.

Name	GSL180/300 1-1-1			Customer Confirm	Date	Sheet	of
Design	Customer						
Appr.	Sales						
Rev.	Date						

Zema Machinery & Recycling Technology (Shanghai) Co., Ltd.

**ORIGINAL INSTRUCTION**  
**PART A: Basic machine**  
**Slow speed Granulator A18 Series**

**17.3.2 Hopper Nr 3, Frame Nr 1, Suction bin Nr 1**

**Technical Data**  
 1. Motor: 4kw, Rotor speed: 150rpm.  
 2. Max. size of granulating: 180x300.

Name	GSL180/300 3-1-1			Customer Confirm	Dwg No.	Sheet	of
Design	Customer	Sales	Date	Date			
Appr.				First Angle			
Rev.					 ZIMA Machinery & Recycling Technology (Shanghai) Co., Ltd.		

**ORIGINAL INSTRUCTION**  
**PART A: Basic machine**  
**Slow speed Granulator A18 Series**

**17.3.3 Hopper Nr 4, Frame Nr 1, Suction bin Nr 1**

**Control panel with E-Stop**

**Technical Data**  
 1. Motor: 4kw, Rotor speed: 150rpm.  
 2. Max. size of granulating: 180x300.

Name	GSL180/300 4-1-1			Customer Confirm	Dwg No.	Sheet	of
Design	Customer			Date			
Appr.	Sales			First			
Rev.	Date			Angle			



**ORIGINAL INSTRUCTION**  
**PART A: Basic machine**  
**Slow speed Granulator A18 Series**

**17.3.4 Hopper Nr 1, Frame Nr 2, Suction bin Nr 2**

**Technical Data**  
 1. Motor: 4kw, Rotor speed: 150rpm.  
 2. Max. size of granulating: 180x300.

Name	GSL180/300 1-2-2		Customer Confirm	Dwg No.	Sheet	of
Design	Customer		Date			
Appr.	Sales		First Angle			
Rev.	Date					

Zerma Machinery & Recycling Technology (Shanghai) Co., Ltd.

**ORIGINAL INSTRUCTION**  
**PART A: Basic machine**  
**Slow speed Granulator A18 Series**

**17.3.5 Hopper Nr 3, Frame Nr 2, Suction bin Nr 2**

**Technical Data**  
 1. Motor: 4kw, Rotor speed: 150rpm.  
 2. Max. size of granulating: 180x300.

Name	GSL180/300 3-2-2			Customer Confirm	Date	Sheet	of
Design	Customer	Sales	Date	First	Angle	Zerma Machinery & Recycling Technology (Shanghai) Co., Ltd.	
Appr.						ZERMA	
Rev.						ZERMA	

**ORIGINAL INSTRUCTION**  
**PART A: Basic machine**  
**Slow speed Granulator A18 Series**

**17.3.6 Hopper Nr 4, Frame Nr 2, Suction bin Nr 2**

**Control panel with E-Stop**

**Technical Data**  
 1. Motor: 4kw, Rotor speed: 150rpm.  
 2. Max. size of granulating: 180x300.

Name	GSL180/300 4-2-2	Customer Confirm	Dwg No.	Sheet	of
Design	Customer	Date			
Appr.	Sales	First Angle			
Rev.	Date				

Zerna Machinery & Recycling Technology (Shanghai) Co., Ltd.

**ORIGINAL INSTRUCTION**  
**PART A: Basic machine**  
**Slow speed Granulator A18 Series**

**17.4 A18/43**

**17.4.1 Hopper Nr 1, Frame Nr 1, Suction bin Nr 1**

**Technical Data**  
 1. Motor: 4kw, Rotor speed: 150rpm.  
 2. Max. size of granulating: 180x430.

Name	GSL180/430 1-1-1			Customer Confirm	Dwg No.	Sheet	of
Design	Customer	Sales	Date	Date			
Appr.				First			
Rev.				Angle			

Zema Machinery & Technology  
 Technology (Shanghai) Co., Ltd.

**ORIGINAL INSTRUCTION**  
**PART A: Basic machine**  
**Slow speed Granulator A18 Series**

**17.4.2 Hopper Nr 3, Frame Nr 1, Suction bin Nr 1**

**Technical Data**  
**1. Motor: 4kw, Rotor speed: 150rpm.**  
**2. Max. size of granulating: 180x430.**

Name	GSL180/430 3-1-1	Customer Confirm	Dwg No.	Sheet of
Design	Customer	Date		
Appr.	Sales	First Angle		
Rev.	Date			

Zerna Machinery&Recycling Technology(Shanghai)Co.,Ltd.

**ORIGINAL INSTRUCTION**  
**PART A: Basic machine**  
**Slow speed Granulator A18 Series**

**17.4.3 Hopper Nr 4, Frame Nr 1, Suction bin Nr 1**

**Technical Data**  
**1.Motor:4kw,Rotor speed:150rpm.**  
**2.Max. size of granulating:180x430.**

Name	GSL180/430 4-1-1			Customer Confirm		Dwg No.		Sheet	of
Design		Customer		Date					
Appr.		Sales							
Rev.		Date		First Angle					

Zerna Machine&Recycling Technology(Shanghai)Co.,Ltd.

**ORIGINAL INSTRUCTION**  
**PART A: Basic machine**  
**Slow speed Granulator A18 Series**

**17.4.4 Hopper Nr 5, Frame Nr 1, Suction bin Nr 1**

**Technical Data**  
**1.Motor:4kw,Rotor speed:150rpm.**  
**2.Max. size of granulating:180x430.**

Name	GSL180/430 5-1-1			Customer Confirm		Dwg No.		Sheet	of
Design		Customer		Date					
Appr.		Sales		Date					
Rev.		Date		First Angle					

**ORIGINAL INSTRUCTION**  
**PART A: Basic machine**  
**Slow speed Granulator A18 Series**

**17.4.5 Hopper Nr 1, Frame Nr 2, Suction bin Nr 2**

**Technical Data**  
**1. Motor: 4kw, Rotor speed: 150rpm.**  
**2. Max. size of granulating: 180x430.**

Name	GSL180/430 1-2-2			Customer Confirm	Dwg No.	Sheet	of
Design	Customer			Date			
Appr.	Sales			First Angle			
Rev.	Date						

Zema Machinery & Recycling Technology (Shanghai) Co., Ltd.



**ORIGINAL INSTRUCTION**  
**PART A: Basic machine**  
**Slow speed Granulator A18 Series**

**17.4.6 Hopper Nr 3, Frame Nr 2, Suction bin Nr 2**

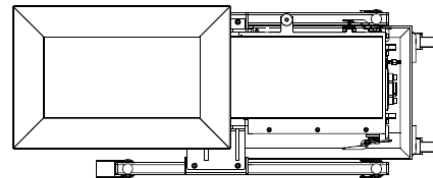
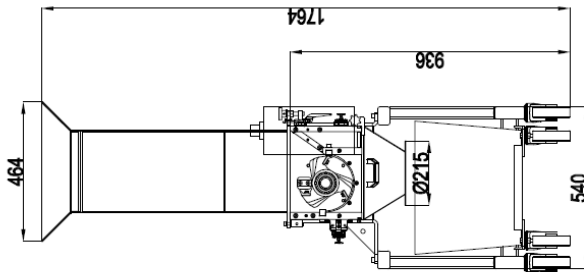
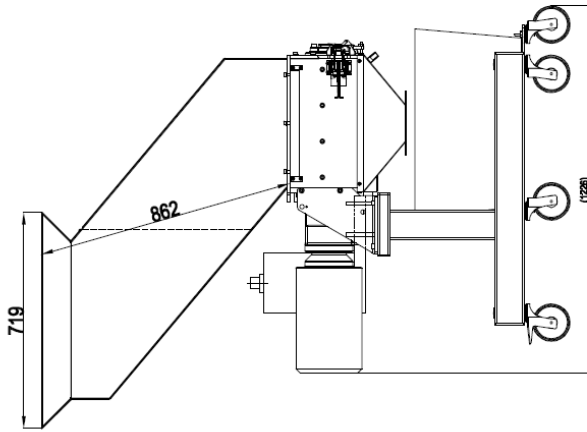

**Technical Data**  
**1. Motor: 4kw, Rotor speed: 150rpm.**  
**2. Max. size of granulating: 180x430.**

Name	GSL180/430 3-2-2			Customer Confirm	Dwg No.	Sheet	of
Design	Customer			Date			
Appr.	Sales			First Angle			
Rev.	Date						



**ORIGINAL INSTRUCTION**  
**PART A: Basic machine**  
**Slow speed Granulator A18 Series**

**17.4.7 Hopper Nr 4, Frame Nr 2, Suction bin Nr 2**

**Technical Data**  
**1. Motor: 4kw, Rotor speed: 150rpm.**  
**2. Max. size of granulating: 180x430.**

Name	GSL180/430 4-2-2		Customer Confirm	Dwg No.	Sheet of
Design	Customer		Date		
Appr.	Sales		First Angle		
Rev.	Date				

Zerna Machinery&Recycling Technology(Shanghai)Co.,Ltd.

**ORIGINAL INSTRUCTION**  
**PART A: Basic machine**  
**Slow speed Granulator A18 Series**

**17.4.8 Hopper Nr 5, Frame Nr 2, Suction bin Nr 2**

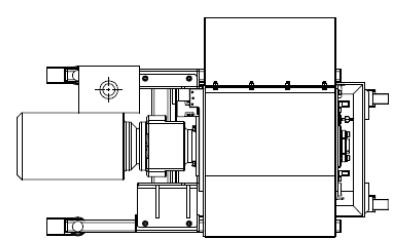
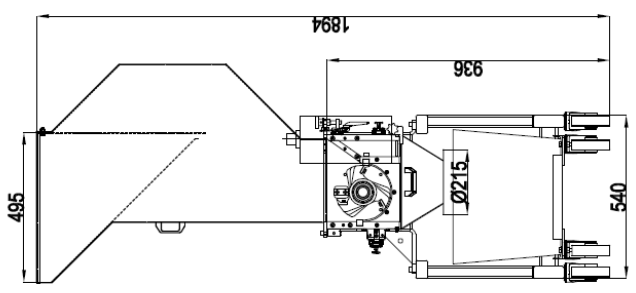
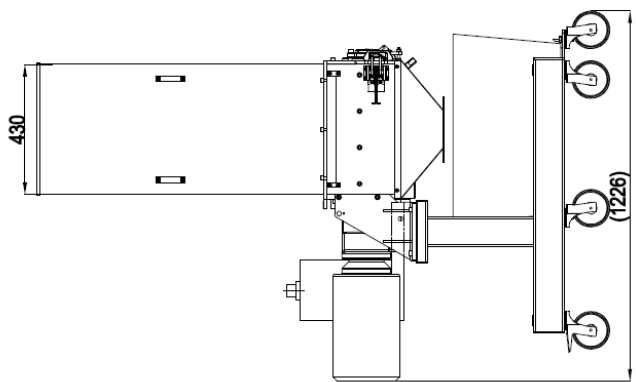

**Technical Data**  
**1. Motor: 4kw, Rotor speed: 150rpm.**  
**2. Max. size of granulating: 180x430.**

Name	GSL180/430 5-2-2		Customer Confirm	Dwg No.	Sheet	of
Design	Customer		Date			
Appr.	Sales		First Angle			
Rev.	Date					
 Zerna Machine & Recycling Technology (Shanghai) Co., Ltd.						

**ORIGINAL INSTRUCTION**  
**PART A: Basic machine**  
**Slow speed Granulator A18 Series**

**18 ELECTRICAL CONNECTION**

**18.1 A18/12 Standard wiring diagram**

1	2	3	4	5	6	7	8
 <p><b>Zerma Machinery &amp; Recycling Technology(Shanghai)Co.,Ltd.</b>          5 Xinjie Rd XinQiao Township Ind.Park Songjiang Shanghai,China          Tel. 0086-21-57645573          Fax 0086-21-57646766</p>							
Order number		Code		Type		Power supply	
				GSL(2.2KW)		Control voltage	
Created on		2012-7-5		Number of pages		9	
						Version NO.	
						Date	
						xuhongmei	
						Name	

Rev'n	Date	Name	Checked	Date	Substitute for	Replaced with
	2012-7-5	xuhongmei	Norm			

  

Zerma Machinery & Recycling Technology(Shanghai) Co.,Ltd 5 Xinjie Rd XinQiao Township Ind.Park Songjiang Shanghai,China Tel. 0086-21-57645573 Fax 0086-21-57646766		GSL(2.2KW)	=	+	Page of
					0 9

# ORIGINAL INSTRUCTION

## PART A: Basic machine

### Slow speed Granulator A18 Series

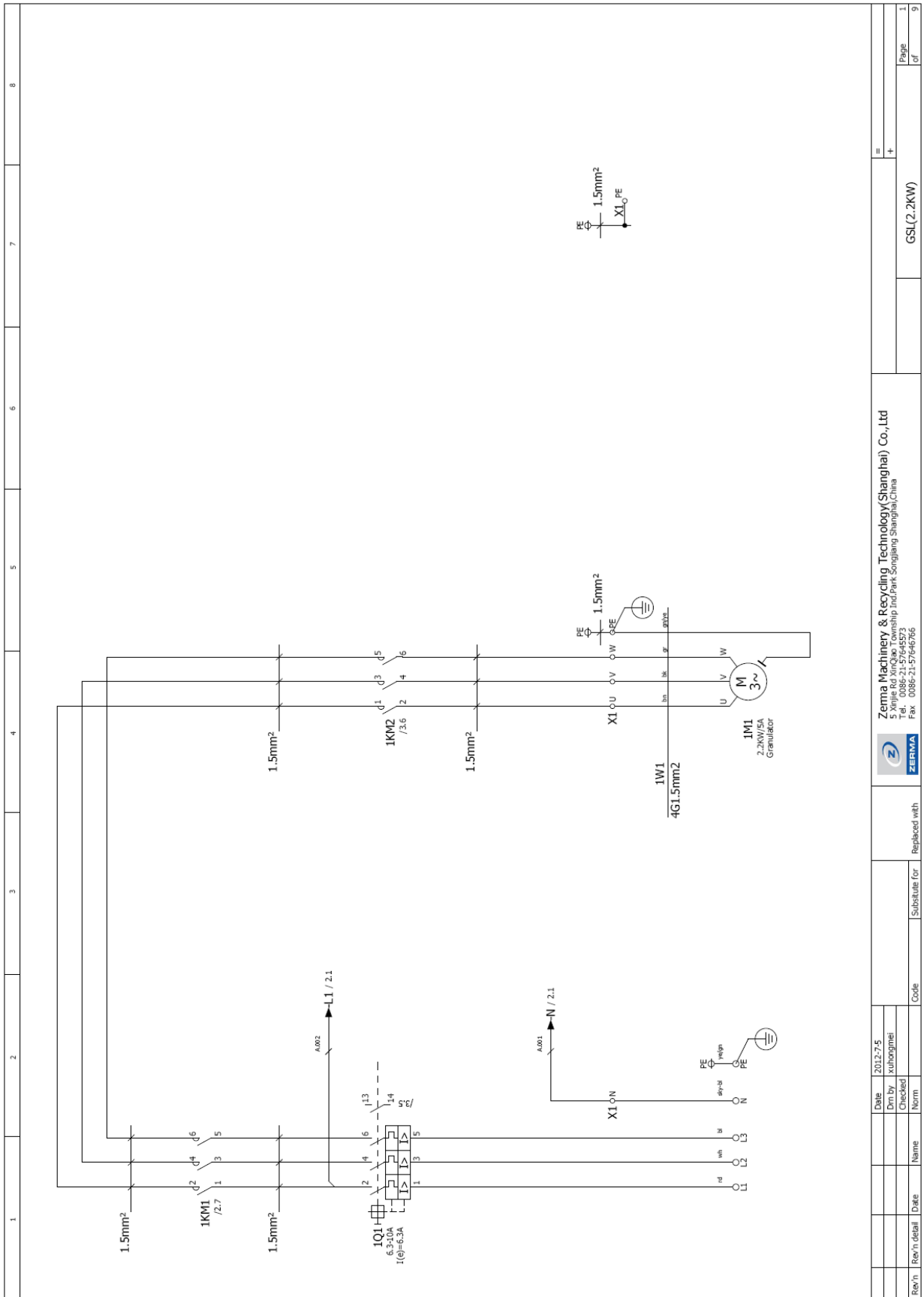

Rev'n	Rev'n detail	Date	Name	Code	Substitute for	Replaced with	 <b>ZEMMA</b>	<b>Zemna Machinery &amp; Recycling Technology(Shanghai) Co.,Ltd</b> 5 Xinjie Rd Xinqiao Township Ind/Park Songjiang Shanghai,China Tel: 0086-21-57446763 Fax: 0086-21-57446766	GSI(2.2KW)	Page	1
										of	9

# ORIGINAL INSTRUCTION

## PART A: Basic machine

### Slow speed Granulator A18 Series

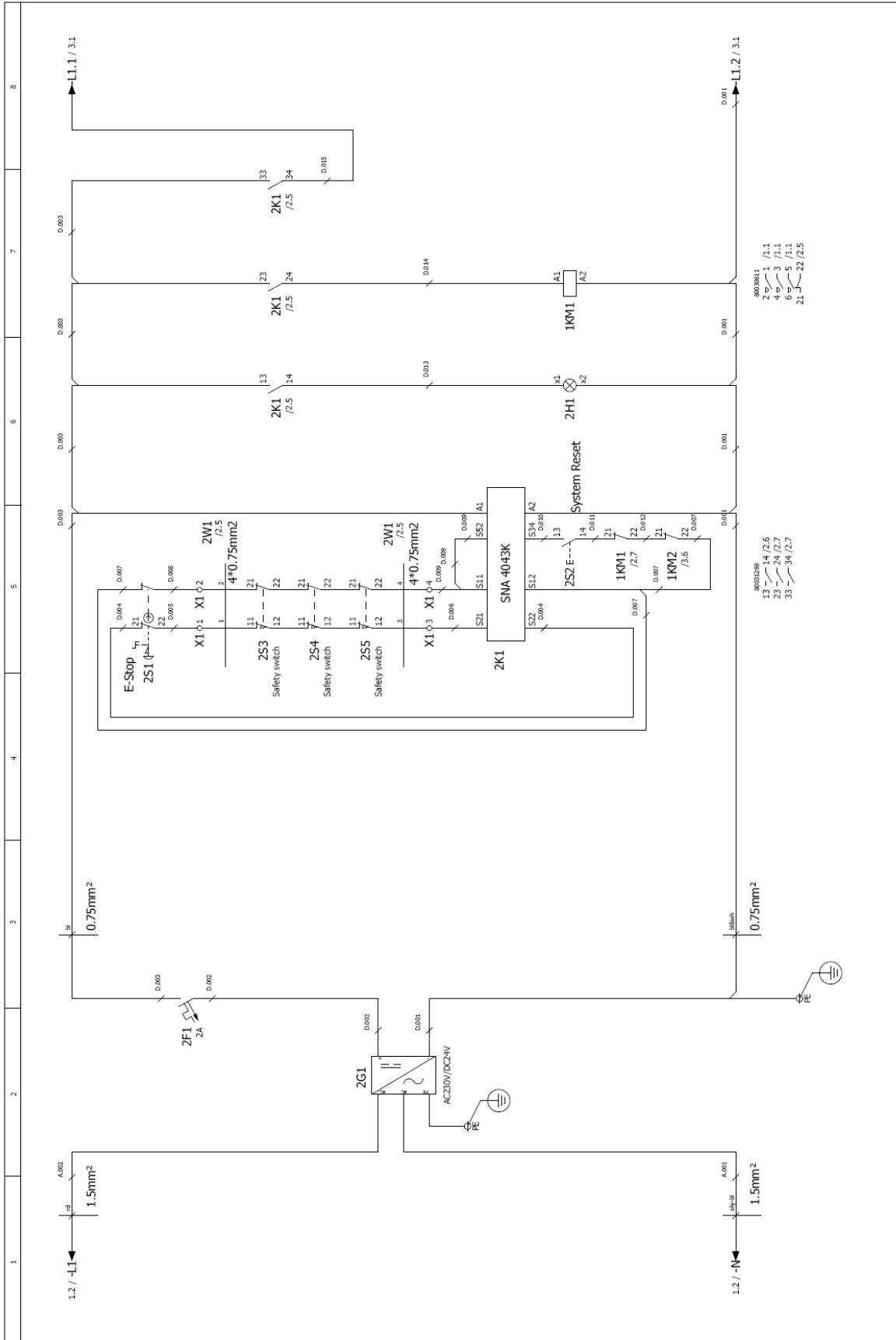

Rev'n	Rev'n detail	Date	Name	Code	Substitute for	Replaced with
		2012-7-5				
		Drawn by	Zhangmei			
		Checked				
		Norm				

  

Zerma Machinery & Recycling Technology(Shanghai) Co.,Ltd 5 Xinjie Rd Xinqiao Township Ind/Park Songjiang Shanghai,China Tel: 0086-21-57494763 Fax: 0086-21-57494766		ZERMA	GSL(2.2KW)		#
Page	of				
2	9				

# ORIGINAL INSTRUCTION

## PART A: Basic machine

### Slow speed Granulator A18 Series

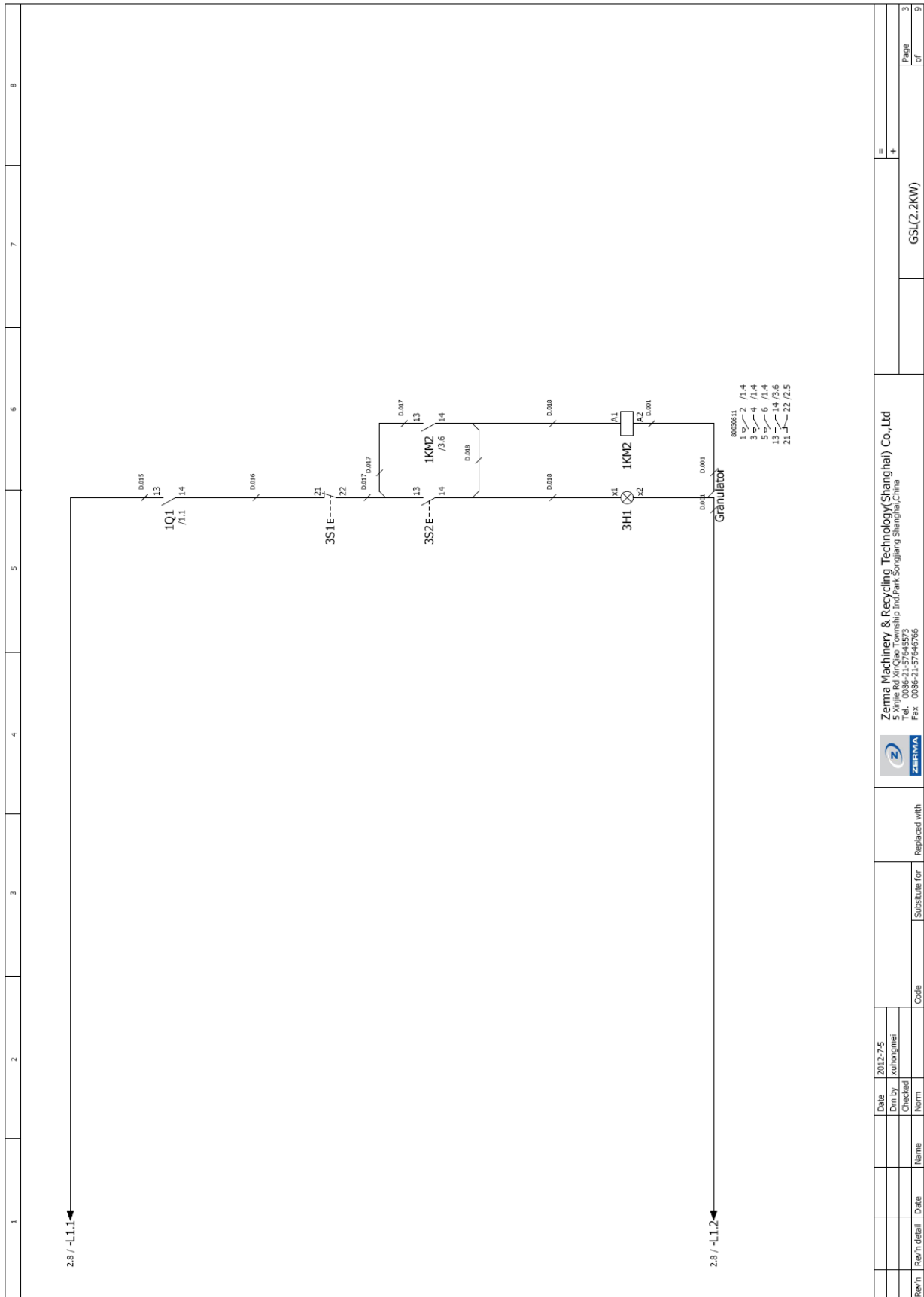

Rev'n	Rev'n detail	Date	Name	Norm	Code	Substitute for	Replaced with	 <b>ZERMA</b>	<b>Zerma Machinery &amp; Recycling Technology (Shanghai) Co., Ltd</b> Xinyuan Road, Songjiang District, Shanghai, China Tel: 0086-21-54545272 Fax: 0086-21-57546765	GSL(2.2KW)	Page	3
							Of				9	

# ORIGINAL INSTRUCTION

## PART A: Basic machine

### Slow speed Granulator A18 Series

Terminal diagram										
Function text	Cable name		Cable type		Target designation		Terminal		Page / column	
Granulator	-1W1	4G1.5mm2	gr/ve	bn	N	-2G1	•	PE	1.2	
	-2W1	4*0.75mm2	bk	gr	PE	-1PE	•		1.5	
Safety switch					U	-1K02	•		1.4	
					V	-1K02	•		1.4	
					W	-1K02	•		1.4	
					11	-2S1	•		2.5	
				2	-2S1	•		2.5		
				3	-2K1	•		2.5		
				4	-2K1	•		2.5		
					PE	•		1.7		

Rev'n	Rev'n detail	Date	Name	Checked	Norm	Substitute for	Code	Replaced with
		2012-7-5	XuHongmei					
 <b>ZERMA</b>								
<b>Zerma Machinery &amp; Recycling Technology(Shanghai) Co.,Ltd</b> 5 Xujie Rd XinQiao Township Ind/Park Songjiang Shanghai,China Tel: 0086-21-57646763 Fax: 0086-21-57646766								GS(L2.2KW)
								Page of
								4
								9



# ORIGINAL INSTRUCTION

## PART A: Basic machine

### Slow speed Granulator A18 Series

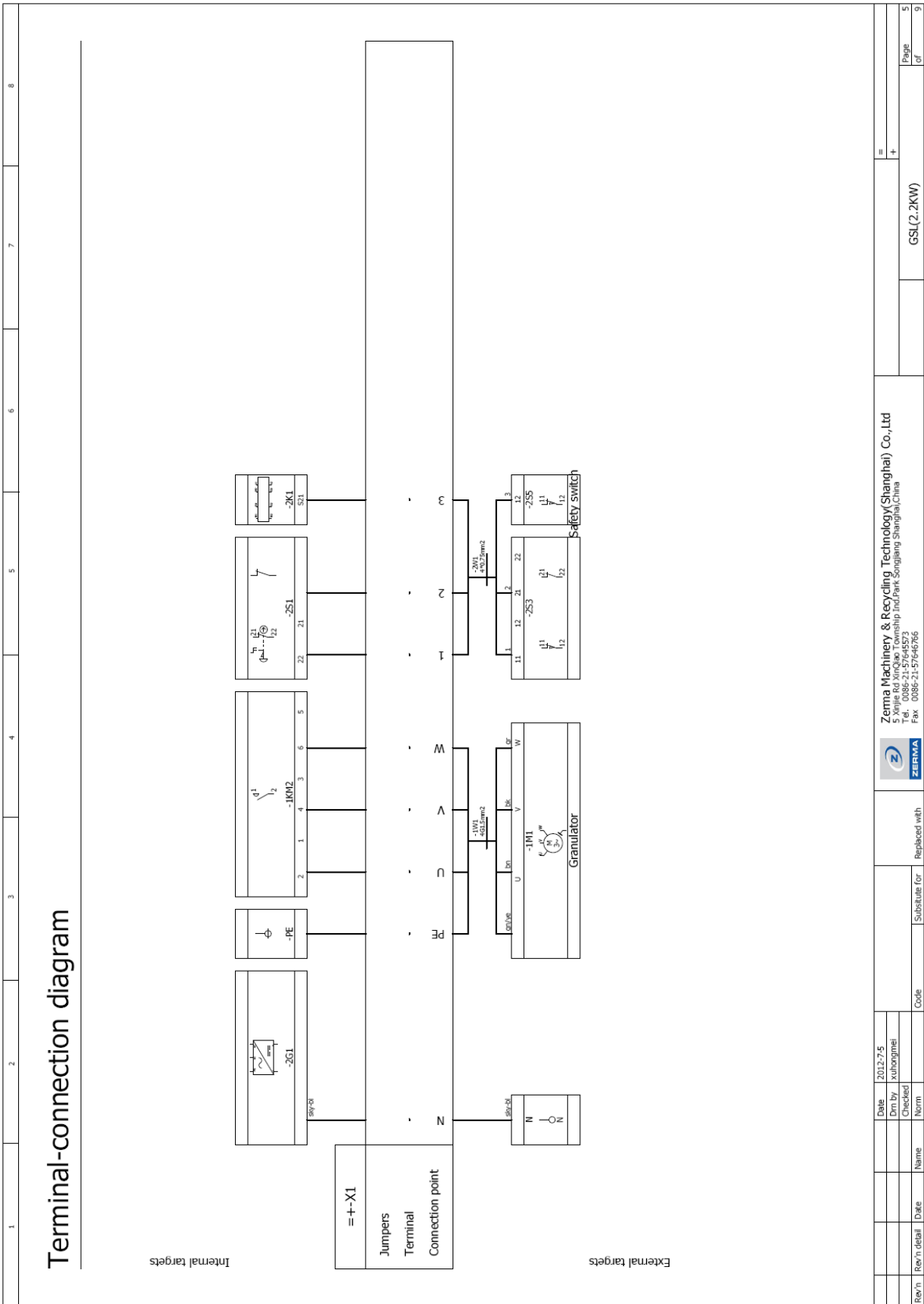

1	2	3	4	5	6	7	8	9	
Rev'n	Rev'n detail	Date	Name	Norm	Checked	Code	Substitute for	Replaces with	
		2012-7-5	Xinrongmei						
								ZERMA	
								Zerma Machinery & Recycling Technology(Shanghai) Co., Ltd	
								Xinrongmei Technology Co., Ltd	
								Address: Songjiang Industrial Park, Songjiang, Shanghai, China	
								Tel: 0086-21-57646279	
								Fax: 0086-21-57646265	
								GSL(2.2KW)	
								+	
								=	
								Page	5
								of	9

# ORIGINAL INSTRUCTION

## PART A: Basic machine

### Slow speed Granulator A18 Series

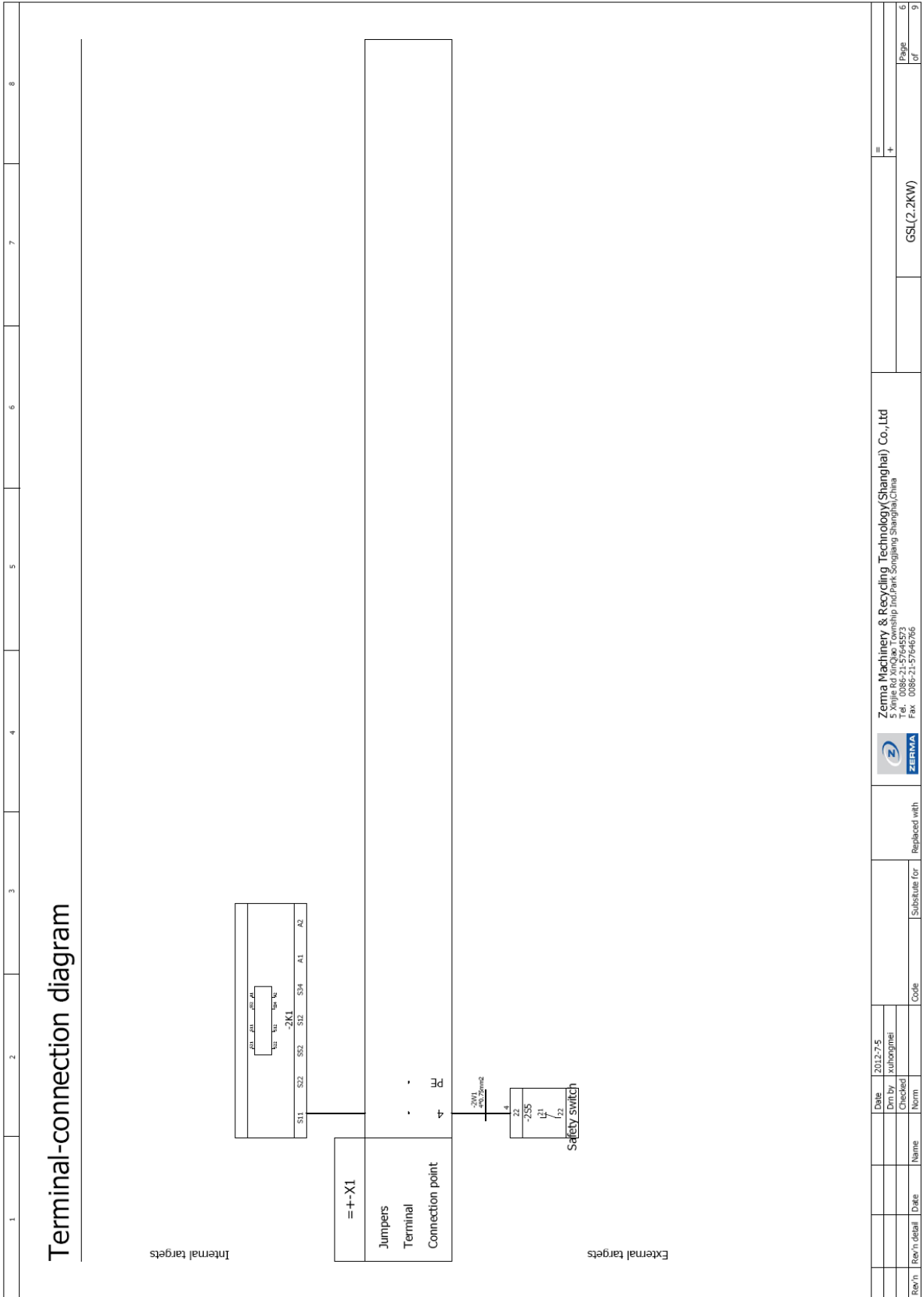

# ORIGINAL INSTRUCTION

## PART A: Basic machine

### Slow speed Granulator A18 Series

1	2	3	4	5	6	7	8
<b>Summarized parts list</b>							
Material number	Quantity	Component Name	Description	Reference name	Manufacturer		
80007280	1	Control box	AE1035.500 (W*H*D 200*300*155)		RITTAL		
80031186	1	PE busbar	3x17/5 piece		Leipole		
80031372	1	Mould case circuit breaker DC2A	PL9-C2-DC	2F1	Moeller		
80031257	1	Power supply 48W DC24V 2A	CP SNT 48W 24V 2A	2G1	Weidmuller		
80005940	5	Fixing adapter	M22-A	2H1;2S1;3H1;3S1;3S2	Moeller		
80030309	1	Label	M22-XST	2H1	Moeller		
80030308	1	Label mount	M22S-ST-X	2H1	Moeller		
80031028	1	Indicator&pushbutton(white)	M22-DL-W	2H1	Moeller		
80005470	3	Contact element NO	M22-K10	2H1;3H1;3S2	Moeller		
80008130	2	Bulb&lamp socket (white/yellow)	M22-LED-W	2H1;3H1	Moeller		
80031027	1	Double actuator	M22-BDL-GR-X1/X0	3H1	Moeller		
80005450	4	Contact element NC	M22-K01	2S1;3H1;3S1	Moeller		
80031269	1	Safety monitoring DC24V	SNA 4043K(DC24V)R1.188.1680.0	2K1	Wieland		
80030611	2	Power contactor	DILM9-10C(24VDC)	1KM1;1KM2	Moeller		
80030725	2	Auxiliary contact module	DILM32C-XH111	1KM1;1KM2	Moeller		
80031043	1	Motor-protective circuit breaker	PKZMC-10	1Q1	Moeller		
80005110	1	Auxiliary contact	NH11-PKZ0	1Q1	Moeller		
80031019	1	Emergency stop actuator	M22-PV	2S1	Moeller		
80030438	3	Safety switch	AZ16-02ZVRK	2S3...2S5	Schmersal		

Rev'n	Rev'n detail	Date	Name	Checked	Norm	Code	Substitute for	Replaced with	Zerma Machinery & Recycling Technology (Shanghai) Co., Ltd 5 Xujie Rd Xinqiao Township Ind.Park Songjiang Shanghai, China Tel: 0086-21-57646766 Fax: 0086-21-57646766		GSL(2.2KW)	Page of
		2012-7-5		2012-7-5								7
												9





# ORIGINAL INSTRUCTION

## PART A: Basic machine

### Slow speed Granulator A18 Series

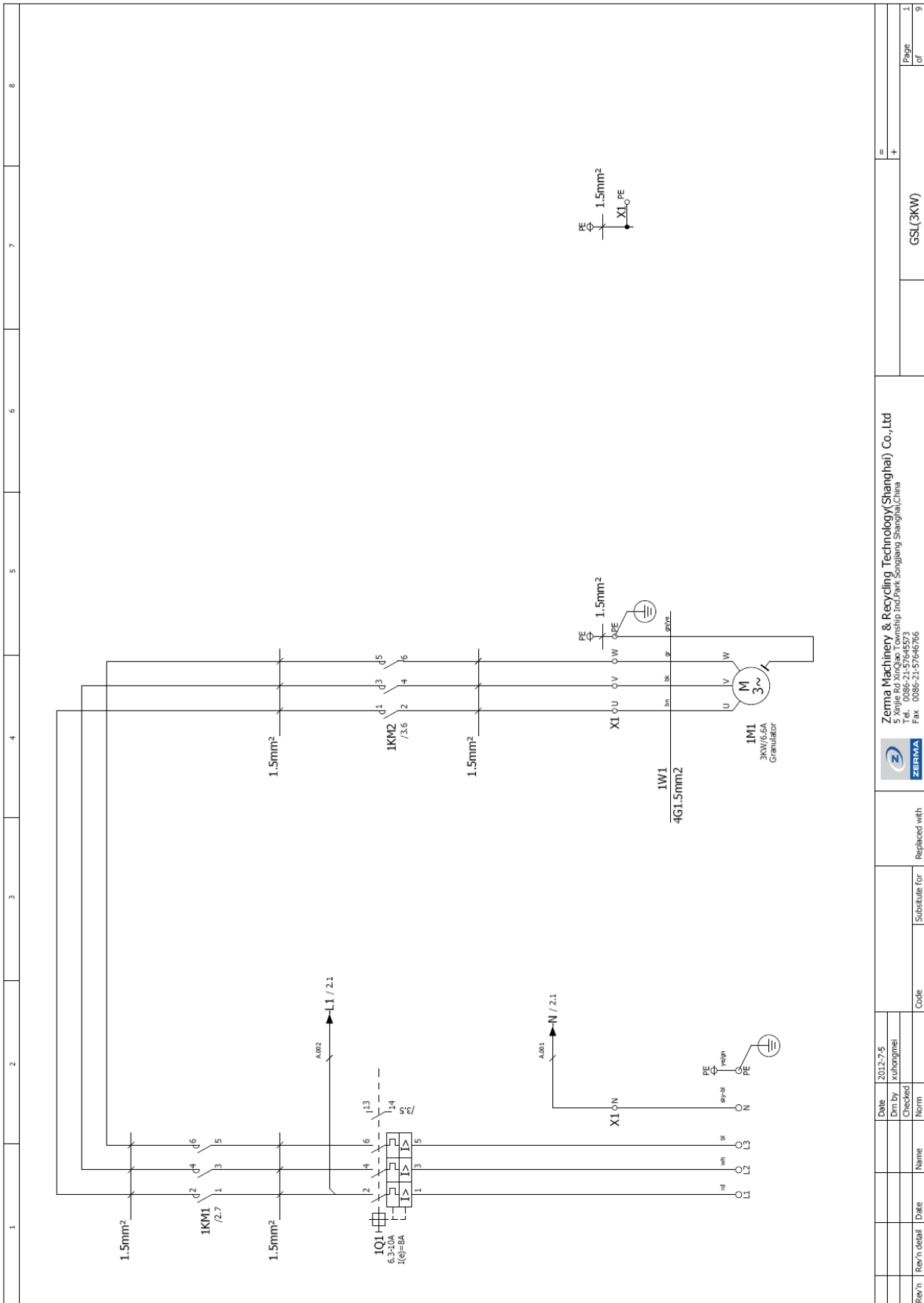

Rev'n	Rev'n detail	Date	Name	Norm	Checked	Code	Substitute for	Replaced with
		2012-7-5						
		Drawn by	XuHongmei					

Zerma Machinery & Recycling Technology (Shanghai) Co., Ltd		GSL(3KW)	
5 Xingjie Rd Xinqiao Township Ind/Park Songjiang Shanghai, China			
Tel: 0086-21-57946765			
Fax: 0086-21-57946766			

  

Page	1
of	9

# ORIGINAL INSTRUCTION

## PART A: Basic machine

### Slow speed Granulator A18 Series

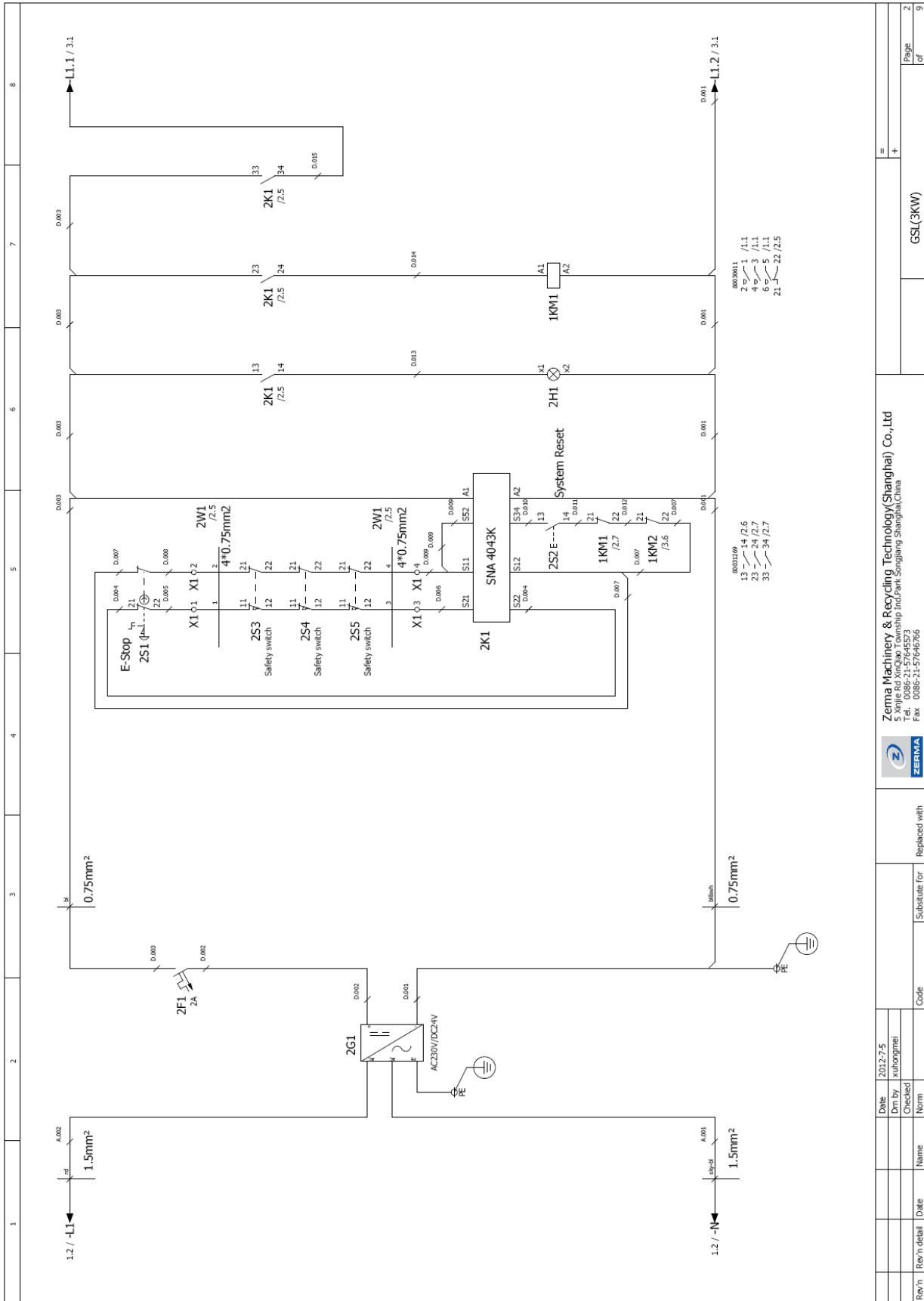

Rev'n	Rev'n detail	Date	Name	Code	Substitute for	Replaced with
		2012-7-5	XuHongmei			
		Checked	Norm			
						GSL(3KW)
						Page 2
						of 9

Zerma Machinery & Recycling Technology(Shanghai) Co.,Ltd  
 5 Xinjie Rd XinQiao Township Ind/Park Songjiang Shanghai,China  
 Tel: 0086-21-57946763  
 Fax: 0086-21-57946766



# ORIGINAL INSTRUCTION

## PART A: Basic machine

### Slow speed Granulator A18 Series

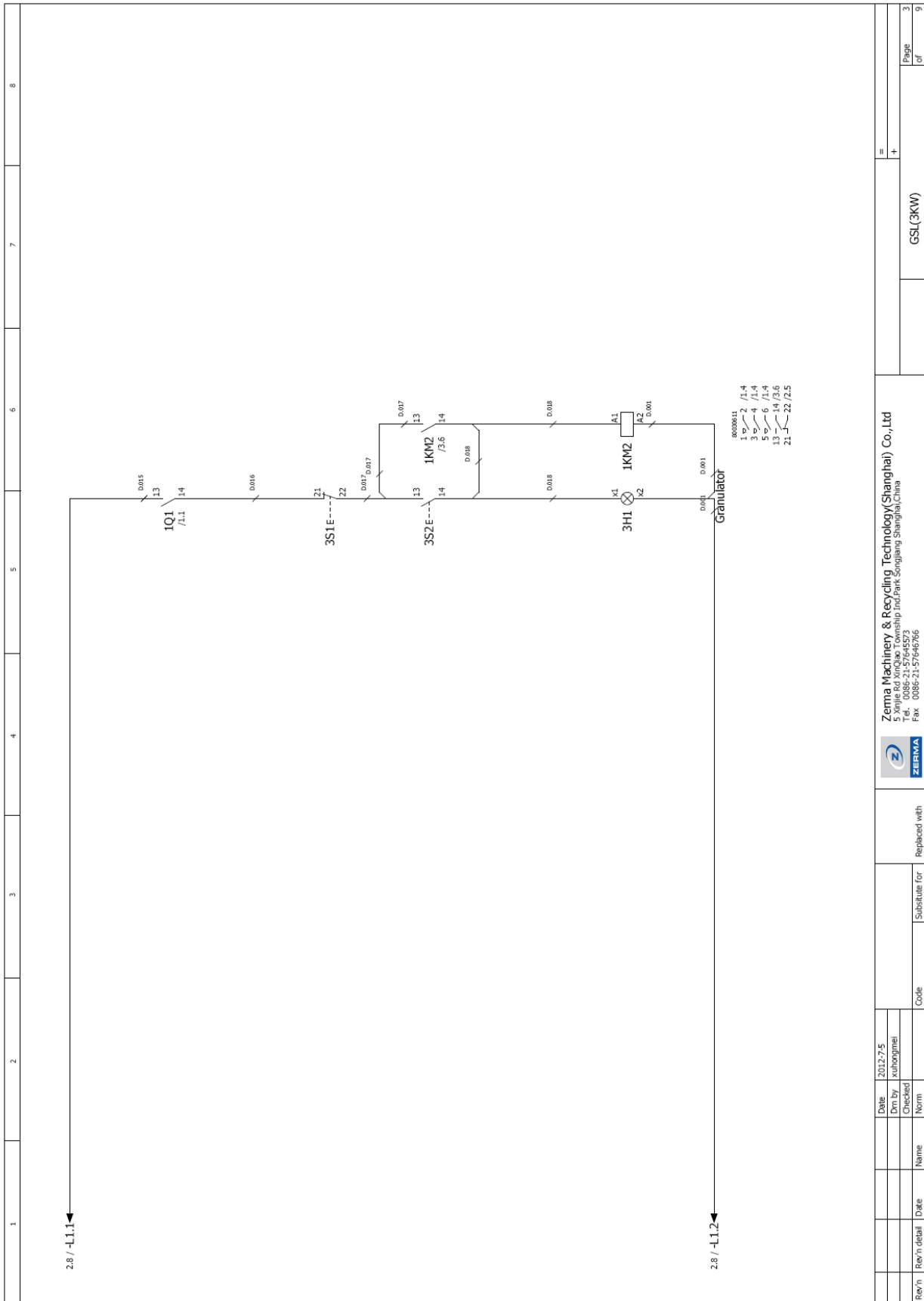

2.8 / -L1.1	1	2	3	4	5	6	7	8
2.8 / -L1.2								
Revised	Revised	Date	2012.7.5	Drawn by	xiubogmail	Revised		
Checked	Norm	Name		Code		Replaces with		
						Substitute for		
						GSL(3KW)		
						Page 3 of 3		

Zerma Machinery & Recycling Technology(Shanghai) Co.,Ltd  
 5 Xiangjie Rd Xinqiao Township Ind/Park Songjiang Shanghai,China  
 Fax: 0086-21-57646765







# ORIGINAL INSTRUCTION

## PART A: Basic machine

### Slow speed Granulator A18 Series

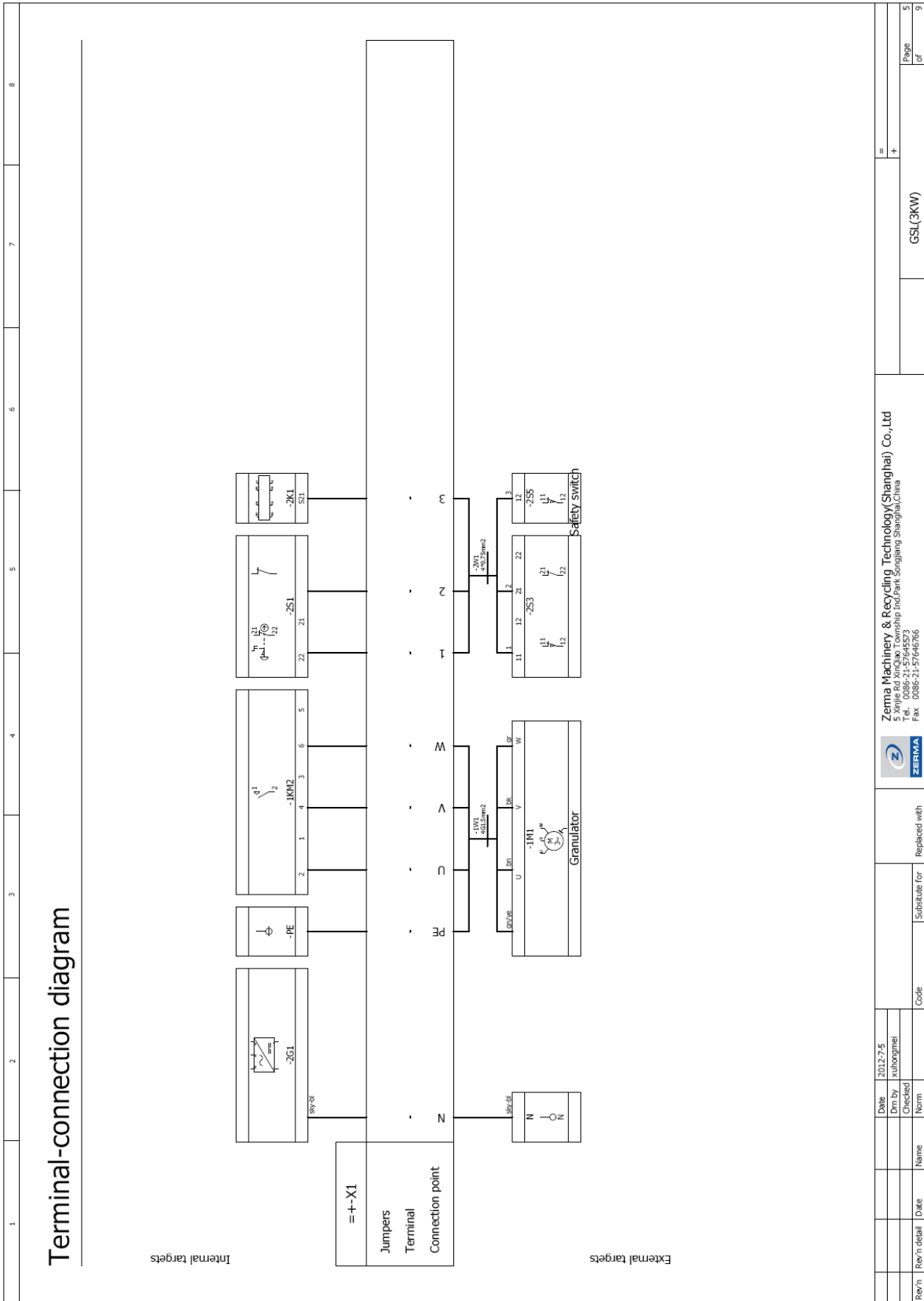

Rev'n	Rev'n detail	Date	Name	Norm	Code	Substitute for	Replaced with	ZERMA	Zerma Machinery & Recycling Technology (Shanghai) Co., Ltd 5 Xinjie Rd XinQiao Townshp Ind/Park Songjiang Shanghai,China Tel: 021-57646765 Fax: 0086-21-57646766	GSL(3KW)	Page of
											5 9

# ORIGINAL INSTRUCTION

## PART A: Basic machine

### Slow speed Granulator A18 Series

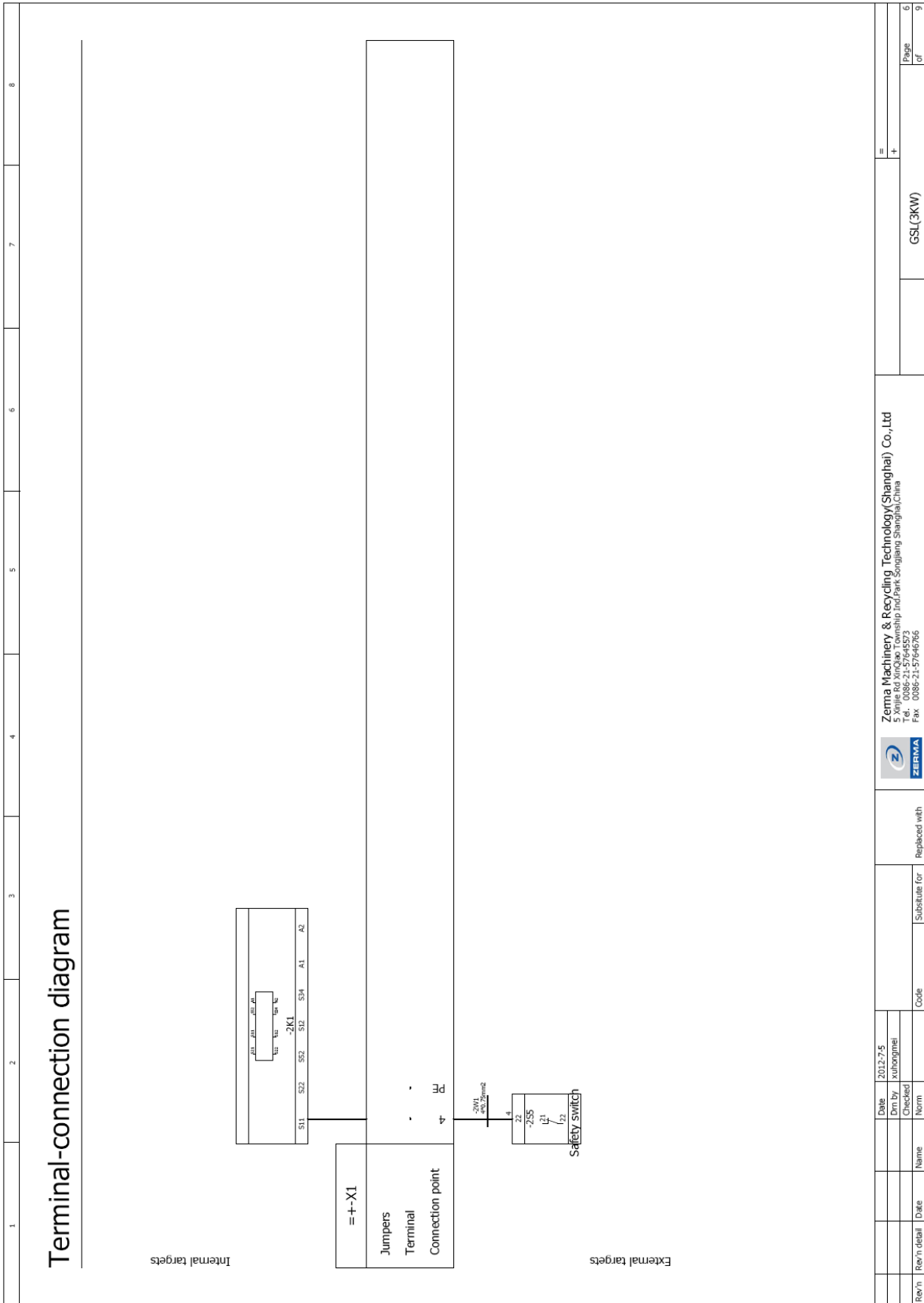

1	2	3	4	5	6	7	8
---	---	---	---	---	---	---	---

Rev'n	Rev'n detail	Date	Name	Norm	Checked	Date	Code	Substitute for	Replaced with	ZERMA	Zerma Machinery & Recycling Technology (Shanghai) Co., Ltd 5 Xingjie Rd Xinqiao Township Ind/Park Songjiang Shanghai, China Tel: 0086-21-57646766 Fax: 0086-21-57646766	GSL(3KW)	Page of
		2012-7-5	Zuohongmei										6
													9

# ORIGINAL INSTRUCTION

## PART A: Basic machine

### Slow speed Granulator A18 Series

1	2	3	4	5	6	7	8
<b>Summarized parts list</b>							
Material number	Quantity	Component Name	Description	Reference name	Manufacturer		
80007280	1	Control box	AE1035.500 (W*H*D 200*300*155)		RITTAL		
80031186	1	PE busbar	3×17/5 piece		Leipole		
80031372	1	Mould case circuit breaker DC2A	PL9-C2-DC	2F1	Moeller		
80031257	1	Power supply 48W DC24V 2A	CP SNT 48W 24V 2A	2G1	Weidmuller		
80005940	5	Fixing adapter	M22-A	2H1;2S1;3H1;3S1;3S2	Moeller		
80030309	1	Lable	M22-XST	2H1	Moeller		
80030308	1	Lable mount	M22S-ST-X	2H1	Moeller		
80031028	1	Indicator&pushbutton(white)	M22-DL-W	2H1	Moeller		
80005470	3	Contact element NO	M22-K10	2H1;3H1;3S2	Moeller		
80008130	2	Bulb&lamp socket (white/yellow)	M22-LED-W	2H1;3H1	Moeller		
80031027	1	Double actuator	M22-DDL-GR-X1/X0	3H1	Moeller		
80005450	4	Contact element NC	M22-K01	2S1;3H1;3S1	Moeller		
80031269	1	Safety monitoring DC24V	SNA 4043K(DC24V)R1.188.1680.0	2K1	Wieland		
80030611	2	Power contactor	DILM9-10C(24VDC)	1KM1;1KM2	Moeller		
80030725	2	Auxiliary contact module	DILM32C-XH11	1KM1;1KM2	Moeller		
80031043	1	Motor-protective circuit breaker	PKZMC-10	1Q1	Moeller		
80005110	1	Auxiliary contact	NH11-PKZ0	1Q1	Moeller		
80031019	1	Emergency stop actuator	M22-PV	2S1	Moeller		
80030438	3	Safety switch	AZ16-02ZVRK	2S1...2S5	Schmersal		

Revised	Date	2012-7-5	Checked	Norm	Code	Substitute for	Replaces with	 <b>ZERMA</b>	<b>Zerma Machinery &amp; Recycling Technology(Shanghai) Co.,Ltd</b> 5 Xiale Rd Xinqiao Township Ind/Park Songjiang Shanghai,China Fax: 0086-21-57646765	GSL(3KW)	= +	Page	7
Revised	Date		Checked	Norm	Code	Substitute for	Replaces with					of	9





# ORIGINAL INSTRUCTION

## PART A: Basic machine

### Slow speed Granulator A18 Series

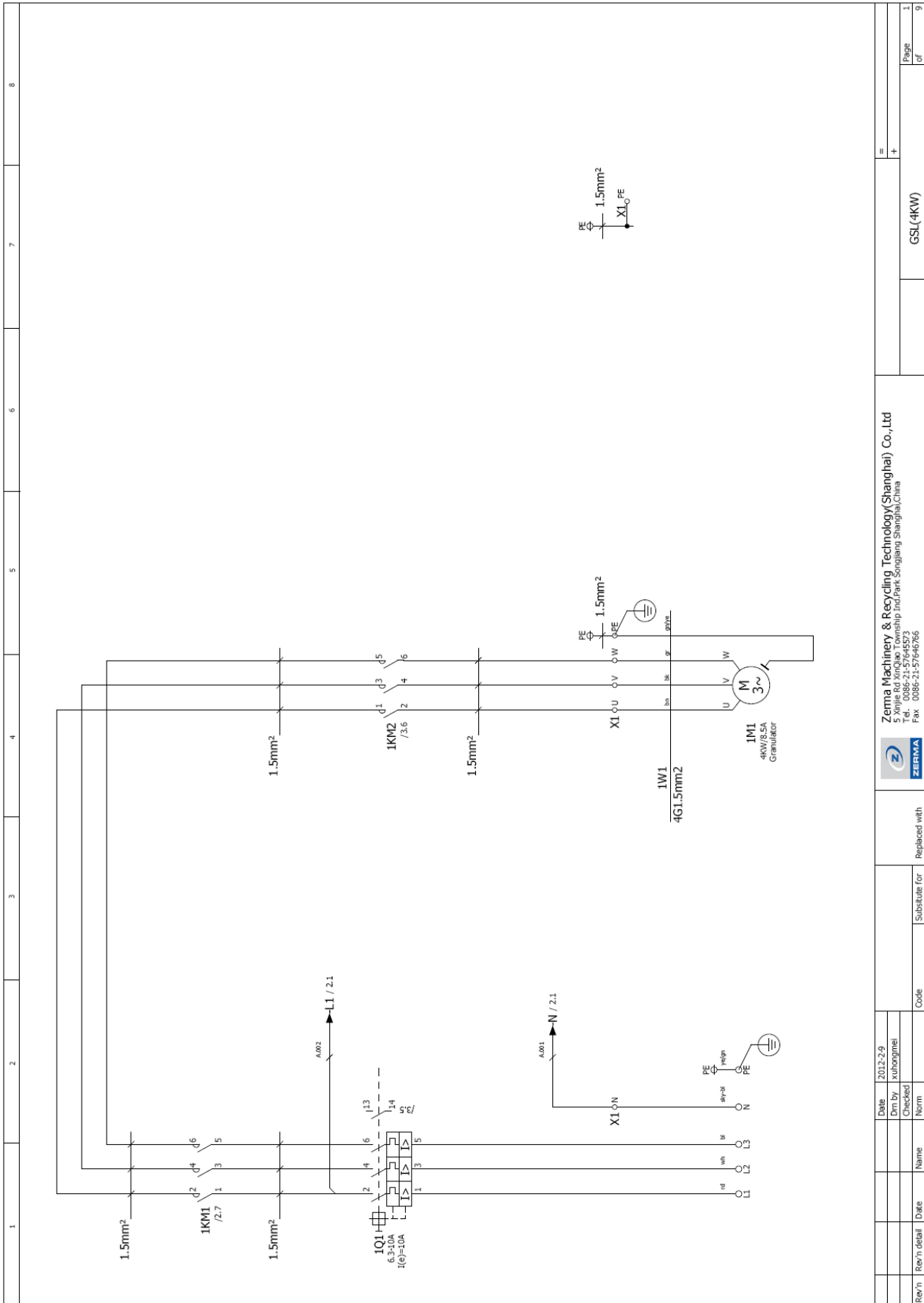

Rev'n	Rev'n detail	Date	Name	Norm	Checked	Des' by	Date	Code	Substitute for	Replaced with
		2012-2-9				XuHongmei				

  

Zerma Machinery & Recycling Technology(Shanghai) Co.,Ltd 5 Xingjie Rd Xinqiao Township Ind/Park Songjiang Shanghai,China Fax: 0086-21-57646765		GSL(4KW)	
Page of	1	3	

# ORIGINAL INSTRUCTION

## PART A: Basic machine

### Slow speed Granulator A18 Series

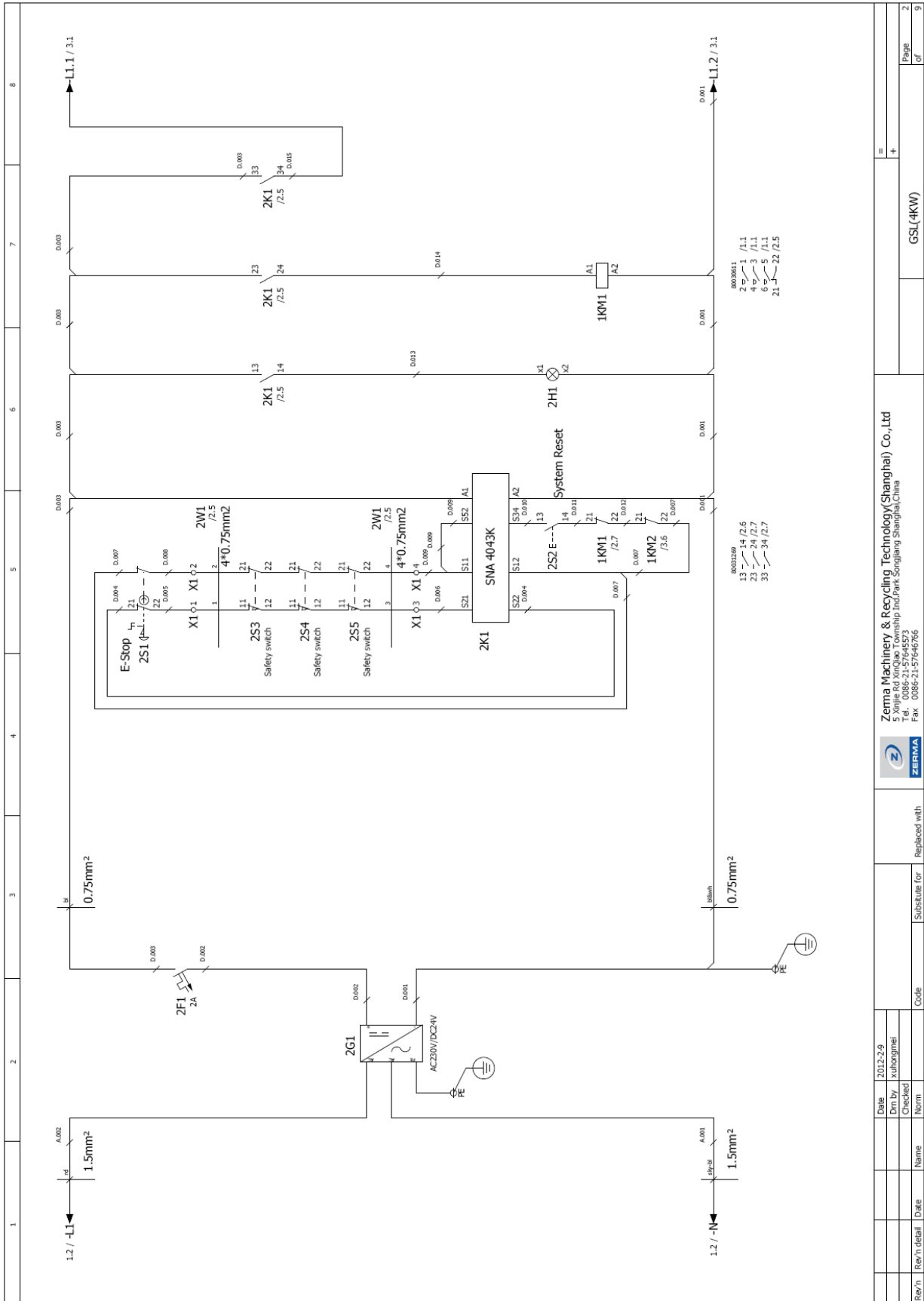

Rev'n	Rev'n detail	Date	Name	Code	Substitute for	Replaced with
		2012-2-9	xixiangmei			
		Checked				
		Norm				
Zerma Machinery & Recycling Technology(Shanghai) Co., Ltd Xinjie Road, Songjiang District, Shanghai, China Tel: 0086-21-57464577 Fax: 0086-21-57464765						
GSL(4KW)						
						Page
						2
						of
						9



# ORIGINAL INSTRUCTION

## PART A: Basic machine

### Slow speed Granulator A18 Series

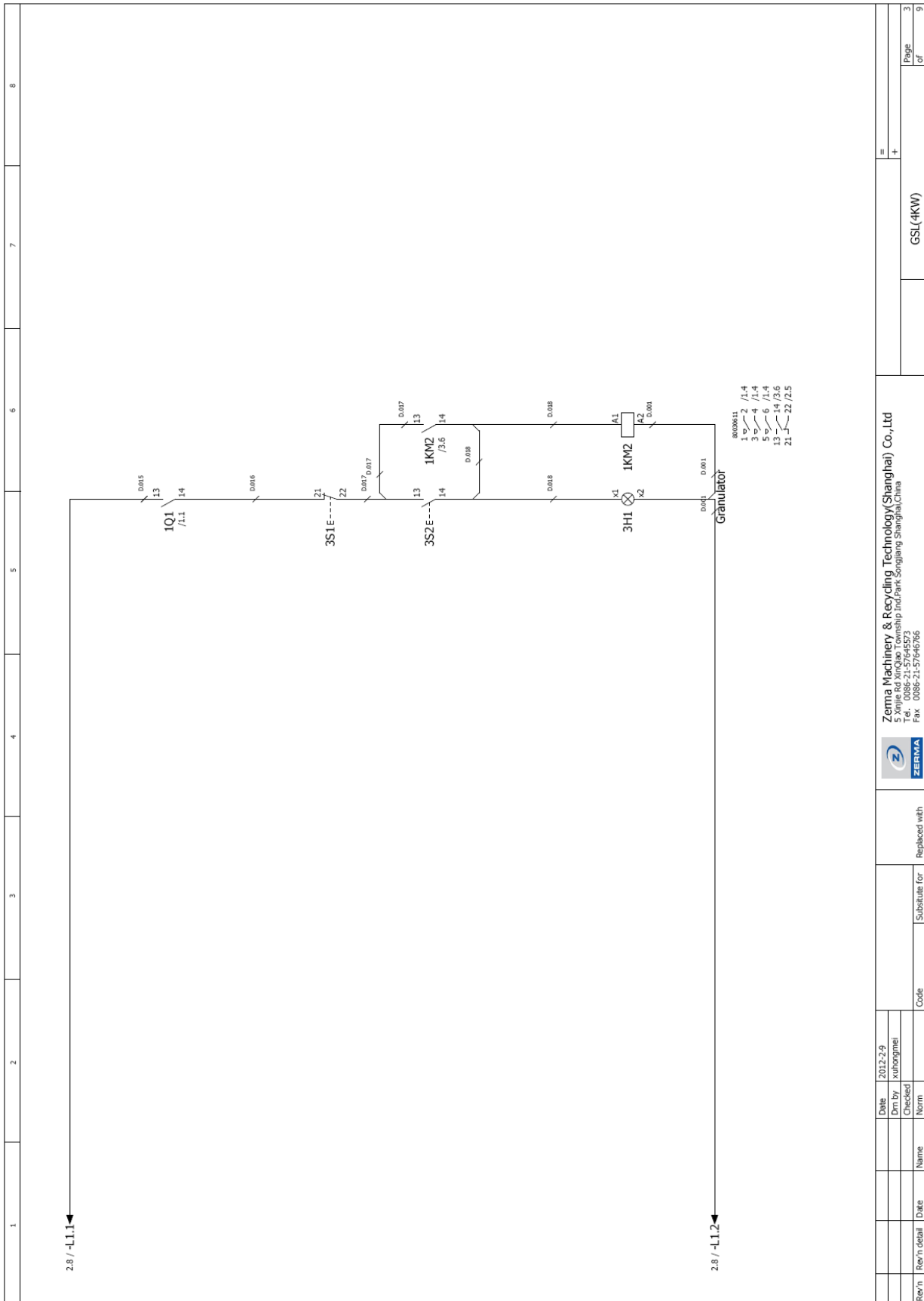

Rev'n	Rev'n detail	Date	Name	Norm	Code	Substitute for	Replaced with	 <b>ZERMA</b>	<b>Zerma Machinery &amp; Recycling Technology(Shanghai) Co.,Ltd</b> 5 Xinjie Rd Xinqiao Township Ind/Park Songjiang Shanghai,China Tel: 0086-21-57646766 Fax: 0086-21-57646766	GSL(4KW)	Page	3
											of	9



# ORIGINAL INSTRUCTION

## PART A: Basic machine

### Slow speed Granulator A18 Series

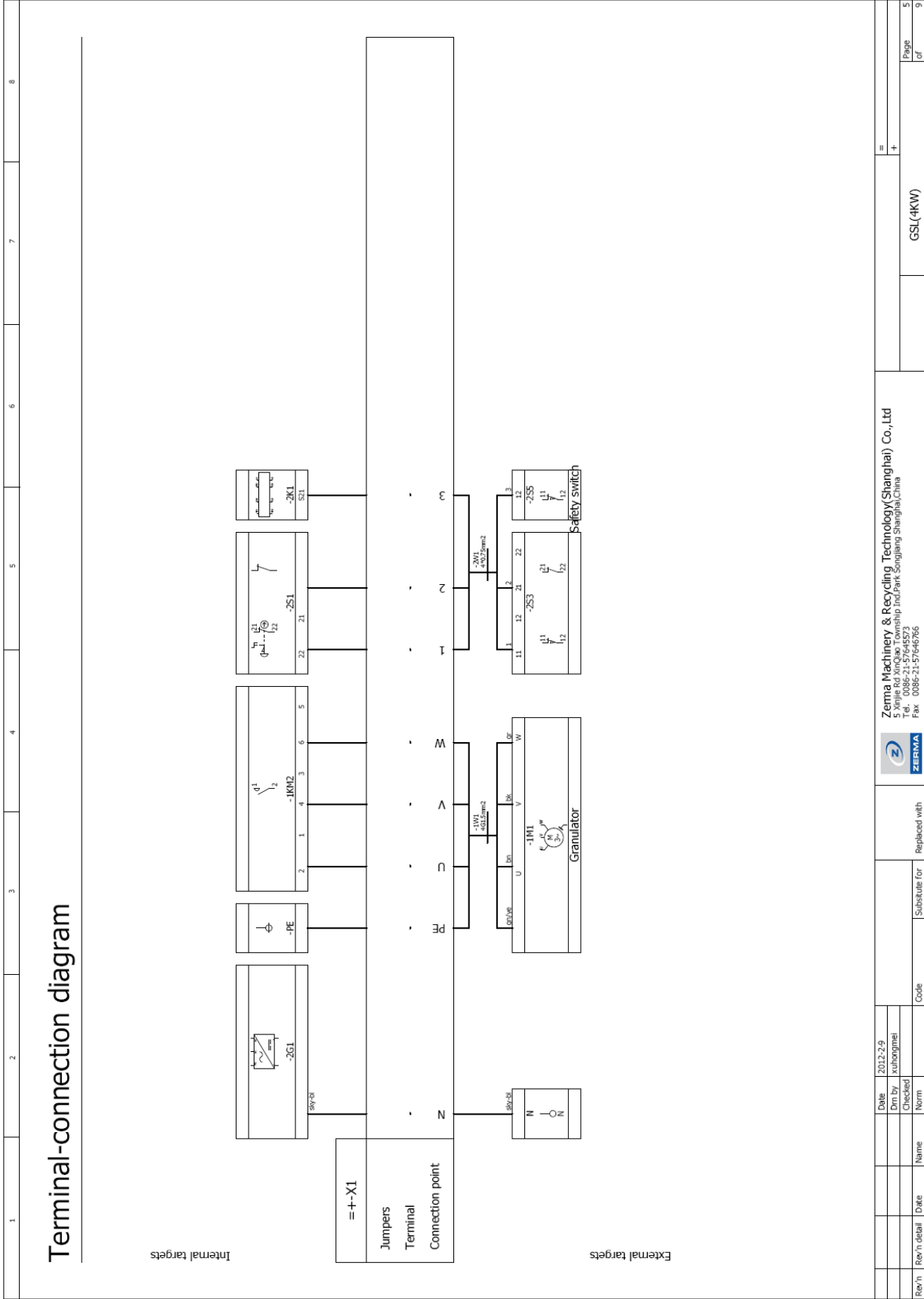

Date	2012-2-9	Replaces with		Code		Page	5
Drawn by	rxiborgmail	Substitute for	Zerma Machinery & Recycling Technology(Shanghai) Co.,Ltd 5 Xiale Rd Xinqiao Township Ind/Park Songjiang Shanghai,China Tel: 0086-21-57646765 Fax: 0086-21-57646765	GSL(4KW)	=	of	9
Checked							
Name							
Revised							

# ORIGINAL INSTRUCTION

## PART A: Basic machine

### Slow speed Granulator A18 Series

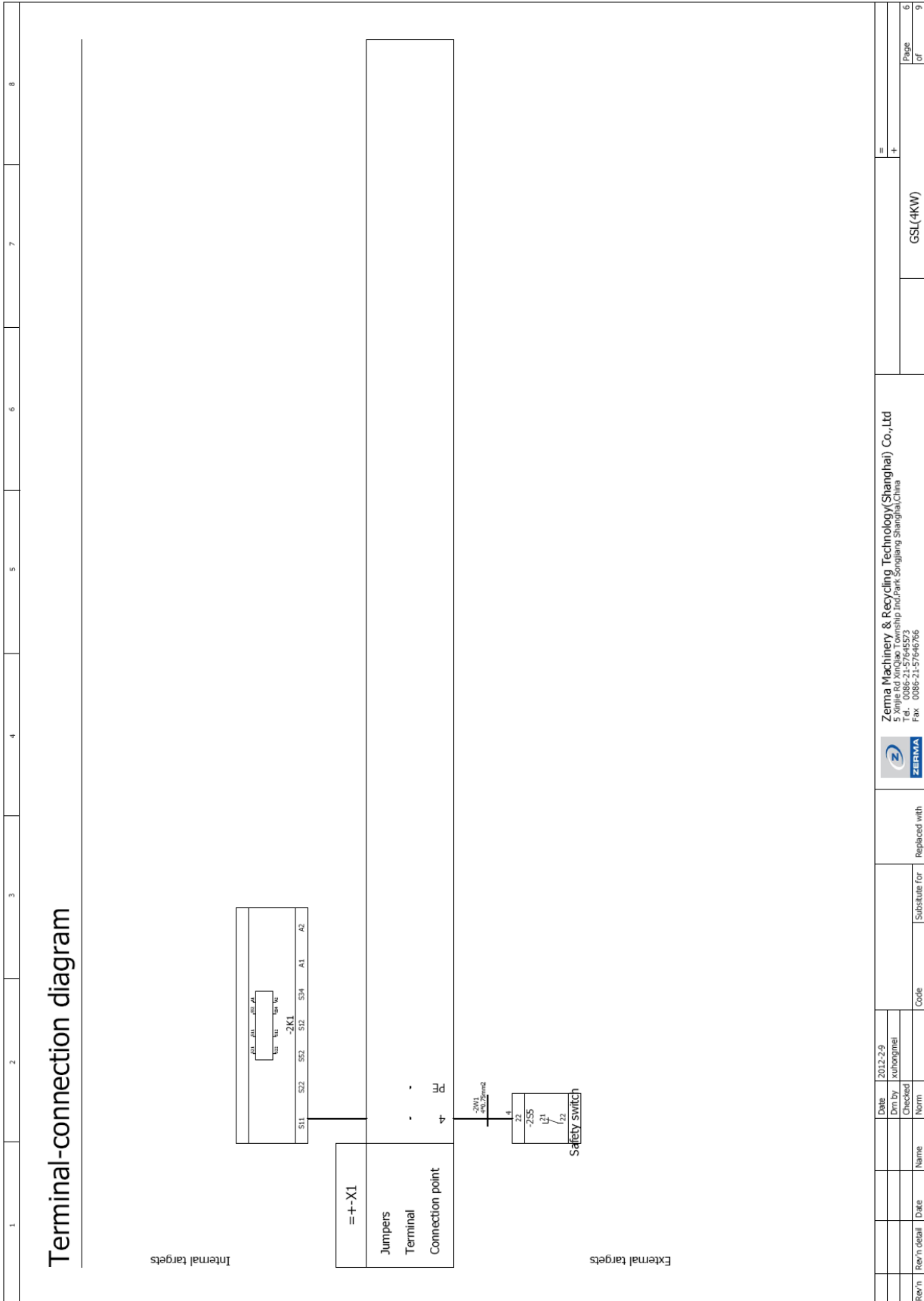

1	2	3	4	5	6	7	8
---	---	---	---	---	---	---	---

Rev'n	Rev'n detail	Date	Name	Norm	Checked	Date	Code	Substitute for	Replaced with	ZERMA	Zerma Machinery & Recycling Technology(Shanghai) Co.,Ltd 5 Xingjie Rd Xinqiao Township Songjiang Ind/Park Songjiang Shanghai,China Tel: 021-57646766 Fax: 0086-21-57646766	GSL(4KW)	Page of
		2012-2-9	Zuozhongmei										6
													9

# ORIGINAL INSTRUCTION

## PART A: Basic machine

### Slow speed Granulator A18 Series

1	2	3	4	5	6	7	8
<b>Summarized parts list</b>							
Material number	Quantity	Component Name	Description	Reference name	Manufacturer		
80007280	1	Control box	AE1035.500 (W*H*D 200*300*155)		RITTAL		
80031186	1	PE busbar	3×17/5 piece		Leipole		
80031372	1	Mould case circuit breaker DC2A	PL9-C2-DC	2F1	Moeller		
80031257	1	Power supply 48W DC24V 2A	CP SNT 48W 24V 2A	2G1	Weidmuller		
80005940	5	Fixing adapter	M22-A	2H1;2S1;3H1;3S1;3S2	Moeller		
80030309	1	Lable	M22-XST	2H1	Moeller		
80030308	1	Lable mount	M22S-ST-X	2H1	Moeller		
80031028	1	Indicator&pushbutton(white)	M22-DL-W	2H1	Moeller		
80005470	3	Contact element NO	M22-K10	2H1;3H1;3S2	Moeller		
80008130	2	Bulb&lamp socket (white/yellow)	M22-LED-W	2H1;3H1	Moeller		
80031027	1	Double actuator	M22-DDL-GR-X1/X0	3H1	Moeller		
80005450	4	Contact element NC	M22-K01	2S1;3H1;3S1	Moeller		
80031269	1	Safety monitoring DC24V	SNA 4043K(DC24V)RL188.1680.0	2K1	Wieland		
80030611	2	Power contactor	DILM9-10CC(24VDC)	1KM1;1KM2	Moeller		
80030725	2	Auxiliary contact module	DILM32C-XH11	1KM1;1KM2	Moeller		
80031043	1	Motor-protective circuit breaker	PKZMC-10	1Q1	Moeller		
80005110	1	Auxiliary contact	NH11-PKZ0	1Q1	Moeller		
80031019	1	Emergency stop actuator	M22-PV	2S1	Moeller		
80030438	3	Safety switch	AZ16-02ZVRK	2S1...2S5	Schmersal		

Date	2012-2-9		
Drawn by	xuorigmel		
Checked			
Norm			
Replaces with			
Substitute for			
Code			
 <b>Zerma Machinery &amp; Recycling Technology(Shanghai) Co.,Ltd</b> 5 Xujie Rd Xinqiao Township Ind.Park Songjiang Shanghai,China Tel: 0086-21-57646766 Fax: 0086-21-57646766			
			GSL(4KW)
			= +
			Page of
			7
			9



**19      ADDITION**

Documentation Gear motor Granulator  
Delivery documentation









**Virtus Equipment**

9120 Centerlinks Commerce Dr., Unit 4  
Fort Myers, FL 33912

239-219-1500

Parts@Virtus-Equipment.com

[www.Virtus-Equipment.com](http://www.Virtus-Equipment.com)