

# OPERATING MANUAL

## C40/60 SERIES

---



---

### **Virtus Equipment**

9120 Centerlinks Commerce Dr., Unit 4  
Fort Myers, FL 33912

239-219-1500  
Parts@Virtus-Equipment.com

[www.Virtus-Equipment.com](http://www.Virtus-Equipment.com)

**Virtus**  
Equipment

The Right Machine for Today's  
Recycling Requirements



**ORIGINAL INSTRUCTION**  
**PART A: Basic machine**  
**Granulator C 40 Series**

---

**Table of Contents**

- 1 Information on this instruction manual \_\_\_\_\_ 6**
- 2 Technical data \_\_\_\_\_ 7**
- 3 General Information \_\_\_\_\_ 9**
  - 3.1 Copyright \_\_\_\_\_ 9**
  - 3.2 Application \_\_\_\_\_ 9**
  - 3.3 Safety \_\_\_\_\_ 9**
  - 3.4 Inspection of goods \_\_\_\_\_ 9**
- 4 General safety advice \_\_\_\_\_ 10**
  - 4.1 Safe operation of the machine \_\_\_\_\_ 10**
  - 4.2 Use in accordance with the regulations \_\_\_\_\_ 11**
  - 4.3 Liability and Responsibility \_\_\_\_\_ 13**
  - 4.4 Structural changes, spare parts, accessories \_\_\_\_\_ 14**
  - 4.5 Operation manuals from other manufacturers \_\_\_\_\_ 14**
  - 4.6 Noise levels and noise control measures \_\_\_\_\_ 15**
  - 4.7 Work stations \_\_\_\_\_ 16**
  - 4.8 Remaining risks \_\_\_\_\_ 16**
    - 4.8.1 Mechanical dangers \_\_\_\_\_ 16
    - 4.8.2 Electrical dangers \_\_\_\_\_ 18
    - 4.8.3 Dangers caused by the control system \_\_\_\_\_ 18
    - 4.8.4 Thermal dangers \_\_\_\_\_ 19
    - 4.8.5 Dangers caused by noise \_\_\_\_\_ 19
    - 4.8.6 Dangers caused by vibration \_\_\_\_\_ 19
    - 4.8.7 Dangers caused by materials and substances \_\_\_\_\_ 20
    - 4.8.8 Danger caused by manipulation of the protective devices \_\_\_\_\_ 20
  - 4.9 Protective devices \_\_\_\_\_ 21**
    - 4.9.1 Safety device for sound enclosure \_\_\_\_\_ 21
    - 4.9.2 "V"-belts, disk flywheels and shaft protector \_\_\_\_\_ 23
    - 4.9.3 Splash guard \_\_\_\_\_ 23
    - 4.9.4 Rotor lock \_\_\_\_\_ 24
    - 4.9.5 Safety markings \_\_\_\_\_ 24
  - 4.10 Authorized persons \_\_\_\_\_ 25**
  - 4.11 Personal protective gear \_\_\_\_\_ 26**
  - 4.12 Safety measures at the application site \_\_\_\_\_ 27**
  - 4.13 Fire fighting agents \_\_\_\_\_ 27**
  - 4.14 Cleaning agents \_\_\_\_\_ 27**
  - 4.15 Conduct in case of an emergency \_\_\_\_\_ 27**
  - 4.16 Classification of specific safety advice \_\_\_\_\_ 28**

**ORIGINAL INSTRUCTION**  
**PART A: Basic machine**  
**Granulator C 40 Series**

---

- 5 Description of the machine** **29**
- 5.1 Grinding material in feed** **29**
  - 5.1.1 In feed hopper 29
  - 5.1.2 Additional in feed device 29
  - 5.1.3 Additional in feed device 30
- 5.2 Base frame/ Soundproof box** **31**
- 5.3 Drive** **32**
- 5.4 Granulator upper section** **33**
- 5.5 Granulator lower section** **34**
  - 5.5.1 Rotor and cutting knives 34
  - 5.5.2 Screen and screen support 35
- 5.6 Opening devices** **36**
  - 5.6.1 Opening controls 37
- 5.7 Discharge of grinding material** **38**
- 5.8 Housing design** **39**
- 6 Initial startup** **40**
- 6.1 General Advice** **40**
- 6.2 Requirements at the application site** **41**
- 6.3 Unloading and installing the machine** **42**
- 6.4 Connections** **43**
  - 6.4.1 Electrical connection 43
  - 6.4.2 Air pressure connection 44
- 6.5 Machine check prior to initial start-up** **45**
- 7 Operation** **46**
- 7.1 Machine checks before switching on the machine** **46**
- 7.2 Switch on machine** **46**
- 7.3 Switch off machine** **47**
- 7.4 Manual in feed of grinding material** **47**
- 8 Maintenance** **48**
- 8.1 Safety advice** **48**
- 8.2 Maintenance plan** **48**
- 8.3 Checking the protective devices** **49**
- 8.4 Open and close the granulator** **50**
  - 8.4.1 Opening the granulator upper section 50
  - 8.4.2 Closing the granulator 51
- 8.5 Replacing the screen** **52**
- 8.6 Cleaning the machine** **53**
- 8.7 Replacing the main bearings** **54**
  - 8.7.1 Dismounting the main bearings 54
  - 8.7.2 Mounting the main bearing 55
- 8.8 Lubricating the main bearings** **56**

**ORIGINAL INSTRUCTION**  
**PART A: Basic machine**  
**Granulator C 40 Series**

---

- 8.8.1 Lubrication intervals: \_\_\_\_\_ 56
- 8.8.2 Check lubricant quality \_\_\_\_\_ 56
- 8.8.3 Replacing or refilling lubricant \_\_\_\_\_ 56
- 8.8.4 List of lubricants \_\_\_\_\_ 58
- 8.9 Mounting and dismounting TAPER-LOCK tensioning element \_\_\_\_\_ 59**
- 8.9.1 Table for the tightening torque of the screws \_\_\_\_\_ 59
- 8.9.2 Mounting the TAPER-LOCK tensioning element \_\_\_\_\_ 60
- 8.9.3 Dismounting the TAPER-LOCK tensioning element \_\_\_\_\_ 60
- 8.10 Work on the "V"-belts \_\_\_\_\_ 61**
- 8.10.1 Checking the tension force of the "V"-belt \_\_\_\_\_ 61
- 8.10.2 Retensioning and relaxing the "V"-belt \_\_\_\_\_ 62
- 8.10.3 Checking "V"-belt condition, replacing "V"-belt \_\_\_\_\_ 62
- 8.11 Working on the cutting knives \_\_\_\_\_ 63**
- 8.11.1 Replacing and checking the cutting knife mountings \_\_\_\_\_ 63
- 8.11.2 Checking the condition of the cutting knives \_\_\_\_\_ 64
- 8.11.3 Dismounting the cutting knives \_\_\_\_\_ 65
- 8.11.4 Mounting the cutting knives \_\_\_\_\_ 66
- 8.11.5 Sharpening cutting knives \_\_\_\_\_ 67
- 8.11.6 Setting the cutting knives \_\_\_\_\_ 70
- 8.11.7 Transporting and storing the cutting knives \_\_\_\_\_ 72
- 9 Troubleshooting \_\_\_\_\_ 73**
- 9.1 Machine blocks or switches itself off \_\_\_\_\_ 73
- 9.2 Rotor does not grip bulky material \_\_\_\_\_ 73
- 9.3 Overheating of the grinding material \_\_\_\_\_ 73
- 9.4 Unusual vibrations \_\_\_\_\_ 74
- 9.5 Extreme cutter wear \_\_\_\_\_ 74
- 9.6 Bearings too hot \_\_\_\_\_ 74
- 9.7 Too many fines in grinding material \_\_\_\_\_ 74
- 9.8 Cutting gap alters during operation \_\_\_\_\_ 74
- 9.9 Screen damage \_\_\_\_\_ 75
- 9.10 Granulator does not start \_\_\_\_\_ 75
- 9.11 Granulator blocks when under load \_\_\_\_\_ 75
- 9.12 Frequent switching off of grinding material in feed device \_\_\_\_\_ 75
- 10 Storage, disposal, transportation \_\_\_\_\_ 76**
- 10.1 Storage \_\_\_\_\_ 76
- 10.2 Disposal \_\_\_\_\_ 76
- 10.3 Transportation \_\_\_\_\_ 76
- 11 Customer service and spare parts orders \_\_\_\_\_ 77**

**ORIGINAL INSTRUCTION**  
**PART A: Basic machine**  
**Granulator C 40 Series**

---

**12 Spare Parts List \_\_\_\_\_ 78**  
**12.1 Spare Parts List C40/60 \_\_\_\_\_ 78**  
**12.2 Spare Parts List C40/100 \_\_\_\_\_ 81**  
**13 Clarification for Personal Training \_\_\_\_\_ 89**  
**14 Electrical Connection \_\_\_\_\_ 90**  
**15 Dimensions Of Standard Machine \_\_\_\_\_ 91**  
**15.1 C40/60 \_\_\_\_\_ 91**  
**15.2 C40/100 \_\_\_\_\_ 92**  
**16 ADDITION \_\_\_\_\_ 93**

## **1 INFORMATION ON THIS INSTRUCTION MANUAL**

Author: VIRTUS EQUIPMENT

No part of this operation manual may be reproduced, distributed or used in any shape or form, stored in a data processing system or translated into another language without written permission.

This operation manual serves to help you to get to know your machine and how to make use of its application possibilities in accordance with the regulations.

The operation manual contains essential information on how to operate the machine safely, correctly and economically. Following this advice will help you to avoid danger, minimize repair costs and down times and to increase the reliability and durability of the machine.

Before you begin to work on and with the machine, please read the operation manual thoroughly. Only after you have read and understood the contents of this operation manual may you begin work on and with the machine. Keep this operation manual at the application site for future reference.

References to chapters, plans and other documents as well as key markings are written in *italics*.

↓ Instructions on handling are marked in this way.

The machine is designed in modular system and offers a wide spectrum of variations to do justice to your expectations. In order that you receive with the delivery of your machine all the information relevant for you, this operation manual is divided into three parts:

1. Part A: Information of the basic machine.
2. Part B: Plans, operation manuals for systems from other manufacturers etc.

Should you wish to order further operation manuals, please quote the machine number.

We wish you every success with your new machine!

**ORIGINAL INSTRUCTION**  
**PART A: Basic machine**  
**Granulator C 40 Series**

---

**2 TECHNICAL DATA**

**C 40/60**

Feed opening	Data in mm:	590x490
Rotor dimension:	Diameter in mm:	400
	Width of cut in mm:	590
Rotor type C3	3-knives-version	
Rotor knives:	Rows of knives:	3
	No. of rotor knives:	6
Stator knives:	No. of bed knives:	2
Rotor speed (50 Hz):	rpm	400
Width:	Data in mm:	1300
Length:	Data in mm:	1250
Height:	Data in mm:	2150
Drive motor:	Power in kW:	15;18.5; 22
Screen:	Type and screen hole size dependent on the application and customer requirements.	
Opening device:	Motor wench	90W
Machine weight:	In kg	2000
Electrical connection data:	markings are attached to the machine	
Noise level: Depends on plant location and type of grinding material!	With noise equipment in dB(A):	< 85
Dimensions:	See Layout <i>drawing</i>	



**ORIGINAL INSTRUCTION**  
**PART A: Basic machine**  
**Granulator C 40 Series**

---

**C 40/100**

Feed opening	Data in mm:	
Rotor dimension:	Diameter in mm: Width of cut in mm:	
Rotor type F3	3-knives-version	
Rotor knives:	Rows of knives:	
	No. of rotor knives:	
Stator knives:	No. of bed knives:	
Rotor speed (50 Hz):	rpm	
Width:	Data in mm:	
Length:	Data in mm:	
Height:	Data in mm:	
Drive motor:	Power in kW:	
Screen:	Type and screen hole size dependent on the application and customer requirements.	
Opening device:	Hydraulic hand pump	
Machine weight:	In kg	
Electrical connection data:	markings are attached to the machine	
Noise level: Depends on plant location and type of grinding material!	With noise equipment in dB(A):	< 85
Dimensions:	See Layout <i>drawing</i>	

### **3 GENERAL INFORMATION**

#### **3.1 Copyright**

VIRTUS Machinery and Recycling Technology (Shanghai) Co. Ltd. holds the copyright for these operation instructions, entrusted to the owner of the granulator for his personal use. These contains technical instructions and drawings which are not be copied complete or in part, distributed or used for reasons of unauthorized competition or for informing others.

#### **3.2 Application**

The granulator is designed for size-reduction of plastic material such as PE, PP, PVC etc. The user is responsible for consequences resulting from incorrect operation: This will lead to the loss of the warranty as well as any compensation claims.

#### **3.3 Safety**

The granulator has been constructed in accordance to the general standards of technology and is fitted with safety devices to prevent accidents that could endanger the life or health of the operator. The company operating the unit is responsible for the compliance of the safety regulations. We recommend staff training courses at regular intervals subsequent to initial training during commissioning.

#### **3.4 Inspection of goods**

The goods must be inspected by the purchaser to ensure that the delivery is complete and free from damage during transport. In the event of any queries VIRTUS must be informed with regard to missing items or transport damage. In the event of actual transport damage, written notification including photographs should be made and sent to the transport company as well as sent to VIRTUS immediately after delivery.

## **4 GENERAL SAFETY ADVICE**

### **4.1 Safe operation of the machine**

The machine is built according to the state of the art and recognised safety regulations.

It is equipped with protective devices; however there is still the threat of danger in case of incorrect conduct or misuse:

- for the health of the operator and that of other persons,
- for the machine,
- for the environment,
- for material assets belonging to the company and the operator.

All persons involved in:

- transportation and storage,
- start-up and shutdown,
- operation,
- setting and fitting
- Maintenance and waste disposal...

of the machine must carefully read and take note of the following advice. However, not only the general safety advice listed in this chapter has to be observed, but also the safety advice which is added specifically in the other chapters.

Failure to heed this safety advice can lead to loss of all compensation claims.

Furthermore, the existing rules and regulations for the prevention of accidents as well as in house company working, operational and safety regulations have to be observed.

## **4.2 Use in accordance with the regulations**

The operational safety of the delivered machine is only guaranteed for use in accordance with the regulations!

This regulation use is only achieved if the following points are observed and fulfilled.

### **Manufacturing process and grinding material**

The granulator is suitable exclusively for the grinding of material, which corresponds to the agreed customer-specific specifications in all points (see *Contract of sale*).

Any other work or design will differ from the specified requirements. VIRTUS EQUIPMENT will not be held responsible. The specified requirements also include all information found in the owner's manual such as maintenance and service. Any change in the specifications or requirements must be brought to the attention of VIRTUS .

### **Suction unit**

If emissions occur during grinding of material, which exceed the permissible legal values for contaminants in the air, the granulator may only then be operated when the customer on site has installed a suitable air suction device.

### **Safety device for the roller feeder**

The operational safety of the roller feeder is only guaranteed for use in accordance with the regulations! This regulation use of the roller feeder is the in feed of plastic foil strips and foil widths which correspond to the agreed customer-specific specifications in all points (see *Contract of sale*).

### **Known uses not in accordance with the regulations**

Never put grinding material into the in feed which does not correspond to the agreed customer-specific specifications. If this occurs, there is a danger to persons and the possibility of damage to the nip roll feed device and the successive units.

### **Connection of the Emergency Stop button**

The machine may only be operated with the installed Emergency Stop buttons. In case no Emergency Stop buttons have been installed, an Emergency Stop button must be mounted on the control cabinet, the second on the material in feed.

# ORIGINAL INSTRUCTION

## PART A: Basic machine

### Granulator C 40 Series

---

#### **Miscellaneous:**

- The working conditions and instructions specified in this operation manual must be adhered to.
- The machine is not suitable for operation in an explosive environment.
- Faults, which can impair safety, are to be reported immediately and eliminated by a trained and skilled specialist.
- The machine may only be used in the industrial application range.
- The nip roll feed device is not suitable for operation in an explosive environment.
- The nip roll feed device may only be used in the industrial application range.

#### **General Requirements Safety Information**

- The service and maintenance in this owner's manual must be performed on a regular basis.
- The machine is not designed for operation in a volatile environment.
- Faults that could be a safety factor must be reported immediately and repaired by experienced personal.
- The machine must only be installed in a production type building.

#### **Known uses not in accordance with the regulations**

Never grind grinding materials, which do not correspond to the agreed customer-specific specifications. If this occurs, there is a danger to persons and the possibility of the machine being damaged.

#### **Informal Safety Requirements**

The owner's manual should always be located near the machine. New excerpts or additions to the owners' manual must always be replaced to include any safety requirements or environmental requirements.

All safety or caution signs must be visual and easy to read.

### **4.3 Liability and Responsibility**

The General Conditions of Sale and Delivery basically apply. These conditions apply no later than the end of the contract. Liability and or responsibility to seller do not apply to the following;

- Equipment is not properly used for its specific application.
- Non-conforming installation, commissioning or service of the machines.
- Operation of the equipment without proper safety guards.
- Not conforming to the directions of the owners' manual regarding transport, storage, installation, commissioning or servicing the equipment.
- Any designs alterations on the machine.
- Any changes on the program logic which can alter the machine operation or electrical function.
- Changes in the logic function.
- In proper maintenance or serving the machines that can lead to extraordinary wear
- In proper serving of equipment
- Spontaneous crashes caused by foreign objects falling into the machine or acts of God

We honour a 12 month guarantee valid after delivery under the conditions that originally delivery or original parts from VIRTUS EQUIPMENT are used or accepted for use in accordance with our owner's manual.

Otherwise the guarantee will be considered invalid. Excluded are wear and tear parts such as knives, screens, drive belts, bearings, etc.

#### **4.4 Structural changes, spare parts, accessories**

For reasons of safety, remodelling and modifications to the machine, in particular to the electrical devices, are only permissible by arrangement with the manufacturer!

Replace faulty parts immediately. Only use original spare parts or spare parts from other manufacturers, which correspond, to the original spare parts with regards to function, stress and safety. This applies in particular for reasons of EMC (electro-magnetic compatibility) for electrical components.

The use of unsuitable parts can impair resistance to rays and increase the emission of rays!

If parts are replaced which are relevant for safety, they must be checked afterwards for proper functioning.

Only use accessories, which have been approved by the manufacturer. Use of accessories can change work with the machine. You must therefore observe the additional advice for your work and your safety. Read *Part B: Accessories*, before you commission the machine.

#### **4.5 Operation manuals from other manufacturers**

Integrated in the machine are systems from other manufacturers. When working on or with these systems, please observe the advice in the operation manuals from the respective manufacturer. These operation manuals are enclosed with the machine documentation.

**ORIGINAL INSTRUCTION**  
**PART A: Basic machine**  
**Granulator C 40 Series**

---

**4.6 Noise levels and noise control measures**

The noise level of the granulator at idle speed is approximately 75-83 dB(A).

In order not to exceed the noise level of 85 dB(A) is the purchaser required to provide additional soundproofing measures.

The noise level can be affected by foundation static or dynamic, aux. blowers etc. or other additional equipment. Therefore it is necessary to actually determine if the noise level is directly coming from the machine or accessory equipment.

VIRTUS EQUIPMENT offers the following equipment to reduce the noise levels:

Illustration:  
Granulator  
type C with soundproof  
box and soundproof  
hopper.



**CAUTION**

The user or purchaser is responsible for compliance with the instructions and procedures!



**ORIGINAL INSTRUCTION**  
**PART A: Basic machine**  
**Granulator C 40 Series**

---

**4.7 Work stations**

During normal operation, the work station is the station at the in feed of the grinding material.

For maintenance work, the whole area around the nip roll feed device is at your disposal.

**4.8 Remaining risks**

The machine is constructed so that you are able to operate it safely. Structurally non-avoidable dangers are prevented as well as possible by the protective devices. A certain remaining risk does however always remain! Being aware of these remaining risks of the machine will help you to structure your work more safely and in so doing to avoid accidents.

To avoid danger, please observe in addition the specific safety advice in the individual chapters.

**4.8.1 Mechanical dangers**

<b>Type of danger:</b>	Danger of crushing by heavy parts falling down or falling over.
<b>Activity:</b>	Unloading and transporting the machine or machine components.
<b>Possible consequences:</b>	Serious injury could result.
<b>Preventative measures:</b>	Wear personal protective gear. Follow the instructions in this <i>Operation manual</i> .

<b>Type of danger:</b>	Danger of cutting caused by sharp cutting knives, even when the rotor is stationary.
<b>Activity:</b>	Knife replacement, knife setting, and knife sharpening, other maintenance work.
<b>Possible consequences:</b>	Serious injury, particularly to hands and fingers can result.
<b>Preventative measures:</b>	Wear personal protective gear. Follow the instructions in this <i>Operation manual</i> .

**ORIGINAL INSTRUCTION**  
**PART A: Basic machine**  
**Granulator C 40 Series**

---

<b>Type of danger:</b>	Danger of crushing when closing the granulator upper section.
<b>Activity:</b>	Maintenance work.
<b>Possible consequences:</b>	Serious injury can result.
<b>Preventative measures:</b>	When closing the granulator upper section, ensure that no persons are in the danger area.

<b>Type of danger:</b>	Tripping over cables and other objects lying around.
<b>Activity:</b>	All activities.
<b>Possible consequences:</b>	Serious injury can result.
<b>Preventative measures:</b>	Lay cables in accordance with the regulations. Keep work station clean and tidy.

<b>Type of danger:</b>	Danger of crushing, cutting and amputation caused by up to 3 minute run down of the rotor.
<b>Activity:</b>	Maintenance work.
<b>Possible consequences:</b>	Serious injury or death can result.
<b>Preventative measures:</b>	The housing upper section must always be tightly locked during operation using the connecting screws. Do not make the run down safety devices ineffective by using technical aids or other manipulations. Never check by hand whether the rotor has come to a stop.

<b>Type of danger:</b>	Danger of pulling in caused by running "V"-belts.
<b>Activity:</b>	All activities.
<b>Possible consequences:</b>	Hair, jewellery etc. can be pulled into the machine. Serious injury can result.
<b>Preventative measures:</b>	Never dismount "V"-belt protection or soundproofed covers.

**ORIGINAL INSTRUCTION**  
**PART A: Basic machine**  
**Granulator C 40 Series**

---

**4.8.2 Electrical dangers**

<b>Danger:</b>	Direct or indirect contact with live parts in the terminal box.
<b>Activity:</b>	Maintenance work, start-up.
<b>Possible consequences:</b>	Serious injury or death.
<b>Preventative measures:</b>	<p>Trained electricians may only carry out all work on the electrical equipment.</p> <p>If work is necessary on parts, which conduct dangerous voltage, a second person should be called in who can break the power supply in case of emergency.</p> <p>The yellow-marked lines conduct voltage even when the machine is switched off (main switch to 0).</p> <p>Only use original safety fuses with stipulated intensity of current.</p> <p>Faulty electrical components must be replaced immediately.</p> <p>If faults occur in the electrical energy supply, switch machine off immediately.</p> <p>The terminal box must be locked during operation. Before opening the terminal box: Main switch to 0.</p>

**4.8.3 Dangers caused by the control system**

<b>Type of danger:</b>	Danger caused by failure of the Emergency Stop function.
<b>Activity:</b>	All activities.
<b>Possible consequences:</b>	Serious injury or death.
<b>Preventative measures:</b>	It must be guaranteed that failure of an Emergency Stop button is displayed and leads to an immediate stop of the machine.

**ORIGINAL INSTRUCTION**  
**PART A: Basic machine**  
**Granulator C 40 Series**

---

**4.8.4 Thermal dangers**

<b>Type of danger:</b>	Danger of fire and explosion caused by throwing dangerous objects (e.g. spray cans) into the granulator.
<b>Activity:</b>	Grinding.
<b>Possible consequences:</b>	Serious injury or death can result.
<b>Preventative measures:</b>	Only grind grinding material, which corresponds to the agreed customer-specific specifications in all points.

**4.8.5 Dangers caused by noise**

<b>Type of danger:</b>	Damage to hearing.
<b>Activity:</b>	All activities.
<b>Possible consequences:</b>	Diminished hearing, headaches, impaired balance, and deterioration of concentration.
<b>Preventative measures:</b>	Reduce noise emissions by taking suitable measures. Wear ear protection.

**4.8.6 Dangers caused by vibration**

<b>Type of danger:</b>	Instability of the granulator caused by vibration.
<b>Activity:</b>	All activities.
<b>Possible consequences:</b>	Serious injury can result.
<b>Preventative measures:</b>	Install the machine according to the instructions of this <i>Operation manual</i> and the <i>Assembly drawing</i> .

<b>Type of danger:</b>	Loosening of the cutting knife mountings caused by vibration.
<b>Activity:</b>	All activities.
<b>Possible consequences:</b>	Serious injury can result.
<b>Preventative measures:</b>	Check the cutting knife mountings regularly according to the instructions in this operation manual.

**ORIGINAL INSTRUCTION**  
**PART A: Basic machine**  
**Granulator C 40 Series**

---

**4.8.7 Dangers caused by materials and substances**

<b>Type of danger:</b>	Inhalation of grinding dust.
<b>Activity:</b>	All activities.
<b>Possible consequences:</b>	Diseases of the respiratory tract etc.
<b>Preventative measures:</b>	Mount a suitable air suction device. Wear breathing equipment if necessary. When cleaning the machine do not blow out grinding dust, use suction instead.

**4.8.8 Danger caused by manipulation of the protective devices**

<b>Type of danger:</b>	Danger of crushing, cutting and amputation.
<b>Activity:</b>	All activities.
<b>Possible consequences:</b>	Serious injury or death can result.
<b>Preventative measures:</b>	Never make the protective devices ineffective. Check the protective devices regularly for proper functioning according to the specifications given in this operation manual.

# ORIGINAL INSTRUCTION

## PART A: Basic machine

### Granulator C 40 Series

---

#### 4.9 Protective devices

The machine may under no circumstances be operated without these protective devices or with faulty or manipulated protective devices.

Dismounting of protective devices may only be carried out when all parts are at a standstill, the power supply is disconnected and the main switch is safeguarded using a padlock.

If the protective devices have been dismantled, the machine may only be started up again when all protective devices have been mounted and checked for proper functioning.

##### 4.9.1 Safety device for sound enclosure

Illustration:  
Safety device  
for housing door



The granulator can only be operated if the sound enclosure is closed.

The safety switch for the front door has a guard locking and can be only opened after the key switch “Door Open” at the panel is activated. The electrical time delay prevents that the machine can be opened before the machine comes to shutdown..

**ORIGINAL INSTRUCTION**  
**PART A: Basic machine**  
**Granulator C 40 Series**

---

Illustration:  
C 40/60  
Front door opened



Illustration:  
Back door opened



# ORIGINAL INSTRUCTION

## PART A: Basic machine

### Granulator C 40 Series

---

#### 4.9.2 "V"-belts, disk flywheels and shaft protector

Due to the fact that the granulator has a soundproof box surrounding it, the V-belts, disk flywheel and shafts cannot be accessed without opening the soundproof box. They have no special protectors

#### 4.9.3 Splash guard

In case that the grinding material is introduced directly via the in feed hopper, the input opening is provided with a splash guard.

Illustration:  
Hopper splash guards



#### **Attention:**

Fixation of the splash guard curtains must be checked from time to time.



# ORIGINAL INSTRUCTION

## PART A: Basic machine

### Granulator C 40 Series

---

#### 4.9.4 Rotor look

Illustration:  
Rotor Look

- (1) Interlock
- (2) Looking disc inside the pulley cover

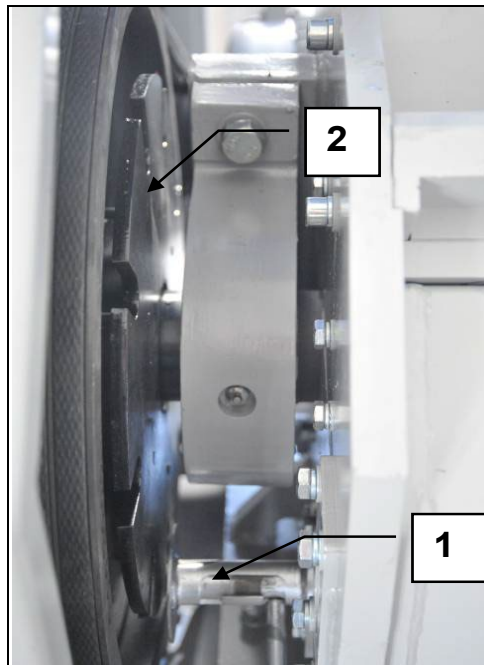

To secure the rotor against turning by knife change or other maintenance work, move the security interlock into the looking disc, which is mounted to the pulley.

#### 4.9.5 Safety markings

Safety markings are attached to the machine. If one of these markings becomes detached or is no longer recognisable, it must be replaced.

**ORIGINAL INSTRUCTION**  
**PART A: Basic machine**  
**Granulator C 40 Series**

---

**4.10 Authorized persons**

Authorized personnel may only carry out work on the machine. Observe the legally permissible minimum age!

As a basic rule, persons who have received training on the machine may only operate the machine.

Personnel, who are still to be trained or receive instruction on the machine, may only work on the machine under constant supervision by an experienced person.

The company operating the machine must make the operation manual accessible to the machine user and ensure that he has read and understood it. Only then may he put the machine into operation.

Responsibility for the different jobs on the machine must be clearly established and adhered to. There must be no unclear areas of authority, as this could endanger the safety of the machine user.

If several persons work on the machine, a detailed division of workstations should be set up.

Trained electricians may only carry out all work on the electrical equipment.

Authorized specialist personnel may only eliminate faults on the control system.

All work related to installation, trained specialist personnel having received instruction on the machine might only carry out fittings and maintenance of the machine.

The operator must make sure that only authorized person's work on the machine. He is responsible for the safety of third persons in the working area of the machine.

**ORIGINAL INSTRUCTION**  
**PART A: Basic machine**  
**Granulator C 40 Series**

---

**4.11 Personal protective gear**

Wear close-fitting clothing. Jewellery and hair must be worn so that they cannot be pulled into the machine by moving parts.

**The following protective gear must be worn when carrying out the following tasks:**

	<b>Safety helmet</b>	<b>Safety boots</b>	<b>Safety gloves</b>	<b>Safety goggles</b>	<b>Ear muffs</b>
Unloading machine.	x	x	x		
Connecting machine.		x			
Operation.		x	x	x	x
Cleaning.		x	x	x	
Maintenance of bearings.		x			
Screen replacement.		x	x		
Maintenance of "V"-belts.		x			
Maintenance of cutting knives.		x	x		
Knife sharpening.		x	x	x	x

If necessary, protect yourself (in addition to the air suction device) with breathing equipment before inhaling substances harmful to the health.

#### **4.12 Safety measures at the application site**

Requirements at the application site: see chapter *Initial Start-up*.  
The machine must be erected horizontally on a horizontal surface and in a stable manner.  
Ensure by means of appropriate in house orders and controls that the environment of the work station is always clean and clear of obstructions.

#### **4.13 Fire fighting agents**

In the case of fire, disconnect the power supply of the machine or pull out the mains plug. Extinguish the fire from a distance of several meters using a fire extinguisher suitable for the machine and the grinding material.

#### **4.14 Cleaning agents**

Only use suitable cleaning agents to clean the machine and in doing so, the advice of the manufacturer is to be heeded. Please be aware that unsuitable cleaning agents (e.g. thinners) can damage the paint of the machine as well as the cables and plastic parts.

#### **4.15 Conduct in case of an emergency**

The machine may only be operated with the installed Emergency Stop buttons. An Emergency Stop button must be mounted onto the control cabinet, the second onto the grinding material in feed.

##### **Emergency Stop:**

- ↓ In case of emergency, immediately press one of the *Emergency Stop buttons*.



## **CAUTION**



**The EMERGENCY STOP must be activated in all situations whereby injury or damage could result!**



##### **Reoperation:**



- ↓ Eliminate cause of Emergency Stop.
- ↓ Unlock *EMERGENCY STOP BUTTON*.
- ↓ Acknowledge fault.  
The machine is now ready for operation again.

#### 4.16 Classification of specific safety advice

The specific safety advices in the following chapters of this operation manual are classified as follows:

 <b>DANGER</b>	
	Indicates an immediately threatening danger. If you do not take avoiding action, death or serious injury will result.

 <b>WARNING</b>	
	Indicates a possibly dangerous situation. If you do not take avoiding action, death or serious injury could result.

 <b>CAUTION</b>	
	Indicates a possibly dangerous situation. If you do not take avoiding action, slight or minor injury could result.

This safety advice refers to the remaining risks for certain working steps and helps you to work safely with the machine. In addition to the safety advice above, there are also the hint and the tip.

### **HINT**



Indicates a possibly harmful situation. If you do not take avoiding action, the machine could be damaged.

### **TIP**



Indicates application tips and other particularly useful information.

## **5 DESCRIPTION OF THE MACHINE**

### **5.1 Grinding material in feed**

The grinding material can be fed into the granulator in the following ways:

- Manual in feed of the grinding material directly into the in feed hopper.
- Automatic in feed of the grinding material by means of an additional in feed device (e.g. conveyor belt).

#### **5.1.1 In feed hopper**

The grinding material in feed ensues via an in feed hopper, which is formed so that the grinding material can be delivered correctly and safely. A splashguard at the input opening prevents thrown-back parts being able to escape. The grinding material in feed can take place manually or with the help of an additional in feed device.

Illustration:

- (1) Infeed hopper  
(2) Machine







#### **5.1.2 Additional in feed device**

If your machine has an optional in feed device such as roller feeder or conveyor belt please refer to the additional information about the accessories in the appendix.

**ORIGINAL INSTRUCTION**  
**PART A: Basic machine**  
**Granulator C 40 Series**

---

 <b>DANGER</b>	
	<p><b>Material fly back can occur out of the hopper opening. Serious injury or death can result.</b> <b>Do not remove the splash guards from hopper or throw in material larger than the hoppers capacity</b> <b>Splash guards has to be closed during grinding</b></p>

 <b>WARNING</b>	
	<p><b>If using a hopper with side infeed or pipe hopper:</b> <b>The material shall be shorter than 80% of the side arms length!</b></p>

**5.1.3 Additional in feed device**

If your machine has an optional in feed device such as roller feeder or conveyor belt please refer to the additional information about the accessories in the appendix.

# ORIGINAL INSTRUCTION

## PART A: Basic machine

### Granulator C 40 Series

---

#### 5.2 Base frame/ soundproof box

The C Series of VIRTUS is especially designed for in line recycling inside the production area. For this purpose our main focus was to provide a machine, which is compact in its dimensions as well as soundproofed to meet the requirements of different workplace regulations.

Illustration:

- (1) Base frame
- (2) Soundproof box

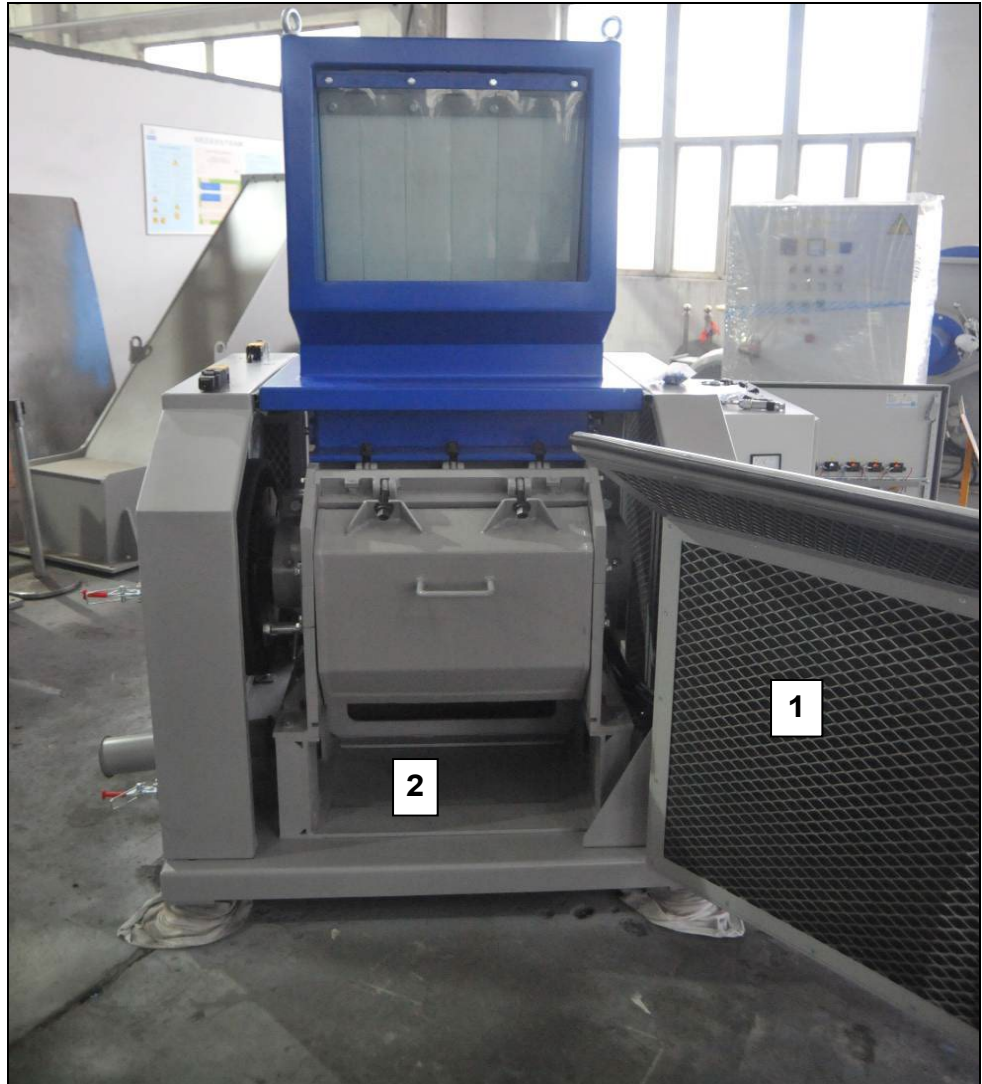

The granulator, the suction bin, the drive motor, the opening device and the terminal box, for the electrical connections, are mounted on the base frame.

The base frame is equipped with a sufficient number of vibration and noise muffling mounting pads.

The soundproof box is also mounted on the base frame.



**ORIGINAL INSTRUCTION**  
**PART A: Basic machine**  
**Granulator C 40 Series**

---

**5.3 Drive**

The drive of the rotor ensues by means of an electric motor via "V"-belts. The motor, which is mounted on sliding rails or a motor plate, can be adjusted for regulating the tension of the "V"-belts by means of tensioning screws. The "V"-belt pulley is attached with a special tensioning element to the motor shaft.

Illustration:  
V-Belt-Drive

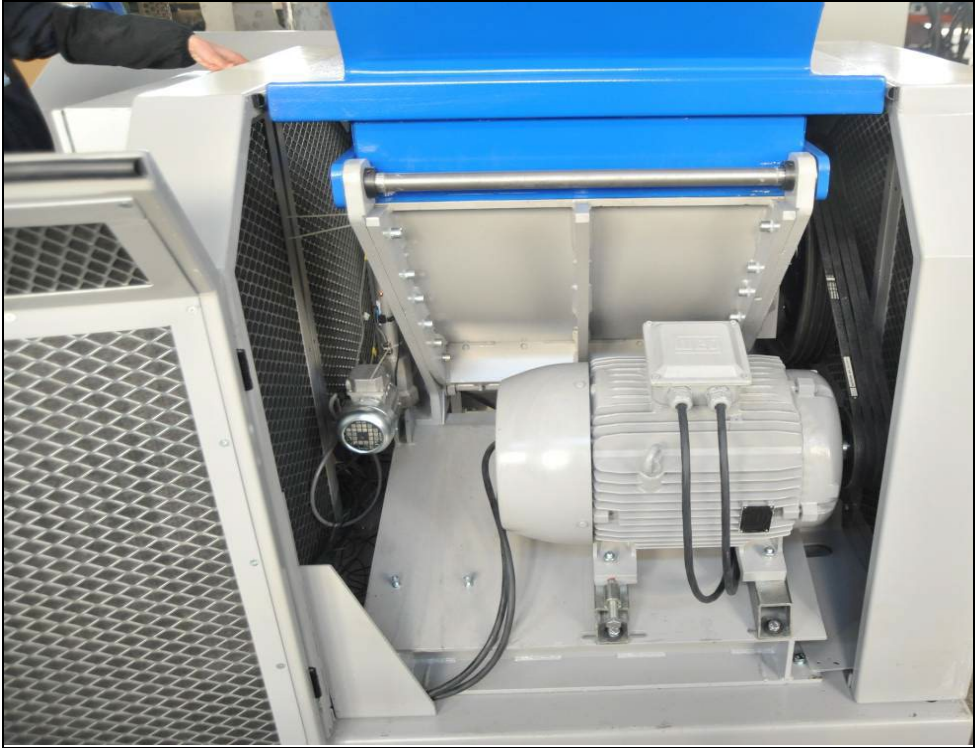

Please observe the operation manual from the manufacturer!

**ORIGINAL INSTRUCTION**  
**PART A: Basic machine**  
**Granulator C 40 Series**



---

**5.4 Granulator upper section**

The hopper can be opened by the mounted electric jack for maintenance work and for cleaning. It is connected with the granulator lower section by means of a joint.

Illustration:  
Granulator upper section  
(opened)



 <b>CAUTION</b>	
	<p><b>Front and back door and hopper can only be opened after key switch “DOOR OPEN” has been activated.</b> <b>Before restart the machine Key switch “DOOR OPEN” need to be deactivated.</b></p>

# ORIGINAL INSTRUCTION

## PART A: Basic machine

### Granulator C 40 Series

---

#### 5.5 Granulator lower section

The granulator lower section and the drive are mounted onto the base frame. The rotor is arranged on bearings in the granulator lower section. The bearings lie outside the grinding chamber and are sufficiently sealed off against penetrating dirt. The bed knives which are installed in the granulator lower section are easily accessible and simple to install and dismantle. The ground material falls through a screen into the suction trough mounted underneath the rotor.

##### 5.5.1 Rotor and cutting knives

Illustration:

- (1) Stator knives
- (2) Rotor knives

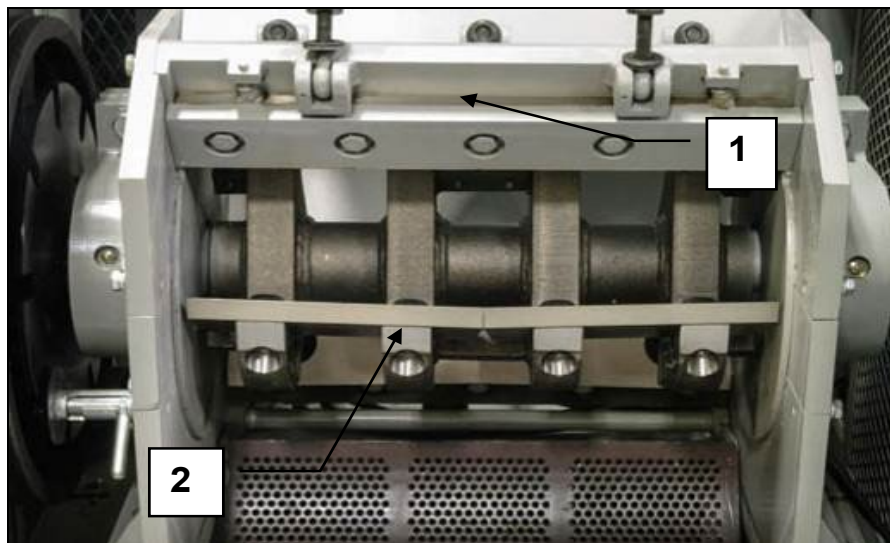

The material is ground between the knives assembled on the rotor and the stator knives which are mounted in a fixed position in the housing.

All rotors are equipped with either a single or a v-shaped scissor cut to decrease the power consumption and to increase the capacity of the machine, while avoiding high amp-peaks.

The design of the rotor has a significant influence on the quality of the grinding process and its results. The rotor construction, the type of knife mounting and the number of knives have all been exactly matched to your task allocation.

The rotor is arranged on roller bearings, which are situated outside the housing. The "V"-belt pulley is attached by means of a taper bush to the rotor axis. The rotor is dynamically counter balanced and has vibration-free concentricity. The rotor is accessible after opening the granulator upper section.

**ORIGINAL INSTRUCTION**  
**PART A: Basic machine**  
**Granulator C 40 Series**

**5.5.2 Screen and screen support**

The screen lies in the supporting screen support in the granulator lower section. This screen support is arranged on bearings which can be pivoted and screwed into the working position with the granulator lower section.

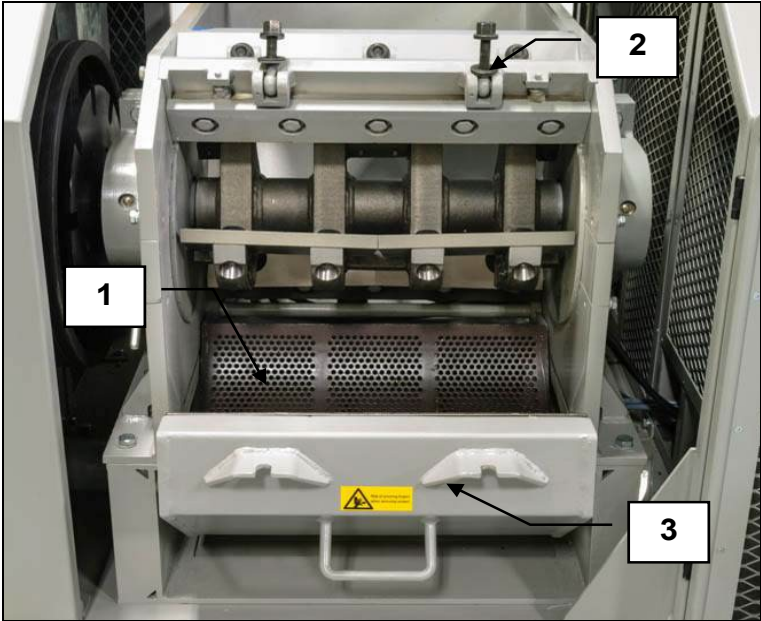

Illustration:

- (1) Screen
- (2) Screws for screen support
- (3) Screen support



The screen is slightly larger in its radius than the cutting circle of the rotor knife. The screen perforation is selected according to the desired grain size of the grinding material.

All grinding material parts which are smaller than the screen perforation fall through the screen into the suction trough. The screen is replaceable and can be taken out after the suction trough is taken out and the screen holder is lowered.

 <b>CAUTION</b>	
	<p><b>Front door and hopper can only be opened after key switch “DOOR OPEN” has been activated. Before restart the machine Key switch “DOOR OPEN” need to be deactivated.</b></p>

**ORIGINAL INSTRUCTION**  
**PART A: Basic machine**  
**Granulator C 40 Series**

---

**5.6 Opening devices**

The granulator upper and the screen support section are opened and closed for maintenance work and cleaning. The housing opening is using an electric jack; the screen is opening manually by lowering the complete screen support

Illustration:

(1) Electric Jack

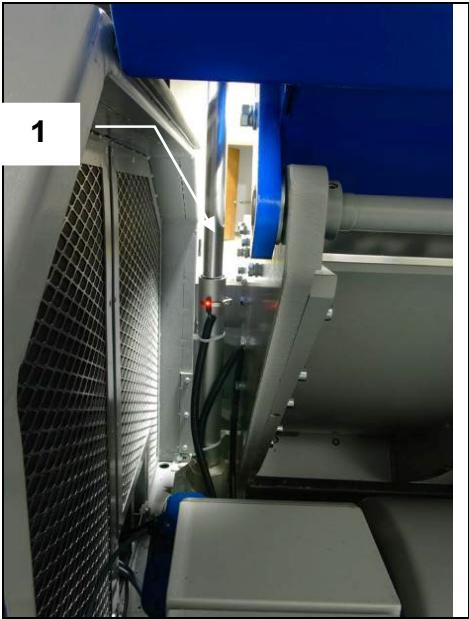
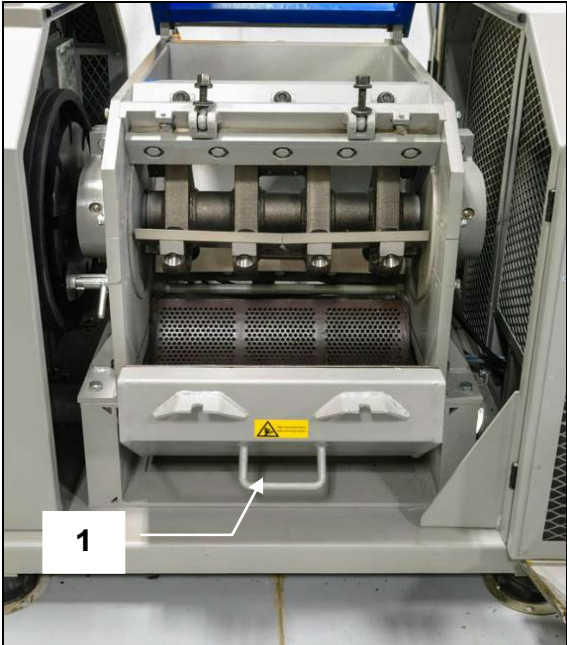

Illustration:

(1) Handle for screen support





**ORIGINAL INSTRUCTION**  
**PART A: Basic machine**  
**Granulator C 40 Series**

**5.6.1 Opening controls**

Illustration:

- (1) Selector switch MAINTENANCE
- (2) Selector switch OPEN/CLOSE

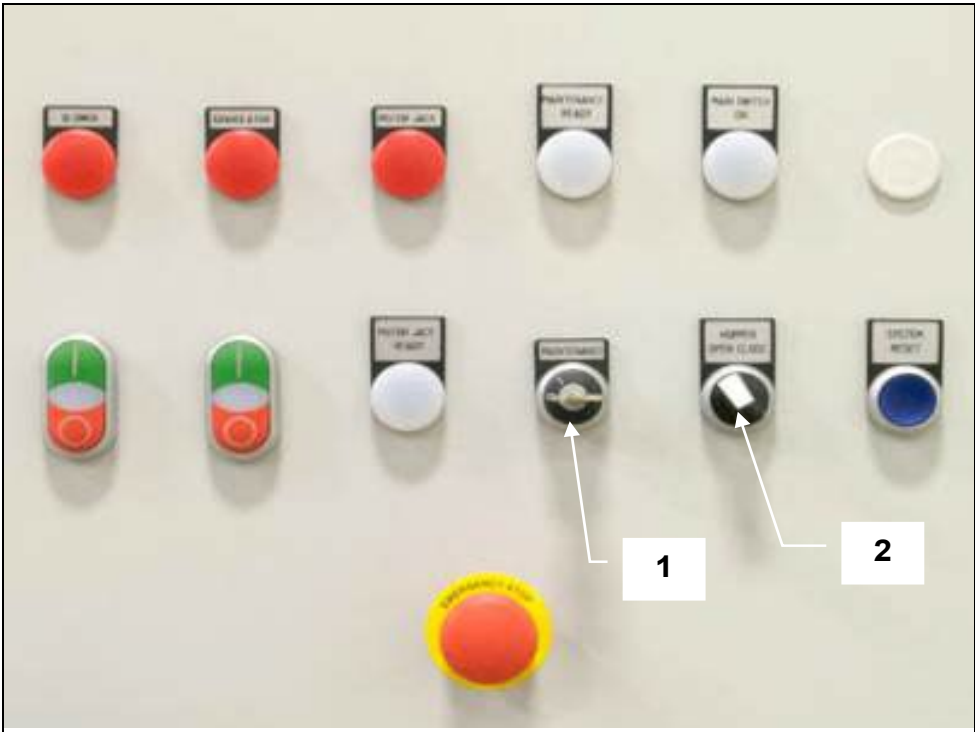
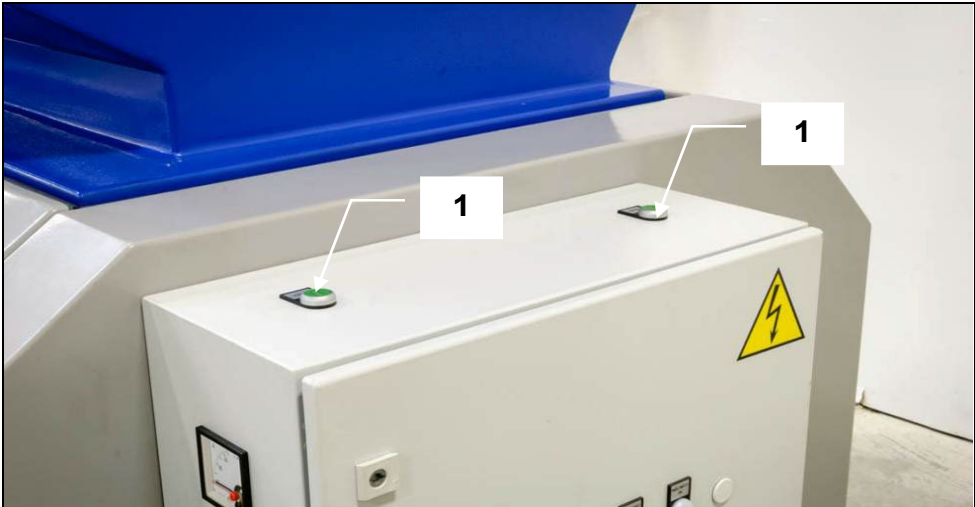

Illustration:

- (1) 2 Hand switch button for Starting the jack



The electric jack unit is set ready for operation after activating the selector switch “MAINTENANCE”. Next to the switch “MAINTENANCE” is the selector switch “OPEN/CLOSE” the hopper. On the control panel top there are 2-hand buttons for starring the jack.

# ORIGINAL INSTRUCTION

## PART A: Basic machine

### Granulator C 40 Series

---

#### 5.7 Discharge of grinding material

Illustration:

Blower

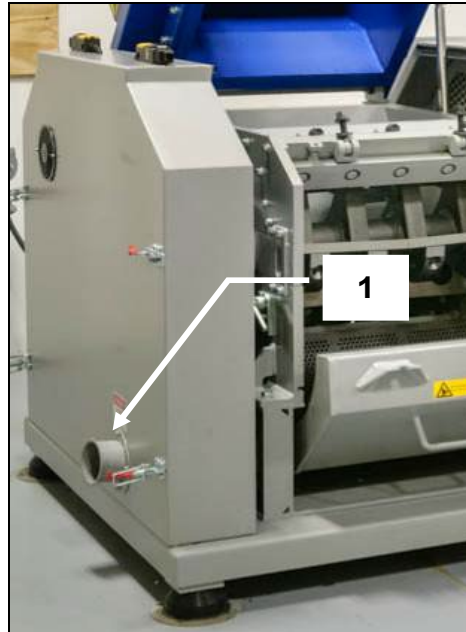



The ground material is sucked off by means of a blower out of the suction trough of the granulator. During this process, air is sucked through the in feed hopper of the granulator and drawn through the grinding chamber. At the same time, the grinding chamber and the grinding material are cooled. In addition, a partial air current is sucked in through the by-pass flap which is located on the suction trough. This air current can be regulated with the help of an air regulating flap mounted here. The blower located next to the sound proof box.

**ORIGINAL INSTRUCTION**  
**PART A: Basic machine**  
**Granulator C 40 Series**

---

**5.8 Housing design**

The housing is specially designed for the recycling of light and bulky parts, such as blow moulding rejects or big sprues and rejects in the injection moulding production. To ensure that these bulky parts are ground properly the machine has an extreme tangential in feed combined with top mounted rotor blades

 <b>DANGER!</b>	
	<p><b>Those two designing factors on the other hand make the granulator very sensitive in means of mishandling the machine as over feeding or feeding of oversized or high impact strengthen parts that can cause serious damages to the granulator as well as to the operator!</b></p>



## **6 INITIAL STARTUP**

### **6.1 General Advice**

**All work related to start-up may only be carried out by trained specialist personnel.**

**Check the machine for possible transportation damage or other damage. Should you determine damage, have this confirmed by the freight company and please report this to us in writing immediately after delivery. When starting up for the first time and after setting up ready for service, you must carry out the necessary checks according to the chapter *Machine check prior to initial.***

## **6.2 Requirements at the application site**

The site of application for the machine must exhibit the following features:



- Enclosed space.
- The ground must exhibit sufficient load-bearing capacity (you can find the machine weight in the *Chapter Technical Data*). The unevenness of the ground surface may not exceed 5 mm.
- The machine must be freely accessible from all sides.
- There must be sufficient room available for operating and service personnel.
- Spatial requirements: see *Assembly drawing*. All hinged parts must be able to be opened completely.
- Vibration-free environment.
- The application site must be well-lit.
- The machine may not be exposed to direct radiation caused by radiators or the sun.
- Room temperature: +5° to +40°C
- Relative atmospheric humidity according to DIN 40040:  
15 to 70 % (indoor)  
By humidity levels higher than 70 %, apply anticorrosive agent to the metallic-finished machine parts. Insulation for the tropics is also necessary.
- The machine may not be operated within range of static discharges or strong magnetic fields as this could lead to faults in the machine control system.
- The nip roll feed device must be freely accessible from all sides.
- There must be sufficient room available for operating and service personnel.
- Spatial requirements
- Vibration-free environment.
- The application site must be well-lit.
- The roller feeder may not be exposed to direct radiation caused by radiators or the sun.
- Room temperature: +5° to +40°C
- Relative atmospheric humidity according to DIN 40040:  
15 to 70 % (indoor), no dewing.  
By humidity levels higher than 70 %, apply anticorrosive agent to the metallic-finished parts. Insulation for the tropics is also necessary.
- The nip roll feed device may not be operated within range of static discharges or strong magnetic fields as this could lead to faults in the control system.

**ORIGINAL INSTRUCTION**  
**PART A: Basic machine**  
**Granulator C 40 Series**

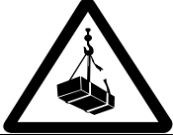

---

**6.3 Unloading and installing the machine**

The machine or the machine components are packed so that they arrive with you safely. To see how the machine is packed or should be packed, please see the *Packing plan*. For unloading the packaged machine or machine components you may use a suitable crane or forklift truck.

 <b>WARNING</b>	
	<p><b>Suspended load.</b> <b>Falling loads can cause serious injury or death.</b> <b>Only use a crane or a forklift truck which is suitable for the weight and the dimensions of the load.</b></p>
	<p><b>Also use a suitable stopping means and pay attention to the gravity centre location.</b> <b>Do not step under the suspended load.</b> <b>Wear a safety helmet in addition to your basic protective gear.</b></p>

- ↓ After unloading, remove the packaging material and all transportation safety devices.
- ↓ In the case that the granulator and its accessory components have been delivered as individual items, mount these at the site of application using the mounting screws sent with the delivery exactly in accordance with the data given in the *Assembly drawing*. Only in this way can it be guaranteed that there are sufficient delivered piping parts, tubing and cable connections and that the linking places match.

 <b>WARNING</b>	
	<p><b>Overturning or falling machine.</b> <b>Serious injury or death can result.</b> <b>In the case that you wish to erect the granulator over a pit, on a frame or on a platform, you must secure the machine by putting mounting screws through the holes on the mounting pads (see <i>Assembly drawing</i>). If assembling the machine on solid ground, this safety device is not absolutely necessary.</b></p>



- ↓ Align the machine horizontally with the help of a suitable spirit level.  
Do not use blocks to place underneath the machine, use instead metal strips in order to prevent buckling of the base frame. Make sure that an even distribution of weight is achieved on all the points of support.

**ORIGINAL INSTRUCTION**  
**PART A: Basic machine**  
**Granulator C 40 Series**

---



**6.4 Connections**

**6.4.1 Electrical connection**

 <b>WARNING</b>	
	<p><b>Dangerous voltage.</b> <b>Touching live parts can lead to serious injury or death.</b> <b>All work which relates to the electricity of the machine may only be carried out by trained electricians.</b> <b>Observe the currently effective EMC regulations.</b></p>

Voltage, current, frequency and protection are marked on the *Type plate*. The voltage tolerance is  $\pm 10\%$ .

- ↓ For machines, which have been supplied none pre-wired by VIRTUS the electrical connection, is to be carried out in accordance with the enclosed *Wiring diagram* in the terminal box. When doing this, the regulations of the local electricity authority are to be adhered to. The cable cross section required is to be determined according to the rated capacity of the units.

 <b>WARNING</b>	
	<p><b>When operating specific equipment caution must be taken to prevent electrical shock. Installation, service, alterations and or modifications must only be done by qualified personal and with up most safety. Not conforming to the requirements could result in bodily injury, death or costly damage.</b></p>

**HINT**



**Alterations to the wiring diagrams from VIRTUS require our approval. Failure to do this will exclude all guarantee claims.**

**The wiring schematics are located in the control panel in the event that the control panel is a part of the delivery.**

# ORIGINAL INSTRUCTION

## PART A: Basic machine

### Granulator C 40 Series

---

#### **Connection of Emergency Stop button**

The machine may only be operated with installed Emergency Stop buttons. In the case that no Emergency Stop buttons have been installed at the factory, an Emergency Stop button must be installed at the control cabinet, the second at the grinding material in feed.

#### **Checking the rotational direction**

Checking the rotational direction is part of the machine checks before initial start-up (see chapter of same name). The steps prior to this check must be carried out beforehand.

- ↓ Switch the machine on and then immediately off again for a short time (see *Switch on machine* and *Switch off machine*).
- ↓ Observe whether the discharge air fan in the drive motor is rotating in the direction of the attached direction arrow.

## HINT



If running in the wrong direction, reconnect the motor connection immediately. Damage to the machine will result from operation in the wrong direction.

#### 6.4.2 Air pressure connection

## HINT



Use only oil-free compressed air!

- ↓ Connect the maintenance unit of the roller feeder to the compressed air supply system.
- ↓ Set the TARGET pressure on the valve of the maintenance unit.

**ORIGINAL INSTRUCTION**  
**PART A: Basic machine**  
**Granulator C 40 Series**

**6.5 Machine check prior to initial start-up**

<b>Check</b>	<b>See chapter</b>
1. When granulator is open, check the knife mounting screws using a torque wrench.	<i>Replacing and checking the cutting knife mountings.</i>
2. Search the grinding chamber for foreign matter.	<i>Cleaning the machine.</i>
3. Open the suction trough on the housing lower section and check whether the screen has been inserted in accordance with the regulations.	<i>Emptying the screen</i>
4. Close granulator upper section and fasten screws tightly.	<i>Open and close the granulator e granulator.</i>
5. Examine in feed device (accessories) for foreign matter.	<i>Part B: Accessories.</i>
6. Check that the <i>Emergency Stop buttons</i> are unlocked.	
7. Check all safety devices for proper functioning.	<i>Checking the protective devices.</i>
8. Switch on machine for a short time and check rotational direction. The rotational direction can be seen at the discharge air fan of the drive motor (observe running direction arrow).	
9. Allow machine to run for approx. 10 minutes without grinding material.	<i>Switch on machine.</i>
10. Connect material blower (accessories) and in feed device (accessories), check rotational direction of blower.	<i>Part B: Accessories.</i>
11. Feed grinding material uniformly. Too much grinding material can lead to overload of the machine.	<i>Manual in feed of grinding material.</i>
12. If necessary, check the temperature of the ground material.	
13. Monitor the ammeter. This displays the present current consumption and in this way gives information on the load of the machine. The ammeter is only integrated into granulators which have been delivered with an electrical control system.	
14. Open the air regulating flap on the by-pass flap far enough so that the bin is completely emptied (do not open further!).	<i>Discharge of grinding material</i>

## 7 OPERATION

Have you read and understood the operation manual, in particular the safety advice in the chapter on? You may not operate the machine until you have done so!

### TIP



Should faults occur during work with the machine, please observe the advice in the chapter Troubleshooting

### 7.1 Machine checks before switching on the machine

Check	See
1. The knives are properly set and the screws are tightened with the specified torque.	<i>Replacing and checking the cutting knife mountings.</i>
2. The screen is inserted into the screen support in accordance with the rules and the screen support is held fixedly at the end position due to the tightened mounting screws.	<i>Emptying the screen..</i>
3. The grinding chamber is free of foreign matter.	<i>Cleaning the machine.</i>
4. The suction trough below the screen support is closed.	<i>Emptying the screen.</i>
5. The granulator upper section is closed and screwed to the granulator lower section.	.
6. All safety devices including those of the installed grinding material in feed and discharge devices are checked and operative.	<i>Checking the protective devices.</i>
7. The material blower is installed properly and the air regulating flap on the suction trough is set so that the grinding material can be completely sucked away.	<i>Part B: Accessories.</i>
8. Roller feeder is free of foreign matter.	.
9. The roller feeder and cutting chamber are closed and the bolts are fixed.	
10. All safety devices are mounted and operative.	

### 7.2 Switch on machine

1. Switch on the grinding material discharge device.
2. Switch on the granulator (main switch to 1). Wait until the rotor has reached its full speed and switched from star to delta.
3. Switch on the grinding material in feed device (accessories).



**ORIGINAL INSTRUCTION**  
**PART A: Basic machine**  
**Granulator C 40 Series**

---

**7.3 Switch off machine**

- 1. Switch off the grinding material in feed device (accessories).
- 2. Wait until the remaining grinding material has been ground, then switch off the granulator, (main switch to 0).
- 3. Switch off the grinding material discharge device.

**7.4 Manual in feed of grinding material**

 <b>DANGER</b>	
	<p><b>Rotating knives.</b> <b>Can cause serious cutting and crushing injuries, possibly leading to death.</b> <b>Do not reach into the in feed hopper or lean in whilst the rotor is running (pay attention to the 3 minute run down time). Only use approved grinding material.</b></p>

↓ Throw the grinding material into the grinding chamber through the splash guard.

If in your design of machine an additional in feed device is installed, please observe the additional information for work with and on the in feed device *Part B: Accessories*.





**ORIGINAL INSTRUCTION**  
**PART A: Basic machine**  
**Granulator C 40 Series**

**8 MAINTENANCE**

**8.1 Safety advice**

Trained specialist personnel may only carry out work included within the framework of maintenance. Carry out the maintenance work within the specified time and document this. The machine will thank you for this by providing high reliability.

 <b>WARNING</b>	
	<b>Danger caused by electrical voltage and starting the machine during maintenance work. Mortal danger.</b>
	<b>Therefore, as a basic rule when carrying out maintenance work: Main switch to 0, safeguard using padlock and attach a warning sign.</b>

**8.2 Maintenance plan**

The tasks for maintenance work are described in detail in this chapter.

<b>Maintenance work</b>	<b>Every day</b>	<b>Every week</b>	<b>Every month</b>
Check protective devices for proper functioning.		<b>x</b>	
Clean machine.		<b>x</b>	
Check cutting knife mountings.	<b>x</b>		
Check the main bearings and regrease 80g			<b>x</b>
Lubricant replacement, lubricant renewal	<b>See motor manual</b>		
Check "V"-belt tension force and "V"-belt condition.			<b>x</b>
Check condition of cutting knives.		<b>x</b>	
Check all screws of the machine for a tight fit.		<b>x</b>	
Check wearing parts. (screen, wear plates)			<b>x</b>

**Yearly maintenance**



The purpose of yearly maintenance of the machine is primarily to check the general condition of the machine and to arrange for the supply of any necessary replacement parts in good time. A service engineer from VIRTUS EQUIPMENT can also carry this out on request.

**8.3 Checking the protective devices**

For this, see also the chapter *Protective devices*.

Check the safety devices for:

- Stipulated condition,
- Stipulated location,
- Safe mounting,
- Stipulated function.

 <b>WARNING</b>	
	<p><b>Danger due to non-functioning protective devices. Serious injury or death can result.</b></p> <ul style="list-style-type: none"><li>• <b>Eliminate all defects before you put the machine into operation!</b></li><li>• <b>If defects occur during operation, stop the machine immediately and eliminate the defects!</b></li><li>• <b>Do not change or remove any protective devices. Do not put any protective devices out of action by modifying them.</b></li></ul>

**ORIGINAL INSTRUCTION**  
**PART A: Basic machine**  
**Granulator C 40 Series**

---

**8.4 Open and close the granulator**

For some maintenance work it is necessary to open the granulator.

<b>! WARNING</b>	
	<p><b>Granulator upper section pivots downwards. Serious injury can result. Always open the granulator upper section completely. Intermediate positions are not allowed. Make sure when closing that no persons are in the danger area.</b></p>

<b>! CAUTION</b>	
	<p><b>Front door and hopper can only be opened after key switch “DOOR OPEN” has been activated. Before restart the machine Key switch “DOOR OPEN” need to be deactivated.</b></p>

**8.4.1 Opening the granulator upper section**

**Proceed as follows:**

- ↓ Switch off the granulator at the main switch
- ↓ Activate the key switch “MAINTENANCE”
- ↓ Open the soundproof housing
- ↓ Open the bolts, which are connecting the lower with the upper section of the granulator.



- ↓ Open the hopper by using the electric jack, by pushing the start buttons of the 2 hand switch on the top of the control panel. ( Selector switch at OPEN)

**ORIGINAL INSTRUCTION**  
**PART A: Basic machine**  
**Granulator C 40 Series**

---

**8.4.2 Closing the granulator**

**Proceed as follows:**

- ↓ Clean all surfaces between the granulator upper section and the granulator lower section with a hand brush as well as all contact surfaces on the screen.
- ↓ Check that there are no objects in the grinding chamber.
- ↓ Close the hopper slowly to ensure that all parts fit properly, by pushing the start buttons of the 2 hand switch on the control arm. (Selector switch at CLOSE)
- ↓ Tighten the connecting bolts between the granulator lower section and the granulator upper section.
- ↓ Close the soundproof housing
- ↓ Deactivate the key switch "MAINTENANCE"
- ↓ Machine can be started again.

# ORIGINAL INSTRUCTION

## PART A: Basic machine

### Granulator C 40 Series

---

#### 8.5 Replacing the screen

In order to keep the throughput of the granulator and the quality of the grinding material constant, the condition of the screen must be checked regularly.

The screen may be damaged, dirty or not suitable for the grinding material:

- Screen holes too fine: overheating of the grinding material.
- Screen holes too course: parts in ground material which are too big.



#### **Proceed as follows:**

- ↓ Switch off the granulator at the main switch, safeguard main switch using a padlock
- ↓ Activate the key switch “MAINTENANCE”
- ↓ Open the housing flap.
- ↓ Pull out the suction bin
- ↓ Unfasten the screen support mounting screws.





- ↓ Pivot the screen support downwards, by hand by using the handle
- ↓ Remove the screen.
- ↓ Put a new screen into the screen support.
- ↓ Pivot the screen support into the working position and fasten using the mounting screws.
- ↓ Slide in the suction bin
- ↓ Close the housing flap.
- ↓ Close the soundproof housing
- ↓ Deactivate the key switch “MAINTENANCE”
- ↓ Granulator can be started again.

## 8.6 Cleaning the machine

 <b>WARNING</b>	
	<p><b>Danger of cutting caused by sharp cutting knives, even when the rotor is at a standstill.</b> <b>Serious injury, particularly to hands and fingers, can result.</b> <b>Wear protective gloves.</b></p>

**Proceed as follows:**

- ↓ Open granulator (see *Opening the granulator* ).
- ↓ Remove the screen.
- ↓ Empty the screen.

 <b>WARNING</b>	
	<p><b>Inhalation of grinding dust which is dangerous to the health.</b> <b>This can result in injury to the respiratory tract.</b> <b>Never blow out the grinding material residue, use suction instead.</b> <b>Wear breathing protection if necessary.</b></p>

- ↓ Pre-clean the grinding chamber using a hand brush.
- ↓ Suck up the remaining grinding material residue using a suitable suction device.
- ↓ Remove clinging grinding material residue using a suitable wooden scraper.
- ↓ Put the screen into the screen support.
- ↓ Pivot the screen support into the working position using the lever and fasten with the mounting screws
- ↓ Close the granulator upper section (see *Closing the granulator*).
- ↓ Lock all safety switches
- ↓ Machine can be started again

## **8.7 Replacing the main bearings**

The main bearings of the machine are dimensioned so that a bearing replacement is only necessary in exceptional cases. Dismounting and mounting of the bearings requires specialist knowledge and a careful working method. Therefore, in addition to the following advice, please observe the instructions given in the installation manual of the bearing manufacturer.

The bearings mounted in this machine are indicated in the spare parts list. A requirement for dismounting and mounting the bearings is a suitable pulling-off device.

### **8.7.1 Dismounting the main bearings**

**To dismount the bearings proceed as follows:**

The parts which are marked with a piece number are illustrated in the drawings of the spare parts list!

- ↓ Dismount the "V"-belts
- ↓ Loosen the tensioning element for the "V"-belt pulley (see, *Mounting and dismounting TAPER-LOCK tensioning element*).
- ↓ Pull the "V"-belt pulley off the rotor axis, do not tip up. Use suitable lifting and stopping means.
- ↓ Pull the distance sleeve off the rotor axis.
- ↓ If the granulator is equipped with a disk fly wheel, dismount this in the same way as the "V"-belt pulley.
- ↓ Open the granulator upper section (see *Opening the granulator*).
- ↓ Dismount the cutting knives (see *Dismounting the cutting knives*).
- ↓ Unscrew the bearing housing from the granulator lower section.
- ↓ Carefully lift out the complete rotor using suitable lifting and stopping means.
- ↓ Lay the rotor down in a safe location. Suitable for this are timber beams of appropriate size.
- ↓ Loose the bearings cover mounting screws and take off the bearing cover.
- ↓ Pull the bearing housing off with a pulling-off device.
- ↓ Pull the bearing off the rotor axis using a pulling-off device.

**ORIGINAL INSTRUCTION**  
**PART A: Basic machine**  
**Granulator C 40 Series**

---

**8.7.2 Mounting the main bearing**

**To mount the bearings proceed as follows:**

- ↓ Before mounting, clean the bearing surfaces and the shaft surfaces thoroughly and grease lightly.
- ↓ Mount bearing in bearing housing.
- ↓ Attach the bearing with the bearing housing to the rotor axis.

**HINT**



- During mounting, the mounting forces must always engage into the inner ring, otherwise the roller bodies will be damaged.
  - The hardened bearing rings are sensitive to impact stress. For this reason, never hit directly on the rings with the hammer, use instead preferably a brass arbor or better still a striking bush (piping piece) made from a soft material. The inner diameter of the striking bush should be only slightly larger than the diameter of the bearing base.
  - The bearing is then pushed onto the shaft using light blows. When doing this, the force of pressure must be evenly distributed on the circumference of the bearing ring.
- ↓ Lift the rotor using suitable lifting and stopping equipment and put carefully into the receptacle of the granulator lower section.
  - ↓ Attach the bearing housing to the granulator lower section using screws.
  - ↓ Mount the cutting knives.
  - ↓ Close the granulator upper section (see *Closing the granulator*).
  - ↓ If the granulator is equipped with a disk flywheel:
    - ↓ Push the disk flywheel onto the rotor axis and tighten using the tensioning element.
    - ↓ Push the distance sleeve onto the rotor axis.
  - ↓ Mount the "V"-belt pulley and tighten using the tensioning element. (see, *Mounting and dismounting TAPER-LOCK tensioning element*).
  - ↓ Pull on "V"-belts and adjust the "V"-belt tension force (see *Retensioning and relaxing the "V"-belts*).
  - ↓ Carry out a test run.



**ORIGINAL INSTRUCTION**  
**PART A: Basic machine**  
**Granulator C 40 Series**

---

**8.8 Lubricating the main bearings**

An important requirement for high operational safety and long service life of the arrangement of bearings is the correct lubricant supply. Every VIRTUS machine is greased and checked in test runs before delivery.

**HINT**



**Unsuitable lubricant, lubricant deficiency, excessive lubrication or impurities in the lubricant lead to overheating and thus extreme wear of the bearings.**

**8.8.1 Lubrication intervals:**

<b>Shift operation</b>	<b>Replace lubricant</b>	<b>Check</b>
One shift operation:	every 18 months	monthly
Two shift operation:	every 9 months	monthly
Three shift operation:	every 6 months	monthly

**8.8.2 Check lubricant quality**

You can judge whether the lubricant needs to be replaced by checking for the following features:

- change in consistency,
- discolouration,
- degree of soiling.

**8.8.3 Replacing or refilling lubricant**

**HINT**



- Fill the bearings uniformly with grease, so that all operating surfaces are well greased.
- For the rotor bearings, a lubricant quantity of one third to a maximum of half of the bearing volume per bearing is required. If too much grease is filled in, the lubricant will become unusable as a result of excessive temperature.
- Only one type of grease may be used, mixing different types of grease is not allowed. The bearings have been filled at the factory with lithium base saponification roller bearing grease F3.
- To find out which lubricants from which manufacturers you can use, look in the *List of lubricants*.

# ORIGINAL INSTRUCTION

## PART A: Basic machine

### Granulator C 40 Series

---

#### **Refilling lubricant**

The grease reaches through the circulating grooves and bores via lubrication nipples into the interior of the bearing.  
The greasing quantity is 60 to 100 g roller bearing grease F3 per bearing.

Illustration:  
Grease nipple



#### **Replacing lubricant**

Only in the case of unusual bearing noises or overheating is it also necessary to renew the lubricant between the specified intervals. Mounting and dismounting of the bearings is to be carried out in accordance with the instructions in this operation manual (see *Replacing the main bearing*).

- ↓ Open the bearing.
- ↓ Remove the bearing housing and the bearing cover.
- ↓ Clean the bearing carefully using petroleum ether.  
Petroleum ether, petroleum, spirit, aqueous neutral or alkaline cleaning agents may be used to clean the bearings. After washing out, the bearing must immediately be preserved using lubricant, in order to avoid corrosion.
- ↓ Fill bearing with approved lubricant (see *List of lubricants*).

**ORIGINAL INSTRUCTION**  
**PART A: Basic machine**  
**Granulator C 40 Series**

---

**8.8.4 List of lubricants**

<b>Country of manufacture / manufacturer</b>	<b>Roller bearing grease</b>
ARAL	ARAL Grease HL 3
BP	BP ENERGREASE LS 3
CASTROL	CASTROL SPHEEROL AP 3
ESSO	Beacon 3
FUCHS	FUCHS Grease 1200 FUCHS Grease FWA 220
SHELL	SHELL Alvania Grease 3
MOBIL-OIL	MOBILUX 3
WISURA	WISURA Liba L 3
Zeller & Gmelin	ZET GE Grease M 50
FAG	FAG L 71
ANTAR Petroles de l'Atlantique	ROLEXA
Holland, Beverol	Beverol Multi Purpose Grease
Italy, Agip	AGIP Grease 33 FD
Swede, NYNÄS	Nynäs FI 3-42

**ORIGINAL INSTRUCTION**  
**PART A: Basic machine**  
**Granulator C 40 Series**

**8.9 Mounting and dismounting TAPER-LOCK tensioning element**

The motor-"V"-belt pulley is attached onto the shaft by means of a TAPER-LOCK tensioning element. The disks must be dismantled for certain maintenance work.

**IMPORTANT:** Follow all instructions in this manual carefully. This is necessary to insure satisfactory performance.

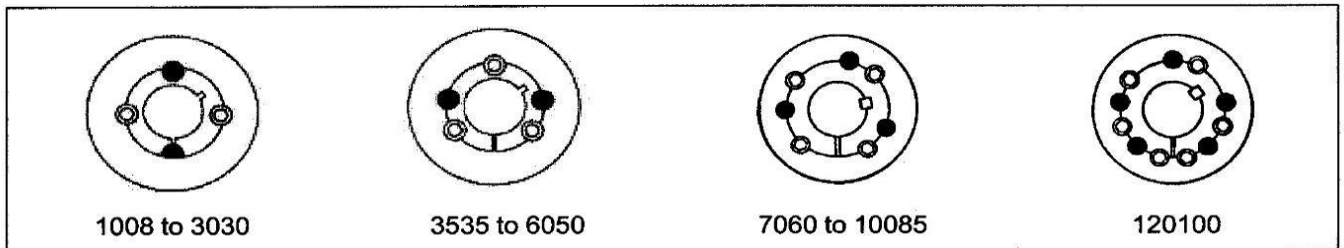

**To Install:**

1. Clean shaft, bore, and outside of bushing, and bore of hub (taking bushing from hub if already assembled). Remove any oil, lacquer, or dirt. Place bushing in hub and match half holes to make complete holes (each complete hole will be threaded on one side only).
2. Oil thread and point of set screws or thread and under head of cap screws. Place screws loosely in holes that are threaded on hub side (shown thus  in diagram).
3. Make sure bushing is free in hub. Slip assembly onto shaft and locate in position desired.
4. Tighten screws (see note\*) alternately and evenly until all are pulled up very tightly. Use a piece of pipe on wrench to increase leverage. (See table for wrench torque on reverse side.)
5. Hammer against large end of bushing using hammer and block or sleeve to avoid damage. Screws can now be turned a little more using the specified wrench torque. Repeat this alternate hammering and screw re-tightening until the specified wrench torque no longer turns the screws after hammering.
6. After drive has been running under load for a short time stop and check tightness of screws. Fill other holes with grease to exclude dirt.

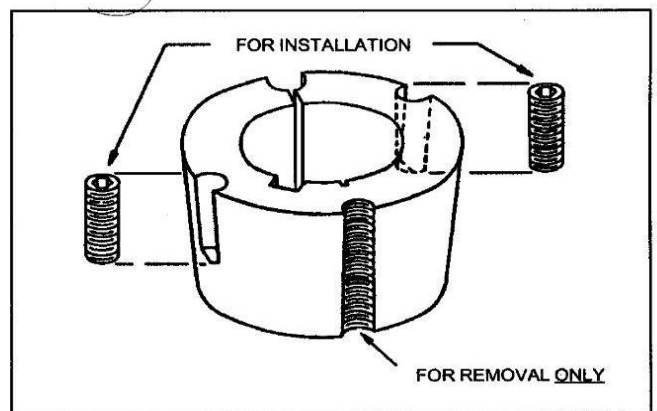

**To Remove:**

1. Remove all screws. Oil thread and point of set screws or thread and under head of cap screws.
2. Insert screws in holds that are threaded on bushing side (shown thus  in diagram). In sizes where washers are found under screw heads, be sure to use these washers. Note that one screw in each hub is left over and is not used in this loosening operation.
3. Tighten screws alternately until bushing is loosened in hub. If bushing does not loosen immediately, tap on hub.

**8.9.1 Table for the tightening torque of the screws**

Tensioning element (Type)	Screws-Tightening torque in Nm	Screw details	
		Number	Size (BSW)
2517	48	2	1/16"
3535	60	3	1/2"

**ORIGINAL INSTRUCTION**  
**PART A: Basic machine**  
**Granulator C 40 Series**

---

**8.9.2 Mounting the TAPER-LOCK tensioning element**

**Proceed as follows:**

- ↓ Remove the protective coating from the bore and outside of bush, and bore of hub. After ensuring that the mating tapered surfaces are completely clean and free from oil or dirt. Insert bush in hub so that holes line up.
- ↓ Sparingly oil thread and point of grub screws, or thread and under head on cap screws. Place screws loosely in holes threaded in hub, shown thus ☉ in.
- ↓ Clean shaft and fit hub to shaft as one unit and locate in position desired, remembering that bush will hip the shaft first and then will be slightly drawn on the bush.
- ↓ Using a hexagon wrench tighten screws gradually and alternately to certain torque.
- ↓ Hammer against large-end of bush, using a block or sleeve to prevent damage. (This will ensure that the bush is seated squarely in the bore). Screws will now turn a little more. Repeat this alternate hammering and screw tightening once or twice to achieve maximum grip on the shaft.
- ↓ If a key is to be fitted place it in the shaft keyway before fitting the bush. It is essential that it is a parallel key and side fitting only and has TOP CLEARANCE.
- ↓ After drive has been running under load for a short time stop and check tightness of screws.
- ↓ Fill empty holes with grease to exclude dirt.

**8.9.3 Dismounting the TAPER-LOCK tensioning element**

**Proceed as follows:**

- ↓ Slacken all screws by several turns, remove one or two according to number of jacking off holes shown thus • in the illustration. Insert screws in jacking off holes after oiling thread and point of grub screws or thread and under head of cap screws.
- ↓ Tighten screws alternately until bush is loosened in hub and assembly is free on the shaft.
- ↓ Remove assembly from shaft.

**ORIGINAL INSTRUCTION**  
**PART A: Basic machine**  
**Granulator C 40 Series**

**8.10 Work on the "V"-belts**

"V"-belts are wearing parts, which stretch and must be retensioned. In order to guarantee a long service life of the "V"-belts, regular checks on the tension force of the "V"-belts and the condition of the "V"-belts are necessary.

**8.10.1 Checking the tension force of the "V"-belt**

Illustration:

- a: Distance between roller centres
- b: Sag
- F: Force(direction)

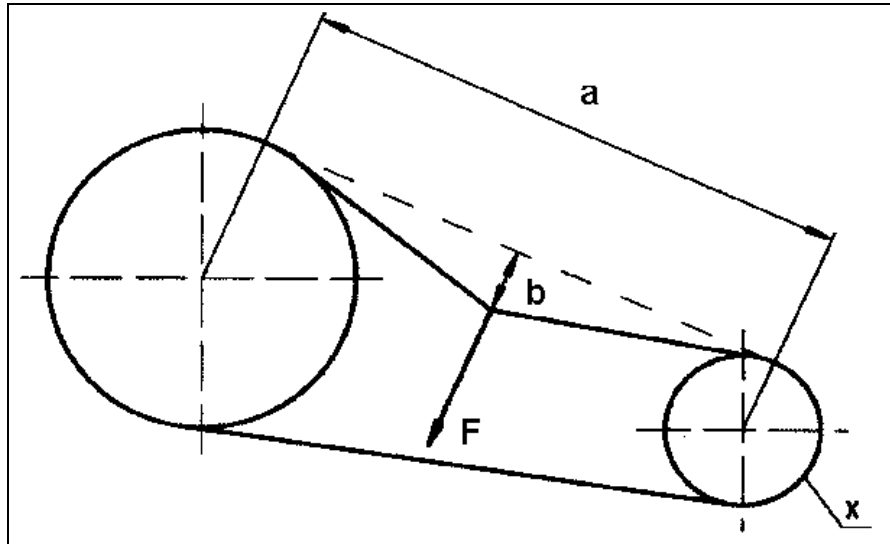

- ↓ Remove the "V"-belt cover.
- ↓ Measure the distance between the roller centres.
- ↓ Determine the belt sag force F for each belt at 16 mm sag if sag "b" is equal to 1 m distance between roller centres. Do this by measuring at the middle of the distance between roller centres at a right angle to the "V"-belt.

		<b>Force required for 1 m distance between roller centres and 16 mm sag</b>	
<b>Profile section</b>	<b>Efficiency of x in mm</b>	<b>P in Newton</b>	<b>P in lbs</b>
SPB	160 - 224	35 - 50	7,7 - 11
SPB	236 - 315	50 -65	11 - 14,3

- ↓ Compare determined value with the value in the above table. If the value lies below the lowest tolerance limit, the "V"-belt must be retensioned. If the value lies above the highest tolerance limit, the "V"-belt must be relaxed.

**ORIGINAL INSTRUCTION**  
**PART A: Basic machine**  
**Granulator C 40 Series**

---



**8.10.2 Retensioning and relaxing the "V"-belt**

Enlarging or decreasing the centre distance "A" into which the drive motor is shifted carries out tensioning or relaxing the "V" - belt.

**Proceed as follows:**

- ↓ Loosen the tensioning screw.
- ↓ Shift the drive motor as required onto the sliding rails.
- ↓ Lock the drive motor into new position using both tensioning screws in such a way that the motor shaft is parallel to the rotor axis and aligned.
- ↓ Check the tension force of the "V"-belt (see *Checking the tension force of the "V"-belt*).
- ↓ Mount the "V"-belt cover.

**8.10.3 Checking "V"-belt condition, replacing "V"-belt**

 <b>CAUTION</b>	
	<p><b>Danger of pulling into machine caused by running "V"-belts.</b> <b>Hair, jewellery etc. can be pulled into the machine. Serious injury can result.</b> <b>Never dismantle the "V"-belt cover and window during operation.</b></p>

- If a "V"-belt is porous or ripped, it must be replaced as follows.
- ↓ Loosen the front and rear tensioning screw.
  - ↓ Relax the "V"-belt by shifting the drive motor.
  - ↓ Put new "V"-belt in.
  - ↓ Tension the "V"-belt (see *Retensioning and relaxing the "V"-belts*).

# ORIGINAL INSTRUCTION

## PART A: Basic machine

### Granulator C 40 Series

---

#### 8.11 Working on the cutting knives

In the case of granulators, the correct grinding properties, correct setting and mounting of the cutting knives are important factors to ensure perfect functioning and economic operation of the machine.

##### 8.11.1 Replacing and checking the cutting knife mountings

Due to their function, certain machine parts are subject to stress in their operating state as a result of vibrations, which can lead to loosening of the screw connections. Therefore, it is absolutely necessary to check the cutting knife mounting screws in accordance with the *Maintenance plan*.

- ↓ Tighten the mounting screws on the cutting knives using a torque wrench which is set to the required torque for the screw size.  
**The required torque for the knife fixing bolts is 580 Nm.**

You can find out the required torque from the following table. Take note too that the tightening capacity decreases of screws which have been loosened and tightened again several times. New screws of the same material quality must therefore replace the cutting knife mounting screws after they have been loosened and tightened several times.

#### Torque:



Bolt type	Grade 8.8		Grade 10.9		Grade 12.9	
	Nm	lbf ft	Nm	lbf ft	Nm	lbf ft
M8	25	18.4	35	25.8	41	30.2
M10	49	36.1	69	50.9	83	61.2
M12	86	63.4	120	88.5	145	106
M16	210	154	295	217	355	261
M20	410	302	580	428	690	508
M24	710	523	1000	737	1200	885



**ORIGINAL INSTRUCTION**  
**PART A: Basic machine**  
**Granulator C 40 Series**

---

**8.11.2      Checking the condition of the cutting knives**

 <b>WARNING</b>	
	<p><b>Danger of cutting caused by sharp knives, even when the rotor is at a standstill.</b> <b>Serious injury, particularly to hands and fingers, can result.</b> <b>Wear protective gloves.</b></p>

The cutting knives become blunt after a certain number of operation hours. Therefore they should be checked regularly.

**Using blunt knives has the following consequences:**

- Decreased grinding capacity.
- Increased current consumption of the drive motor.
- Inexact cut.
- Overheating of the ground material.

**ORIGINAL INSTRUCTION**  
**PART A: Basic machine**  
**Granulator C 40 Series**

---

**8.11.3 Dismounting the cutting knives**

**! WARNING**



**Danger of cutting caused by sharp knives, even when the rotor is at a standstill. Serious injury, particularly to hands and fingers, can result. Wear protective gloves.**

**Proceed as follows:**

Illustration:

- (1) Rotor knife
- (2) Knife mounting screws

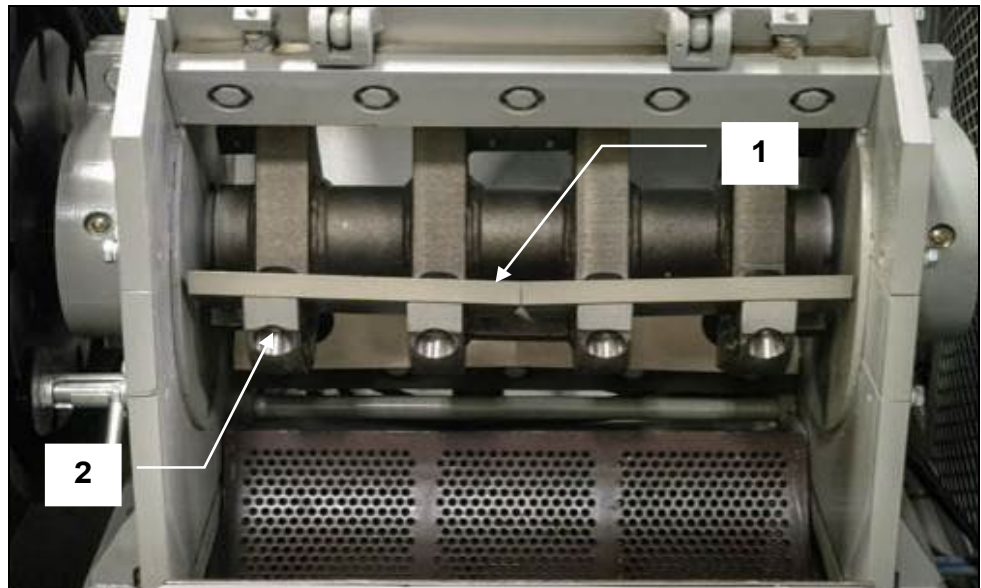



- ↓ Open the granulator (see *Opening the granulator* ).
- ↓ Safeguard the rotor against torsion by using the “**ROTOR LOCK**”
- ↓ Loosen the knife mounting screws.
- ↓ Take out the knife capping and knives.

**ORIGINAL INSTRUCTION**  
**PART A: Basic machine**  
**Granulator C 40 Series**

---

**8.11.4 Mounting the cutting knives**

 <b>WARNING</b>	
	<p><b>Danger of cutting caused by sharp knives, even when the rotor is at a standstill.</b> <b>Serious injury, particularly to hands and fingers, can result.</b> <b>Wear protective gloves.</b></p>

## HINT



The cutting knives, in particular the rotor knives, should only be sharpened or replaced in sets. There is a danger of balance error if a combination of rotor knives from different knife sets is used.

**Proceed as follows:**

- ↓ Clean the knife supporting surface and threaded holes.
- ↓ Insert sharp and preset knives and push against the setting surface.
- ↓ Put on the knife capping.
- ↓ Screw in the mounting screws and tighten using torque wrench.

**The required torque for all knife mounting bolts is 580 Nm** (also see the table under *Replacing and checking the cutting knife mountings*).

- ↓ **Check whether the cutting gap is correct and whether the cutting knives do not collide as the rotor turns.**

## TIP



**Stator knives from VIRTUS have two symmetrical cutting edges.**

**This makes it possible to turn the knives and only to sharpen after every second knife change.**

- ↓ Remove tools and other objects from the grinding chamber.
- ↓ Unlock the **“ROTOR LOCK”**
- ↓ Close the granulator upper section (see Closing the granulator)
- ↓ Switch on the granulator for a short time without grinding material and listen for noises. If you hear unusual noises, determine the cause and eliminate it.

**ORIGINAL INSTRUCTION**  
**PART A: Basic machine**  
**Granulator C 40 Series**

---

8.11.5 Sharpening cutting knives



**TIP**

Specialist sharpening of the cutting knives is part of the service offer of VIRTUS .

 **WARNING**



Danger of cutting caused by sharp knives, even when the rotor is at a standstill. Serious injury, particularly to hands and fingers, can result. Wear protective gloves.

**HINT**



The cutting knives, in particular the rotor knives, should only be sharpened or replaced in sets. There is a danger of balance error if a combination of rotor knives from different knife sets is used.

**Proceed as follows:**

- ↓ Dismount the cutting knives (see *Dismounting the cutting knives*).
- ↓ Sharpen the cutting knives.  
A specialist in accordance with the sharpening plan using particular care should uniformly sharpen the cutting knives mechanically. It is important to make sure that sharpening takes place with small grinding allowance and sufficient coolant supply. The sharpening process is finished when the cutting edge is sharply cut. Not all indentations must be ground out, otherwise the number of possibilities for sharpening is unnecessarily reduced. For the sharpening process, use soft grinding wheels (Quality 40 H or 46 K). Knives, which have grinding cracks, are not to be reused due to danger of breakage during operation.
- ↓ Whet the cutting edges of the cutting knives using a whetstone.  
By taking these measures, the service life of the cutting knives can be increased.
- ↓ Set the cutting knives (see *mounting the cutting knives*).
- ↓ Mount the cutting knives (see *mounting the cutting knives*).

**ORIGINAL INSTRUCTION**  
**PART A: Basic machine**  
**Granulator C 40 Series**

Illustration: *Resharpener plan rotor knife*

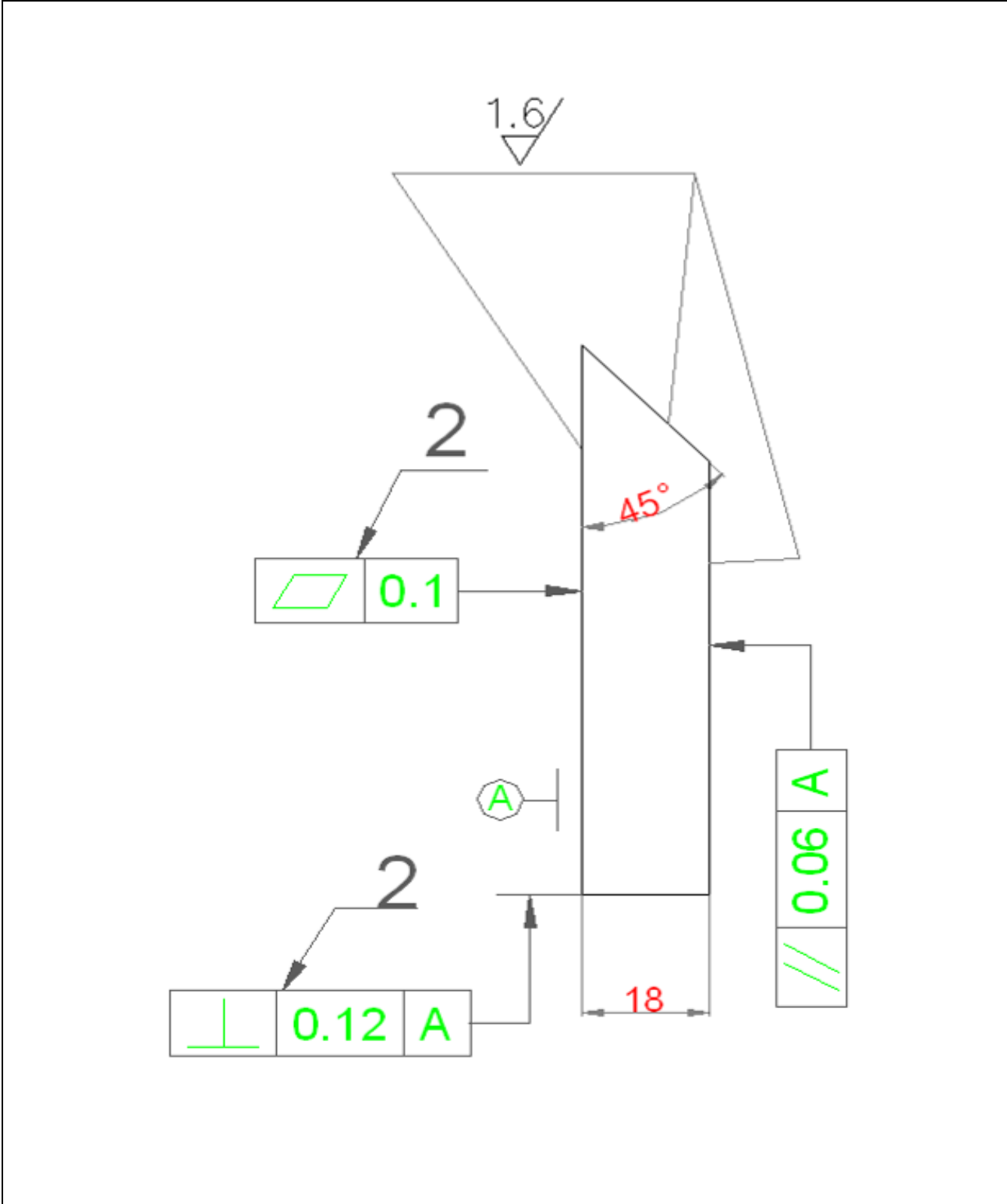

**ORIGINAL INSTRUCTION**  
**PART A: Basic machine**  
**Granulator C 40 Series**

Illustration: *Resharpener plan stator knife*

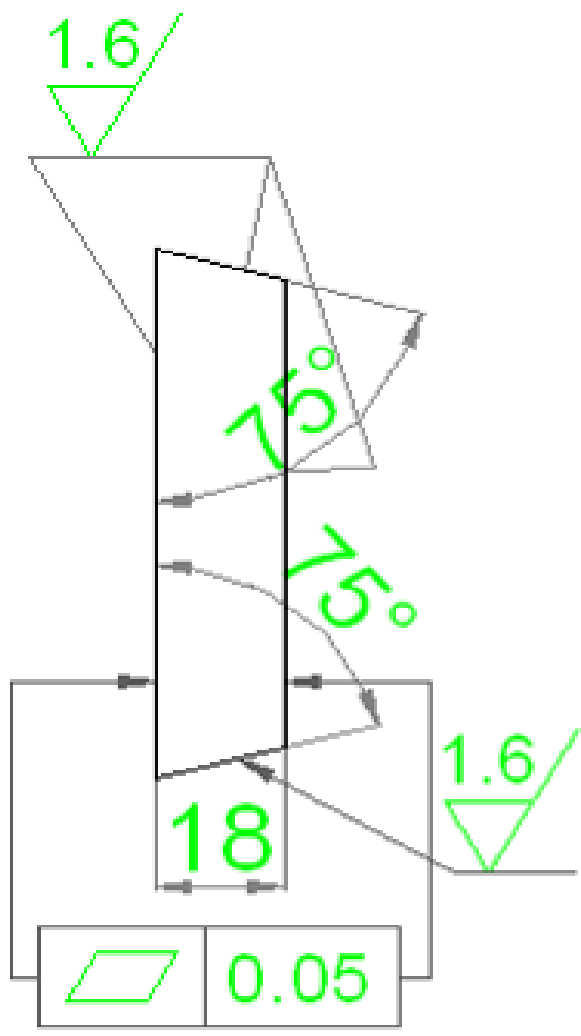

**ORIGINAL INSTRUCTION**  
**PART A: Basic machine**  
**Granulator C 40 Series**

**8.11.6 Setting the cutting knives**

<b>⚠ WARNING</b>	
	<p><b>Danger of cutting caused by sharp cutting knives. Serious injury, in particular to hands and fingers, can result. Wear protective gloves.</b></p>

To simplify knife setting and shorten standstill periods when replacing the knives, a knife setting device is delivered together with rotors with adjustable knives.

Knife setting can be carried out easily outside the machine using this setting device. If you have several knife sets, you will also avoid standstill periods of the machine.

Correct and careful setting of the gap between the rotor knives and the bed knives (cutting gap) is an important requirement for the productive capacity of the granulator.

Factors for the size of the knife gap are the size of the rotor, the design of the rotor and the material to be ground.

The cutting gap is set using the knife gap of the rotor knives in the knife-setting device.

Illustration: *Cutting gap*

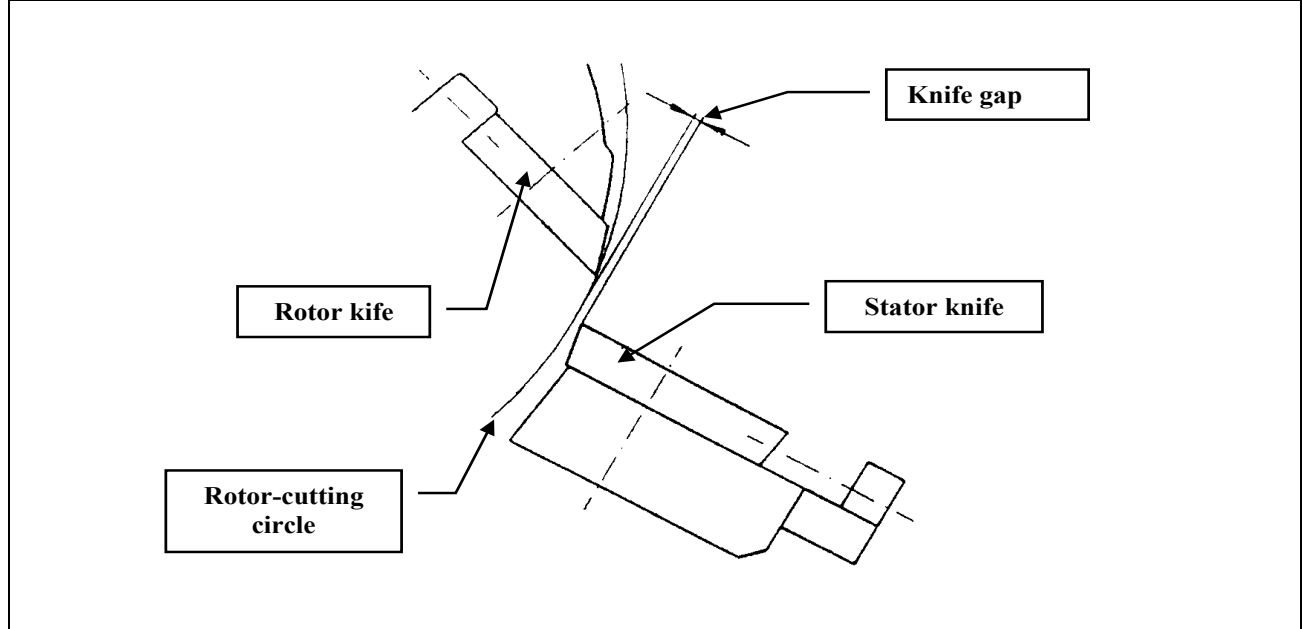

**ORIGINAL INSTRUCTION**  
**PART A: Basic machine**  
**Granulator C 40 Series**

---

**For setting the rotor knives, proceed as follows:**

Illustration:

Knife setting device

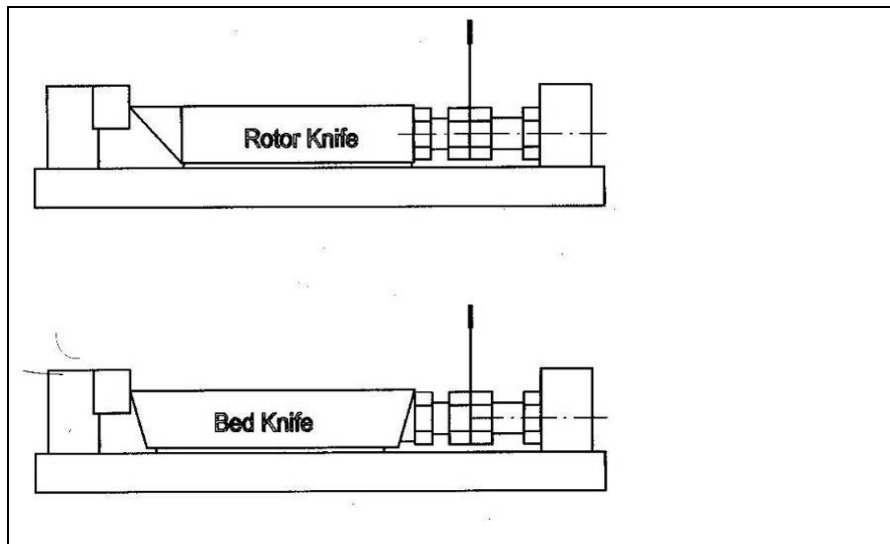
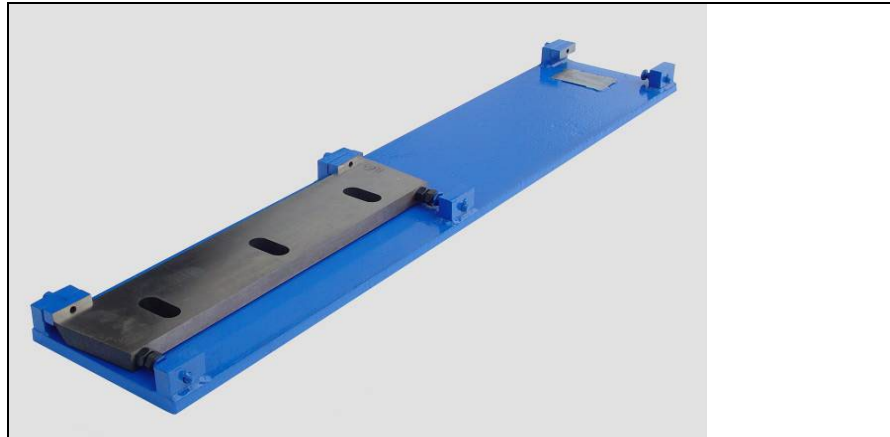

- ↓ Insert the knives into the knife setting device as shown.
- ↓ Select the guide calibre appropriate for the size of the knife gap from the delivered guide calibre set.  
The guide calibres are marked with numbers, which when divided by 100, give the thickness in mm.

**Further procedure for each setting screw:**

- ↓ Push the guide calibre between the stopper of the knife setting device and the setting screw of the cutting knife.  
Doing this, the knife edge must lie against the stopper.
- ↓ Unscrew the setting screw of the knife so far that the feeler gage is gently squeezed.
- ↓ Tighten the counter nut.
- ↓ Set all the setting screws as described.  
Check the knife gap at the end of setting and correct if required.



**ORIGINAL INSTRUCTION**  
**PART A: Basic machine**  
**Granulator C 40 Series**

**Recommended knife gap: 0,3mm**

Illustration:

- (1) Rotor knife
- (2) Knife fixing bolt
- (3) Cover plate

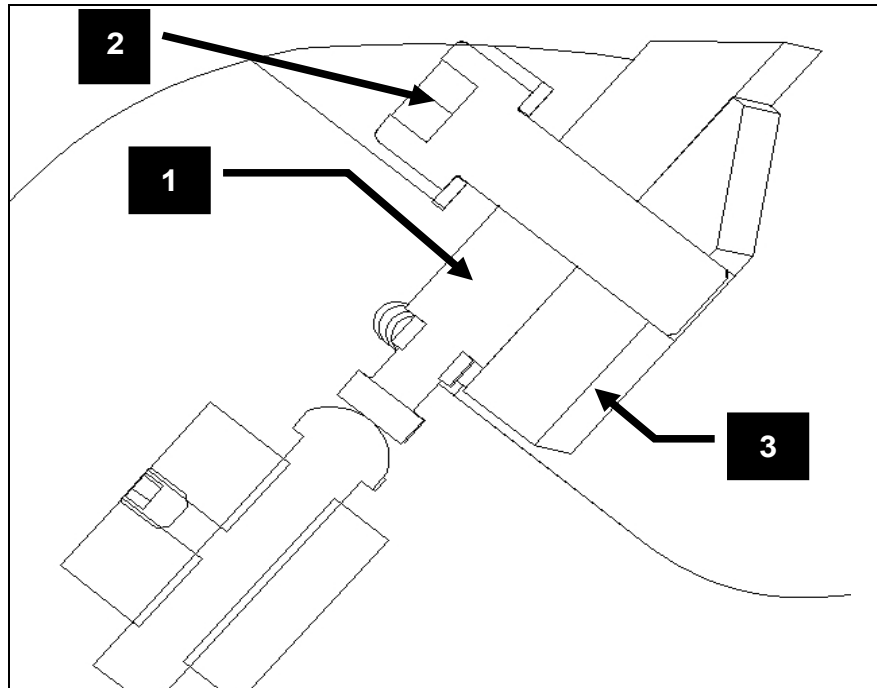

## HINT



In operating state, the granulator heats up and expands unevenly. Therefore, if the knife gap is too small this can lead to machine damage caused by the knives colliding.

As a basic rule, the knife gap between rotor knives and stator knives must be 0,3 mm.

### 8.11.7 Transporting and storing the cutting knives

#### **WARNING**



**Danger of cutting caused by sharp cutting knives. Serious injury, in particular to hands and fingers, can result. Only transport and store the cutting knives packaged. Grease the cutting knives well, so that they do not rust. Protect the cutting edges with doubled cardboard and use adhesive tape to safeguard the knives against slipping out of the sides of the sheath.**

**After unpacking, you must degrease the cutting knives so that they can be gripped safely.**

## **9 TROUBLESHOOTING**

### **9.1 Machine blocks or switches itself off**

<b>No.</b>	<b>Possible causes</b>	<b>Remedy required</b>
9.1.1	Too much feed material.	Reduce grinding material in feed.
9.1.2	Screen blocked.	Clean screen, check condition, if necessary select larger screen perforation.
9.1.3	"V"-belts slip.	Check "V"-belt tension and condition and retighten if necessary or replace.
9.1.4	Knife condition.	Check knives and resharpen or replace if needed.
9.1.5	Cutting gap.	Check cutting gap and set according to the instructions in this operation manual.
9.1.6	Suction trough blocked.	Change in rotational direction of blower needed. Replace fan blades if necessary. Open the air regulating flap on the suction trough as far as necessary. Check discharge air flow from cyclone for blockages.
9.1.7	Current failure.	Check limit switch for defective contact. Check electrical connection, if necessary tighten limit switch.
9.1.8	Fuse too small.	Fit larger fuse. <b>Only after consulting the service department of VIRTUS .</b>
9.1.9	Frequent peak loads.	Install disk flywheel.
9.1.10	Rotational direction of rotor.	Check motor and reverse polarity if necessary.
9.1.11	Rotor speed.	Change rotor speed. <b>Only after consulting the service department of VIRTUS .</b>
9.1.12	Bed knives mounted mirror inverted.	Knife tip must protrude in direction of rotation.

### **9.2 Rotor does not grip bulky material**

<b>No.</b>	<b>Possible causes</b>	<b>Remedy required</b>
9.2.1	Knife condition.	Check and sharpen if needed according to the instructions in this operation manual.
9.2.2	Protruding bed knife.	Chamfer bed knives, consult with service department of VIRTUS .

### **9.3 Overheating of the grinding material**

<b>No.</b>	<b>Possible causes</b>	<b>Remedy required</b>
9.3.1	See 9.1.1 to 9.1.5. See 9.1.11 and 9.1.12.	See 9.1.1 to 9.1.5. See 9.1.11 and 9.1.12.
9.3.2	Screen perforation too small.	Insert a screen with larger perforation.
9.3.3	Knives wrongly sharpened.	Modify knife finish. <b>Only after consulting the service department of VIRTUS .</b>
9.3.4	Suction air.	Close air-regulating flap on suction trough step by step.
9.3.5	Material rubs against the housing wall.	Fit anti-winding device.
9.3.6	Insufficient cooling.	Fit water-spraying device, increase air intake (larger suction fan).
9.3.7	Suction fan rotates in wrong direction.	Check connection, if required reverse polarity.

**ORIGINAL INSTRUCTION**  
**PART A: Basic machine**  
**Granulator C 40 Series**

---

**9.4 Unusual vibrations**

No.	Possible causes	Remedy required
9.4.1	Rotor out of balance.	Weigh knives, balance rotor.
9.4.2	Bearing damage.	Check bearings, replace bearings if necessary.
9.4.3	Mounting pads defective (vibration elements).	Check mounting pads and renew these if necessary.

**9.5 Extreme cutter wear**

No.	Possible causes	Remedy required
9.5.1	Bearing damage.	Check bearings, replace bearings if necessary.
9.5.2	Knife finish.	Check knife and sharpen or replace if necessary.
9.5.3	Wrong cutting angle.	Modify cutting angle after consulting VIRTUS service department.
9.5.4	Wrong cutting angle.	Check cutting gap and set according to the instructions in this operation manual.
9.5.5	Foreign matter.	Fit feed device with a metal detector.

**9.6 Bearings too hot**

No.	Possible causes	Remedy required
9.6.1	Too much grease in bearing.	Reduce amount of grease.
9.6.2	"V"-belts too tight.	Reduce tension.
9.6.3	Rubbing on housing sealing ring.	Check sealing ring, oil or replace.
9.6.4	Bearing damage.	Check bearings, replace if necessary.
9.6.5	No grease in bearing.	Lubricate bearing.

**9.7 Too many fines in grinding material**

No.	Possible causes	Remedy required
9.7.1	Type of material.	Fit fines separator under cyclone.
9.7.2	Screen worn.	Renew screen, possibly using manganese steel.
9.7.3	Unsuitable screen perforation.	Replace screen after consulting VIRTUS service department.
9.7.4	Suction unit too weak.	Change rotor speed. <b>Only after consulting the service department of VIRTUS .</b>

**9.8 Cutting gap alters during operation**

No.	Possible causes	Remedy required
9.8.1	Knife mounting screws not tight.	Retighten using torque wrench in accordance with table in operation manual.
9.8.2	Screw fatigue.	Fit new screws.
9.8.3	Cover disks or plate deformed.	Insert new cover disks or plate.
9.8.4	Supporting surfaces not clean.	Clean and de-rust supporting surfaces.
9.8.5	Threads in housing worn.	Fit new bushes in housing.

**ORIGINAL INSTRUCTION**  
**PART A: Basic machine**  
**Granulator C 40 Series**

---

**9.9 Screen damage**

No.	Possible causes	Remedy required
9.9.1	Screen inserted wrongly.	Fit screen correctly.
9.9.2	Screen support buckled.	Replace screen support.

**9.10 Granulator does not start**

No.	Possible causes	Remedy required
9.10.1	Limit switches not activated.	Check position of limit switch and correct.
9.10.2	Main and control fuses.	Replace fuse.
9.10.3	Feed device not connected.	Switch on in sequence.
9.10.4	Residue material in granulator.	Empty granulator before switching on.
9.10.5	Star delta connection.	Correct wiring on motor.
9.10.6	Motor protection switches off.	Check motor relay for correct setting and increase if necessary.
9.10.7	Star delta time relay.	Correct time.

**9.11 Granulator blocks when under load**

No.	Possible causes	Remedy required
9.11.1	Feed starts too early.	Start feed only after switch over from star to delta.
9.11.2	Limit switch loose or wrongly set.	Reposition and tighten limit switch.
9.11.3	Fuse defective.	Replace fuse. Fit larger fuse. <b>Only after consulting the service department of VIRTUS GmbH.</b>
9.11.4	Motor fuse switches off - red indicator.	Reduce feed quantity of the grinding material, correct setting, replace fuse.

**9.12 Frequent switching off of grinding material in feed device**

No.	Possible causes	Remedy required
9.12.1	Current relay switches off.	Correct setting.

**ORIGINAL INSTRUCTION**  
**PART A: Basic machine**  
**Granulator C 40 Series**

---

**10 STORAGE, DISPOSAL, TRANSPORTATION**

**10.1 Storage**



Clean the machine (see *Cleaning the machine*). Preserve all polished metal surfaces using a suitable rust preventing agent. Store the machine in an enclosed, dry place. Cover the machine completely with a plastic sheet.



**10.2 Disposal**



**Protect the environment.**

The disposal of machines, machine components and process materials is partially subject to legal controls. More detailed information is given at the relevant administrative authority (e.g. regional and national Water Conservation Bureaux and Environmental Protection Agencies). Only deposit the material to be disposed of at authorized drop-off points.

**10.3 Transportation**

 <b>WARNING</b>	
	<p><b>Suspended load.</b> <b>Falling loads can cause serious injury or death.</b> <b>Only use a crane or forklift truck, which is suitable for the weight and dimensions of the loads.</b></p>
	<p><b>Also use suitable stopping means and pay attention to the gravity centre location.</b> <b>Do not step under the suspended load.</b> <b>Wear a protective helmet in addition to your basic protective gear.</b></p>

## 11 CUSTOMER SERVICE AND SPARE PARTS ORDERS



Should problems occur during operation of the machine or if you have general questions about the machine which this operation manual cannot answer, please do not hesitate to contact us. We would be pleased to help you further in order to solve your problem as quickly as possible.

You can identify the spare parts you require using the spare parts list. Please quote the following information when making your order so that we can deliver the spare parts to you quickly:

- Company name and address.
- Contact person.
- Machine type.
- Machine number.
- Piece number of the spare part.
- Spare part reference.
- Subject number.
- Order quantity.

Virtus Equipment  
9120 Centerlinks Commerce DR., Unit 4  
Fort Myers, FL 33912

Phone: +1-239-219-1500

---

**E-Mail:** [PARTS@VIRTUS-EQUIPMENT.com](mailto:PARTS@VIRTUS-EQUIPMENT.com)

**Internet:** [www.VIRTUS-Equipment.com](http://www.VIRTUS-Equipment.com)

### TIP



The easiest way to order your spare parts is to copy the spare parts list and to fill in the order amount after the respective spare part.

# ORIGINAL INSTRUCTION

## PART A: Basic machine

### Granulator C 40 Series

## 12 SPARE PARTS LIST

### 12.1 Spare Parts List C40/60

Pos.	Pc	Description/Standard	Partnumber/SAP	Order
100		<b>Machine complete</b>		
101	1	Standard hopper	25830200	
102	1	Soft Curtain	25830410	
103	1	Clamping bar for soft curtain	20808600	
104	3	Screw, DIN933 M8x35	80009640	
105	3	Washer	80010720	
106	3	Spring washer	80010840	
107	1	Hard Curtain	25830400	
108	1	Mounting for hard curtain	20809500	
109	3	Screw, DIN933 M8x50	80009650	
110	3	Washer	80010720	
111	3	Spring washer	80010840	
112	3	Nut	80010430	
113	1	Shaft for Hard curtain	25830390	
114	2	Clamp	80040065	
115	2	Hopper mounting bar	25830420	
116	8	Screw, DIN933 M12x45	80009880	
117	8	Washer	80010740	
118	8	Spring washer	80010860	
119	3	Screw, DIN933 M12x35	80009840	
120	3	Washer	80040029	
121	1	Cutting Chamber	25830500	
122	1	Base frame	25831000	
123	1	Soundproof housing	25831100	
124	4	Anti vibration pads, JSD1000	80012740	
125	1	Hopper Shaft	25830800	
126	2	Clamp	80040066	
127	2	Upper Wear plate	25830620	
128	2	Lower Wear plate	25830630	
200		<b>Screen</b>		
201	1	Screen	25830700	
202	2	Screen Cradle	25830640	
203	1	Nut, M16	80040738	
204	1	Washer	80010760	
300		<b>Bearing</b>		
301	2	Bearing	80040271	
302	2	Bearing house	25830965	
303	2	Grease nipple	80012460	
304	3	Shaft sealing	80040288	

**ORIGINAL INSTRUCTION**  
**PART A: Basic machine**  
**Granulator C 40 Series**

305	1	Bearing house cover A	23055100	
306	1	Bearing house cover B	23055000	
307	2	Bearing house cover C	23055000	
308	16	Screw	80011070	
309	1	Bush	25830980	
310	1	Disc	23057100	
311	1	Screw	80011670	
400		<b>Drive</b>		
401	1	Motor 22KWx4B3		
402	1	Motor pulley, SPB150-4	80002071	
403	1	Taper bush for Motor pulley, 2517-48	80002480	
404	1	Key for motor pulley		
405	1	Rotor pulley, SPB560-4	80002040	
406	1	Taper bush for Rotor pulley, 3535-70	80002320	
407	1	Key for Rotor pulley		
408	2	Motor mounting rails	25831020	
409	4	Screw	20210200	
410	4	Washer	80010730	
411	4	Spring washer	80010850	
412	4	Nut	80010440	
413	4	Screw, DIN933 M12x35	80009840	
414	4	Washer	80010740	
415	4	Spring washer	80010860	
416	4	Nut	90001219	
500		<b>Rotor assembly</b>		
501	1	Rotor	25830910	
502	6	Rotor knife	80052983	
503	12	Mounting Screw, DIN933 M16x50 12.9	80009980	
504	12	Washer	80012930	
505	12	Clamping disc	80052651	
506			80010540	
507	12	Adjustmant screw	20781000	
508	12	Nut	80010450	
600	2	<b>Stator knife</b>		
601	2	Stator knife	80001170	
602		Mounting Screw, DIN933 M16x60 12.9	80010010	
603		Washer, DIN433	80010760	
604		Upper Clamping plate	25830600	
605		Lower clamping plate	25830610	
606		Adjustmant screw	20782000	
607		Nut	80010450	
608		Washer	80050640	



**ORIGINAL INSTRUCTION**  
**PART A: Basic machine**  
**Granulator C 40 Series**

---

700		<b>Electrical parts</b>		
701	1	Safety switch		
702	1	Electric jack,400V50HZ	80053131	
703	1	Control panel		
704	1	Terminal box		

**ORIGINAL INSTRUCTION**  
**PART A: Basic machine**  
**Granulator C 40 Series**

**12.2 Spare Parts List C40/100**

Pos.	Pc	Description/Standard	Partnumber/SAP	Order
100		<b>Machine complete</b>		
101	1	Standard hopper		
102	1	Soft Curtain		
103	1	Clamping bar for soft curtain		
104	3	Screw, DIN933 M8x35		
105	3	Washer		
106	3	Spring washer		
107	1	Hard Curtain		
108	1	Mounting for hard curtain		
109	3	Screw, DIN933 M8x50		
110	3	Washer		
111	3	Spring washer		
112	3	Nut		
113	1	Shaft for Hard curtain		
114	2	Clamp		
115	2	Hopper mounting bar		
116	8	Screw, DIN933 M12x45		
117	8	Washer		
118	8	Spring washer		
119	3	Screw, DIN933 M12x35		
120	3	Washer		
121	1	Cutting Chamber		
122	1	Base frame		
123	1	Soundproof housing		
124	4	Anti vibration pads, JSD1000		
125	1	Hopper Shaft		
126	2	Clamp		
127	2	Upper Wear plate		
128	2	Lower Wear plate		
200		<b>Screen</b>		
201	1	Screen		
202	2	Screen Cradle		
203	1	Nut, M16		
204	1	Washer		
300		<b>Bearing</b>		
301	2	Bearing		
302	2	Bearing house		
303	2	Grease nipple		
304	3	Shaft sealing		
305	1	Bearing house cover A		
306	1	Bearing house cover B		

**ORIGINAL INSTRUCTION**  
**PART A: Basic machine**  
**Granulator C 40 Series**

307	2	Bearing house cover C		
308	16	Screw		
309	1	Bush		
310	1	Disc		
311	1	Screw		
400		<b>Drive</b>		
401	1	Motor 5.5KWx4B3		
402	1	Motor pulley, SPB118-3		
403	1	Taper bush for Motor pulley, 1610-38		
404	1	Key for motor pulley		
405	1	Rotor pulley, SPB355-3		
406	1	Taper bush for Rotor pulley, 3020-55		
407	1	Key for Rotor pulley		
408	2	Motor mounting rails		
409	4	Screw		
410	4	Washer		
411	4	Spring washer		
412	4	Nut		
413	4	Screw, DIN933 M12x35		
414	4	Washer		
415	4	Spring washer		
416	4	Nut		
500		<b>Rotor assembly</b>		
501	1	Rotor		
502	6	Rotor knife		
503	12	Mounting Screw, DIN933 M16x50 12.9		
504	12	Washer		
505	12	Clamping disc		
506				
507	12	Adjustmant screw		
508	12	Nut		
600	2	<b>Stator knife</b>		
601	2	Stator knife		
602		Mounting Screw, DIN933 M16x60 12.9		
603		Washer, DIN433		
604		Upper Clamping plate		
605		Lower clamping plate		
606		Adjustmant screw		
607		Nut		
608		Washer		
700		<b>Electrical parts</b>		
701	2	Safety switch		

**ORIGINAL INSTRUCTION**  
**PART A: Basic machine**  
**Granulator C 40 Series**

---

702	1	Electric jack,400V50HZ		
703	1	Control panel		
704	1	Terminal box		

**ORIGINAL INSTRUCTION**  
**PART A: Basic machine**  
**Granulator C 40 Series**

Illustration: Machine complete front

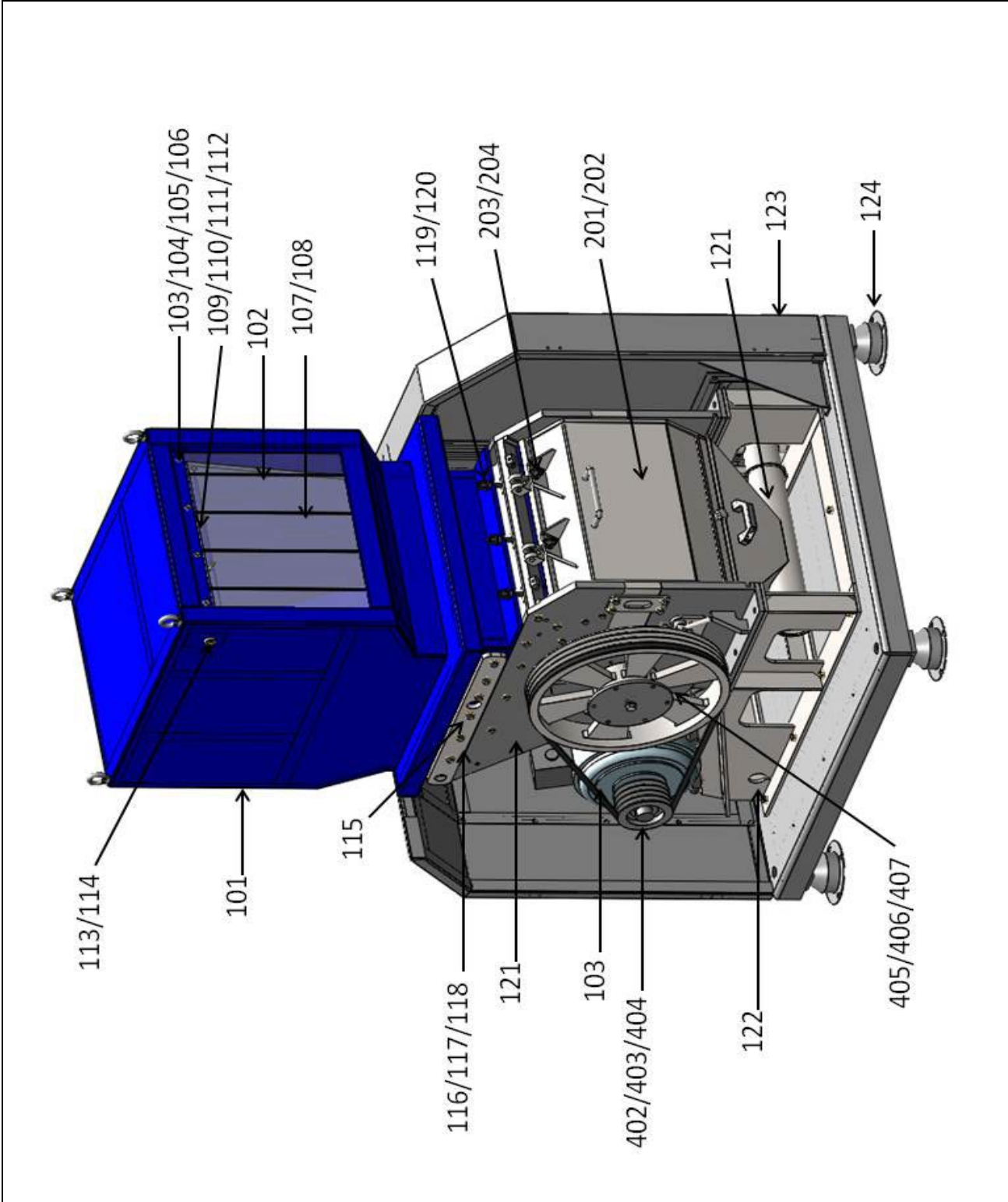

**ORIGINAL INSTRUCTION**  
**PART A: Basic machine**  
**Granulator C 40 Series**

Illustration: Machine complete back

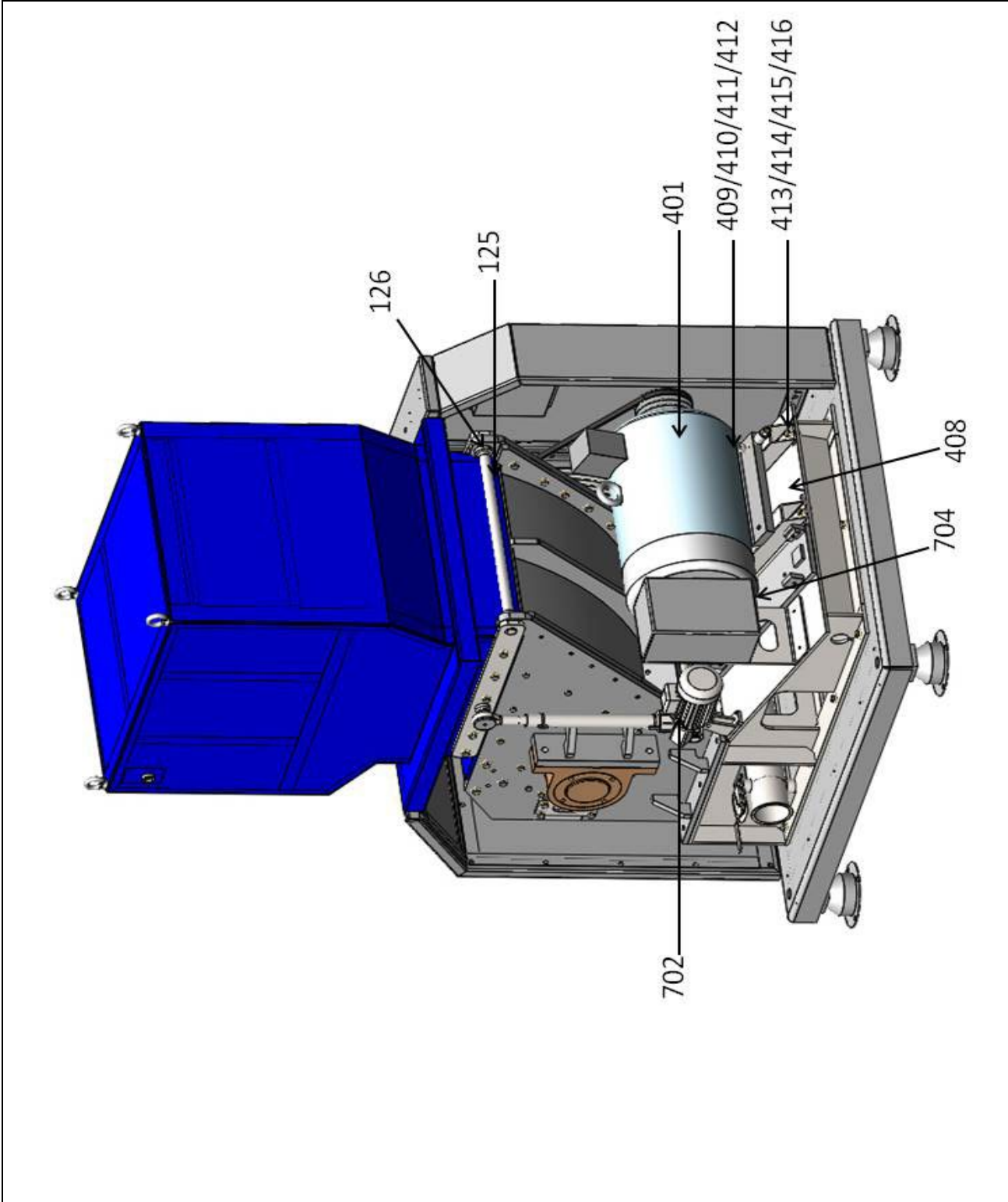

**ORIGINAL INSTRUCTION**  
**PART A: Basic machine**  
**Granulator C 40 Series**

Illustration: Rotor assembly 1

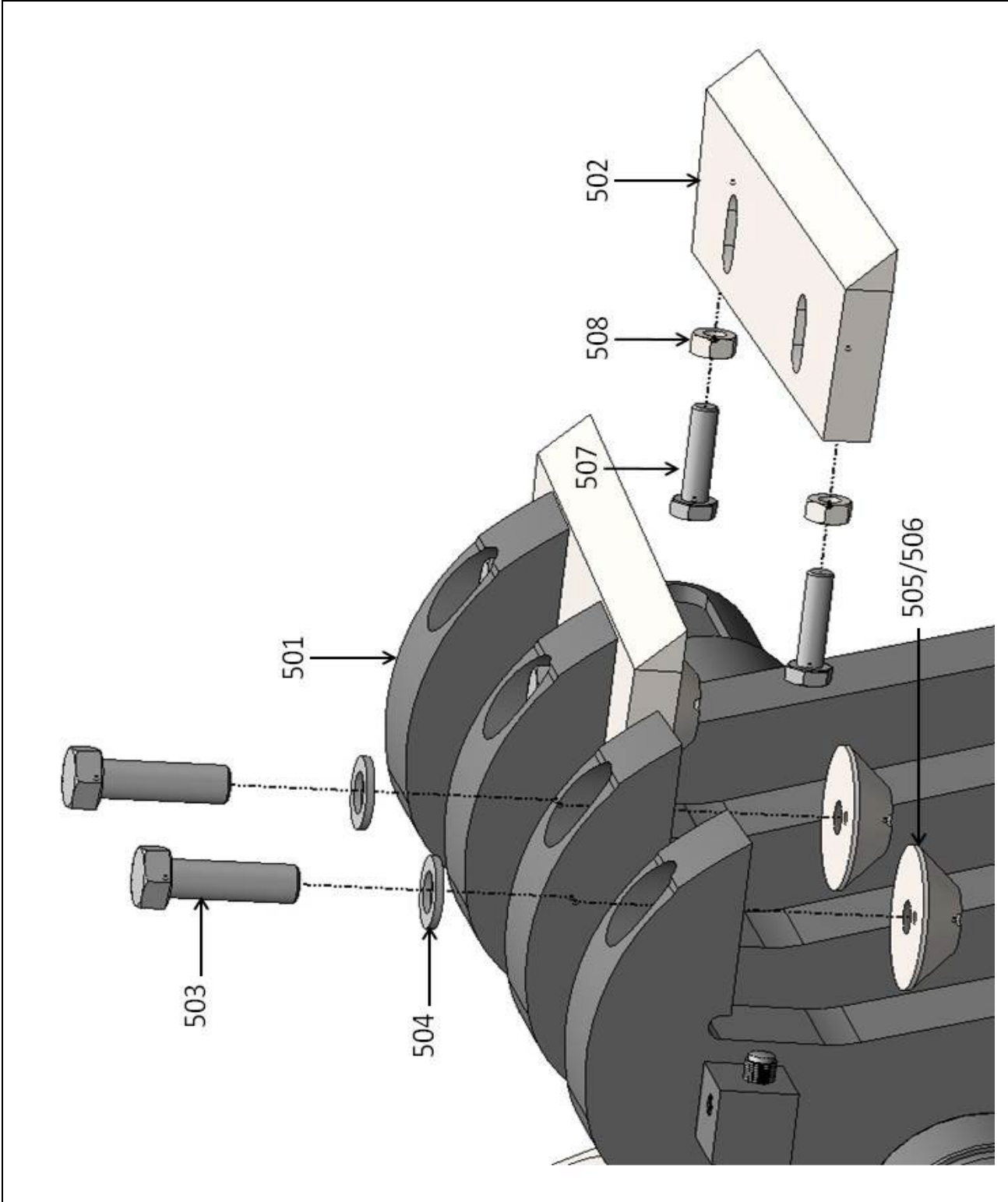

**ORIGINAL INSTRUCTION**  
**PART A: Basic machine**  
**Granulator C 40 Series**

Illustration: Rotor assembly 2

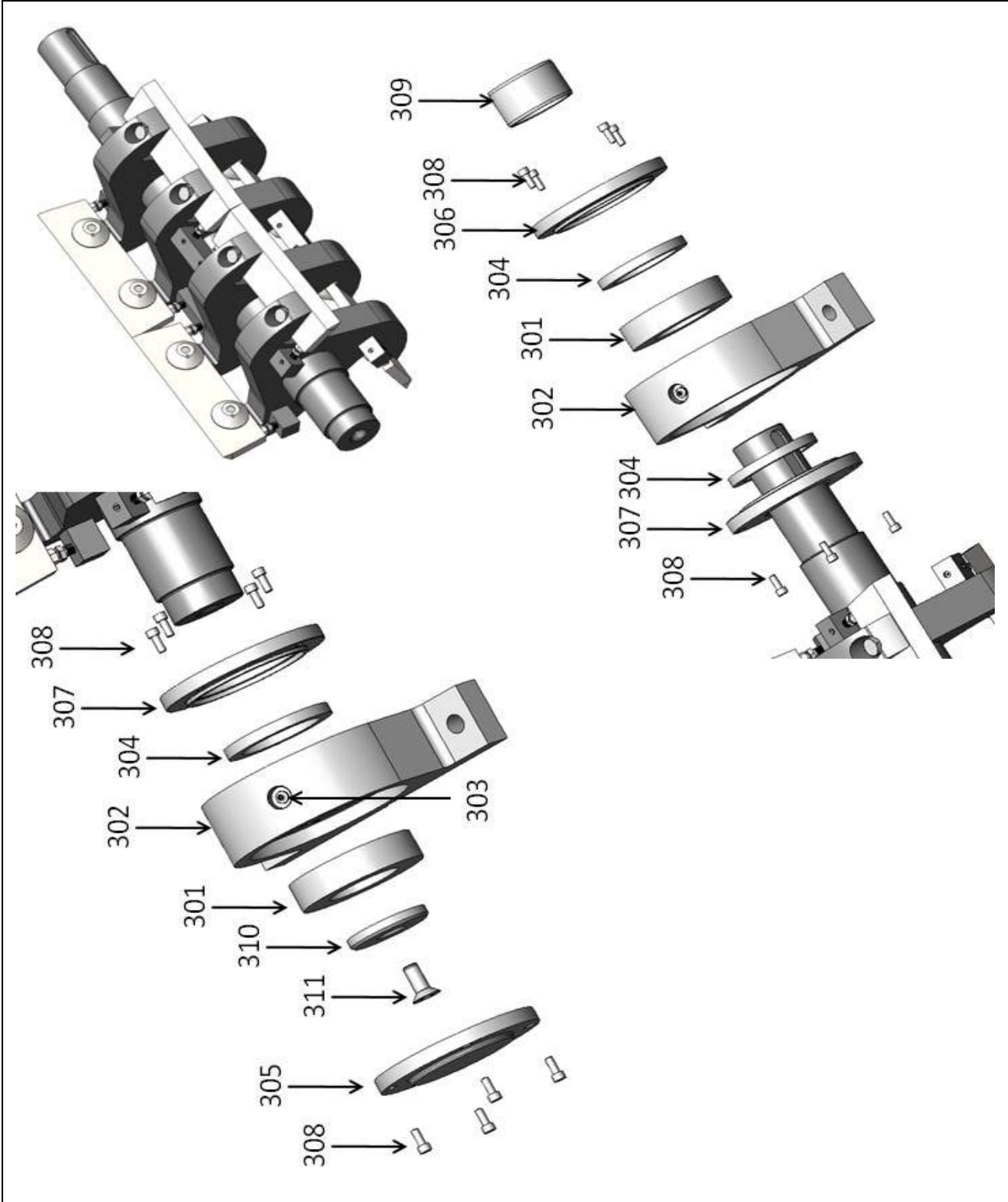



**ORIGINAL INSTRUCTION**  
**PART A: Basic machine**  
**Granulator C 40 Series**

Illustration: Stator knife assembly

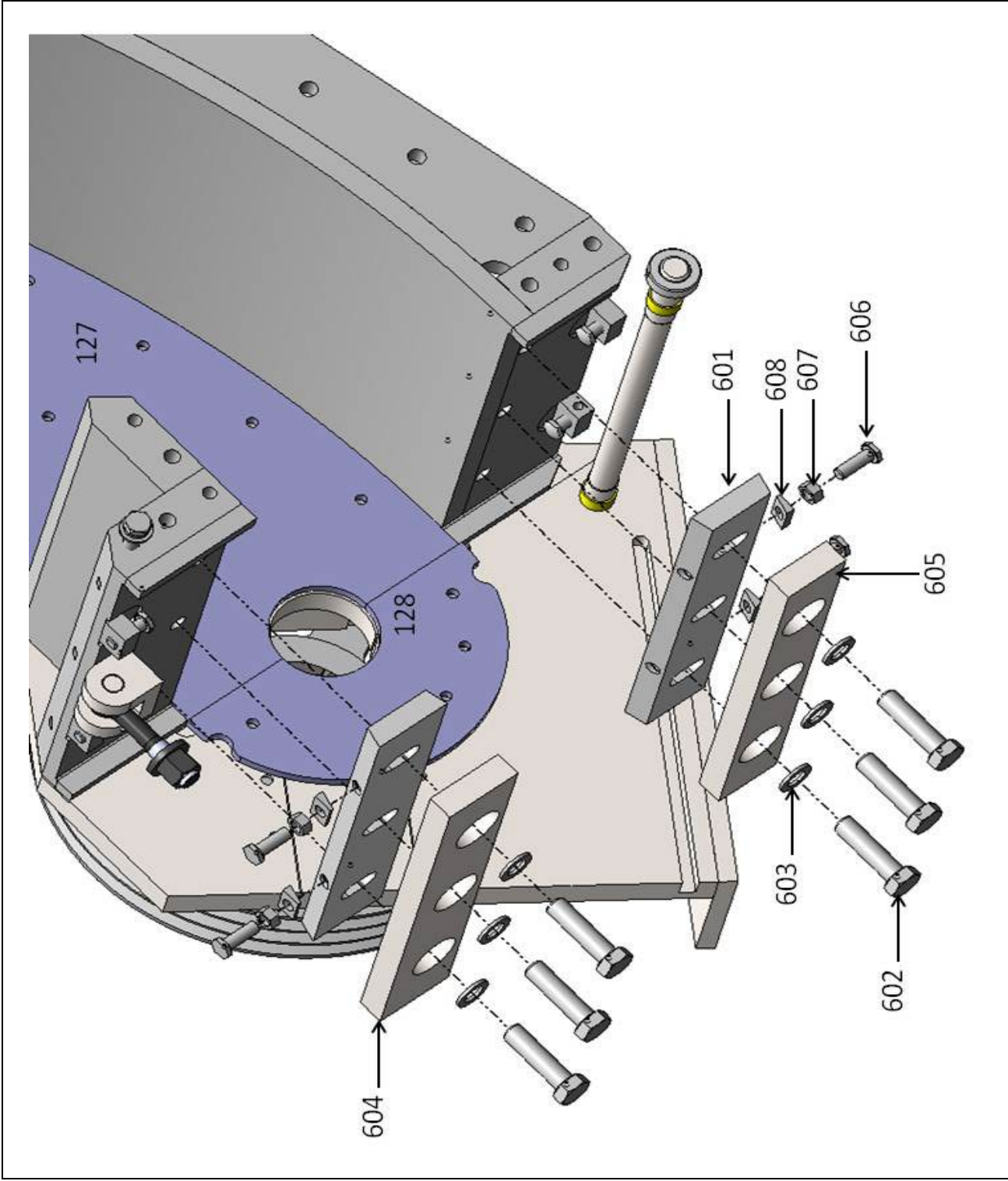

**ORIGINAL INSTRUCTION**  
**PART A: Basic machine**  
**Granulator C 40 Series**

---

**13 CLARIFICATION FOR PERSONAL TRAINING**

This is to certify that I have attended an in company training for service and operation of the granulator and understand all safety regulations. Further to this I have read and understand the owners' manual.

<b>City</b>	<b>Date</b>	<b>Printed name</b>	<b>Signature</b>

## **14 ELECTRICAL CONNECTION**

The machine should be wired by a qualified electrician.

Please refer to the wiring diagram.

**15        DIMENSIONS OF STANDARD MACHINE**

**15.1      C40/60**

**ORIGINAL INSTRUCTION**  
**PART A: Basic machine**  
**Granulator C 40 Series**

---

**15.2      C40/100**

**16      ADDITION**

Documentation Main Drive Granulator  
( PART B )  
Delivery documentation

**ATTENTION:**

**The wiring schematics are located in the control panel in the event that the control panel is a part of the delivery**



**Virtus Equipment**

9120 Centerlinks Commerce Dr., Unit 4  
Fort Myers, FL 33912

239-219-1500

Parts@Virtus-Equipment.com

[www.Virtus-Equipment.com](http://www.Virtus-Equipment.com)