

OPERATING MANUAL

G SERIES

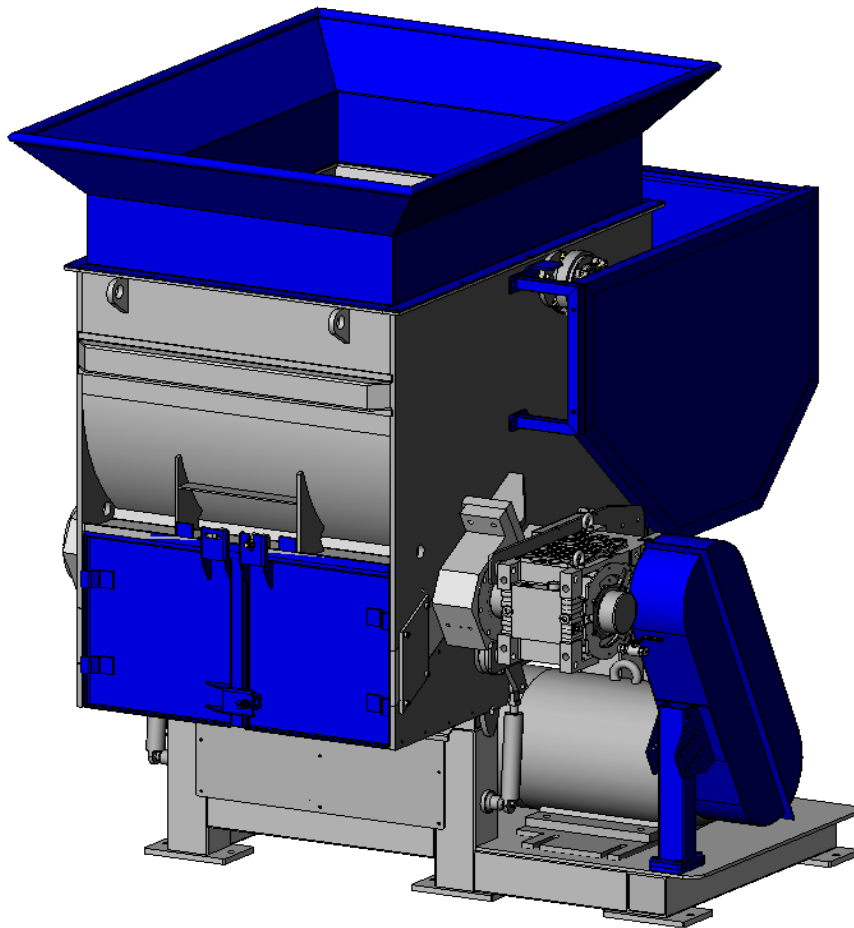

Virtus Equipment

9120 Centerlinks Commerce Dr., Unit 4
Fort Myers, FL 33912

239-219-1500

Parts@Virtus-Equipment.com

www.Virtus-Equipment.com

Virtus
Equipment

The Right Machine for Today's
Recycling Requirements

ORIGINAL INSTRUCTION
PART A: Basic machine
Shredder G Series

Table of Contents

1	Information on this instruction manual	6
2	Technical data	7
2.1	G 40-85	7
2.2	G 40-85+	8
2.3	G 45-120	9
2.4	G 45-150	10
2.5	G 45-200	11
3	General Information	12
3.1	Copyright	12
3.2	Application	12
3.3	Safety	12
3.4	Inspection of goods	12
4	General safety advice	13
4.1	Safe operation of the machine	13
4.2	Use in accordance with the regulations	14
4.3	Liability and Responsibility	17
4.4	Structural changes, spare parts, accessories	18
4.5	Operation manuals from other manufacturers	18
4.6	Noise levels and noise control measures	19
4.7	Work stations	19
4.8	Remaining risks	20
4.8.1	Mechanical dangers	20
4.8.2	Electrical dangers	21
4.8.3	Dangers caused by the control system	22
4.8.4	Thermal dangers	22
4.8.5	Dangers caused by noise	22
4.8.6	Dangers caused by vibration	22
4.8.7	Dangers caused by materials and substances	23
4.8.8	Danger caused by manipulation of the protective devices	23
4.9	Protective devices	24
4.9.1	Safety device for housing flap	24
4.9.2	"V"-belts and pusher protector	25
4.9.3	Safety markings	25
4.10	Authorized persons	26
4.11	Personal protective gear	27
4.12	Safety measures at the application site	28
4.13	Fire fighting agents	28
4.14	Cleaning agents	28
4.15	Conduct in case of an emergency	28

ORIGINAL INSTRUCTION
PART A: Basic machine
Shredder G Series

4.16 Classification of specific safety advice _____ **29**

5 Description of the machine _____ **30**

5.1 Functional description _____ **30**

 5.1.1 Mechanical section _____ 30

 5.1.2 Control _____ 30

5.2 Grinding material in feed _____ **31**

 5.2.1 In feed hopper _____ 31

 5.2.2 Additional in feed device _____ 32

 5.2.3 Cutting chamber monitoring device (optional) _____ 33

5.3 Machine (Standard execution) _____ **34**

5.4 Drive _____ **35**

5.5 Rotor, knives and screen _____ **36**

 5.5.1 Rotor and knives _____ 36

 5.5.2 Screen and screen support _____ 38

5.6 Discharge of grinding material _____ **39**

5.7 Hydraulic pusher _____ **40**

5.8 Control panel _____ **41**

 5.8.1 Pulse/Push function _____ 42

6 Initial startup _____ **43**

6.1 General Advice _____ **43**

6.2 Requirements at the application site _____ **44**

6.3 Unloading and installing the machine _____ **45**

6.4 Electrical connection _____ **46**

6.5 Machine check prior to initial start-up _____ **49**

7 Operation _____ **50**

7.1 Machine checks before switching on the machine _____ **50**

7.2 Switch on machine _____ **50**

7.3 Switch off machine _____ **51**

7.4 Manual in feed of grinding material _____ **51**

8 Maintenance _____ **52**

8.1 Safety advice _____ **52**

8.2 Maintenance plan _____ **52**

8.3 Checking the protective devices _____ **53**

8.4 Cleaning the machine _____ **54**

8.5 Replacing the gear box _____ **55**

8.6 Replacing the rotor _____ **55**

 8.6.1 Dismounting the rotor _____ 55

 8.6.2 Mounting the rotor _____ 56

8.7 Replacing the main bearings _____ **57**

 8.7.1 Dismounting the main bearings _____ 57

 8.7.2 Mounting the main bearing _____ 58

ORIGINAL INSTRUCTION
PART A: Basic machine
Shredder G Series

- 8.8 Lubricating the main bearings _____ 59**
 - 8.8.1 Lubrication intervals: _____ 59
 - 8.8.2 Check lubricant quality _____ 59
 - 8.8.3 Replacing or refilling lubricant _____ 59
 - 8.8.4 List of lubricants _____ 61
- 8.9 Mounting and dismounting TAPER-LOCK tensioning element _____ 62**
 - 8.9.1 Table for the tightening torque of the screws _____ 62
 - 8.9.2 Mounting the TAPER-LOCK tensioning element _____ 63
 - 8.9.3 Dismounting the TAPER-LOCK tensioning element _____ 63
- 8.10 Changing the screen _____ 64**
- 8.11 Work on the "V"-belts _____ 66**
 - 8.11.1 Checking the tension force of the "V"-belt _____ 66
 - 8.11.2 Retensioning and relaxing the "V"-belt _____ 67
 - 8.11.3 Checking "V"-belt condition, replacing "V"-belt _____ 67
- 8.12 Working on the cutting knives _____ 68**
 - 8.12.1 Replacing and checking the cutting knife mountings _____ 68
 - 8.12.2 Checking the condition of the cutting knives _____ 69
 - 8.12.3 Dismounting the rotor knives _____ 70
 - 8.12.4 Dismounting the rotor knife holders _____ 71
 - 8.12.5 Dismounting the stator knives _____ 73
 - 8.12.6 Mounting the rotor knife holders _____ 74
 - 8.12.7 Mounting the rotor knives _____ 75
 - 8.12.8 Mounting the stator knives _____ 76
 - 8.12.9 Sharpening cutting knives _____ 78
 - 8.12.10 Setting the cutting knives _____ 79
 - 8.12.11 Transporting and storing the cutting knives _____ 80
- 9 Troubleshooting _____ 81**
 - 9.1 Machine blocks or switches itself off _____ 81**
 - 9.2 Rotor does not grip bulky material _____ 81**
 - 9.3 Overheating of the grinding material _____ 81**
 - 9.4 Unusual vibrations _____ 81**
 - 9.5 Extreme cutter wear _____ 82**
 - 9.6 Bearings too hot _____ 82**
 - 9.7 Too many fines in grinding material _____ 82**
 - 9.8 Cutting gap alters during operation _____ 82**
 - 9.9 Screen damage _____ 82**
 - 9.10 Shredder does not start _____ 82**
 - 9.11 Shredder blocks when under load _____ 83**
 - 9.12 Frequent switching off of grinding material in feed device _____ 83**
 - 9.13 Pusher does not work _____ 83**

ORIGINAL INSTRUCTION
PART A: Basic machine
Shredder G Series

10 Storage, disposal, transportation _____ 84
10.1 Storage _____ 84
10.2 Disposal _____ 84
10.3 Transportation _____ 84
11 Hydraulic Maintenance _____ 85
12 Customer service and spare parts orders _____ 88
13 Spare Parts Lists _____ 89
13.1 G 40-85 _____ 89
13.2 G 40-85+ _____ 92
13.3 G 45-120 _____ 95
13.4 G 45-150 _____ 98
13.5 G 45-200 _____ 101
14 hydraulic Units _____ 110
14.1 SHC-196I for G 40-85/ 45-85+ _____ 110
14.2 SHC-182H for G 45-120/1500/2000 _____ 111
15 Clarification for Personal Training _____ 112
16 Electrical Connection _____ 113
17 Dimensions Of Standard Machine _____ 114
17.1 G 40-85 _____ 114
17.2 G 40-85+ _____ 115
17.3 G 45-120 _____ 116
17.4 G 45-150 _____ 117
17.5 G 45-200 _____ 118
18 ADDITION _____ 119

1 INFORMATION ON THIS INSTRUCTION MANUAL

Author: VIRTUS EQUIPMENT

No part of this operation manual may be reproduced, distributed or used in any shape or form, stored in a data processing system or translated into another language without written permission.

This operation manual serves to help you to get to know your machine and how to make use of its application possibilities in accordance with the regulations.

The operation manual contains important information on how to operate the machine safely, correctly and economically. Following this advice will help you to avoid danger, minimize repair costs and down times and to increase the reliability and durability of the machine.

Before you begin to work on and with the machine, please read the operation manual thoroughly. Only after you have read and understood the contents of this operation manual may you begin work on and with the machine. Keep this operation manual at the application site for future reference.

References to chapters, plans and other documents as well as key markings are written in *italics*.

↓ Instructions on handling are marked in this way.

The machine is designed in modular system and offers a wide spectrum of variations to do justice to your expectations.

This operation manual is divided into three parts:

1. Part A: Information of the basic machine.
2. Part B: Plans, operation manuals for systems from other manufacturers etc.

Should you wish to order further operation manuals, please quote the machine number.

We wish you every success with your new machine!

ORIGINAL INSTRUCTION
PART A: Basic machine
Shredder G Series

2 TECHNICAL DATA

2.1 G 40-85

Feeding chamber opening:	Data in mm:	860x1400
Rotor dimension:	Diameter in mm:	387
	Width of cut in mm:	850
Rotor type E		
Rotor knives:	No. of rotor knives:	40/60
Stator knives:	No. of stator knives:	3
	Rows of stator knives:	1x3
Rotor speed (50 Hz):	rpm	74
Width:	Data in mm:	1939
Length:	Data in mm:	2330
Height:	Data in mm:	2450
Drive motor:	Power in kW:	37
Motor hydraulic unit:	Power in kW:	3.75
Screen:	Type and screen hole size dependent on the application and customer requirements.	Hydraulic opening of screen holder
Machine weight:	In kg	Approx. 4340
Electrical connection data:	markings are attached to the machine	
Noise level: Depends on plant location and type of grinding material!	Without noise equipment, in dB(A):	Approx. 95
	With noise equipment in dB(A):	depends on type of soundproof
Dimensions:	See Layout <i>drawing</i>	

ORIGINAL INSTRUCTION
PART A: Basic machine
Shredder G Series

2.2 G 45-85+

Feeding chamber opening:	Data in mm:	1590x850
Rotor dimension:	Diameter in mm:	457
	Width of cut in mm:	860
Rotor type E		
Rotor knives:	No. of rotor knives:	40/60
Stator knives:	No. of stator knives:	3
	Rows of stator knives:	1x3
Rotor speed (50 Hz):	rpm	74
Width:	Data in mm:	1980
Length:	Data in mm:	2300
Height:	Data in mm:	2600
Drive motor:	Power in kW:	55
Motor hydraulic unit:	Power in kW:	3.75
Screen:	Type and screen hole size dependent on the application and customer requirements.	Hydraulic opening of screen holder
Machine weight:	In kg	Approx. 5500
Electrical connection data:	markings are attached to the machine	
Noise level: Depends on plant location and type of grinding material!	Without noise equipment, in dB(A):	Approx. 95
	With noise equipment in dB(A):	depends on type of soundproof
Dimensions:	See Layout <i>drawing</i>	

ORIGINAL INSTRUCTION
PART A: Basic machine
Shredder G Series

2.3 G 45-120

Feeding chamber opening:	Data in mm:	1140x1610
Rotor dimension:	Diameter in mm:	457
	Width of cut in mm:	1130
Rotor type E		
Rotor knives:	No. of rotor knives:	54/81
Stator knives:	No. of stator knives:	4
	Rows of stator knives:	1x4
Rotor speed (50 Hz):	rpm	74
Width:	Data in mm:	2270
Length:	Data in mm:	2450
Height:	Data in mm:	2540
Drive motor:	Power in kW:	55
Motor hydraulic unit:	Power in kW:	5.6
Screen:	Type and screen hole size dependent on the application and customer requirements.	Manual opening of screen holder
Machine weight:	In kg	Approx. 5780
Electrical connection data:	markings are attached to the machine	
Noise level: Depends on plant location and type of grinding material!	Without noise equipment, in dB(A):	Approx. 95
	With noise equipment in dB(A):	depends on type of soundproof
Dimensions:	See Layout <i>drawing</i>	

ORIGINAL INSTRUCTION
PART A: Basic machine
Shredder G Series

2.4 G 45-150

Feeding chamber opening:	Data in mm:	1420x1610
Rotor dimension:	Diameter in mm:	457
	Width of cut in mm:	1410
Rotor type E		
Rotor knives:	No. of rotor knives:	68/102
Stator knives:	No. of stator knives:	5
	Rows of stator knives:	1x5
Rotor speed (50 Hz):	rpm	74
Width:	Data in mm:	2590
Length:	Data in mm:	2450
Height:	Data in mm:	2540
Drive motor:	Power in kW:	75
Motor hydraulic unit:	Power in kW:	5.6
Screen:	Type and screen hole size dependent on the application and customer requirements.	Manual opening of screen holder
Machine weight:	In kg	Approx. 6770
Electrical connection data:	markings are attached to the machine	
Noise level: Depends on plant location and type of grinding material!	Without noise equipment, in dB(A):	Approx. 95
	With noise equipment in dB(A):	depends on type of soundproof
Dimensions:	See Layout <i>drawing</i>	

ORIGINAL INSTRUCTION
PART A: Basic machine
Shredder G Series

2.5 G 45-200

Feeding chamber opening:	Data in mm:	1980x1610
Rotor dimension:	Diameter in mm:	457
	Width of cut in mm:	1970
Rotor type E		
Rotor knives:	No. of rotor knives:	96/144
Stator knives:	No. of stator knives:	7
	Rows of stator knives:	1x7
Rotor speed (50 Hz):	rpm	74
Width:	Data in mm:	3710
Length:	Data in mm:	2450
Height:	Data in mm:	2540
Drive motor:	Power in kW:	2x55
Motor hydraulic unit:	Power in kW:	5.6
Screen:	Type and screen hole size dependent on the application and customer requirements.	Manual opening of screen holder
Machine weight:	In kg	Approx. 8930
Electrical connection data: markings are attached to the machine		
Noise level: Depends on plant location and type of grinding material!	Without noise equipment, in dB(A):	Approx. 95
	With noise equipment in dB(A):	depends on type of soundproof
Dimensions:	See Layout <i>drawing</i>	

3 GENERAL INFORMATION

3.1 Copyright

VIRTUS EQUIPMENT and related parties holds the copyright for these operation instructions, entrusted to the owner of the shredder for his personal use. This contains technical instructions and drawings which are not be copied complete or in part, distributed or used for reasons of unauthorized competition or for informing others.

3.2 Application

The shredder is designed for size-reduction of plastic material such as PE, PP, and PVC etc. The user is responsible for consequences resulting from incorrect operation: This will lead to the loss of the warranty as well as any compensation claims.



3.3 Safety

The shredder has been constructed in accordance to the general standards of technology and is fitted with safety devices to prevent accidents that could endanger the life or health of the operator. The company operating the unit is responsible for the compliance to the safety regulations. We recommend staff training courses at regular intervals subsequent to initial training during commissioning.

3.4 Inspection of goods

The goods must be inspected by the purchaser to ensure that the delivery is complete and free from damage during transport. In the event of any queries VIRTUS must be informed with regard to missing items or transport damage. In the event of actual transport damage, written notification including photographs should be made and sent to the transport company as well as sent to VIRTUS immediately after delivery.

4 GENERAL SAFETY ADVICE

 WARNING	
	<p>The partly completed machinery must not be put into service until the final machinery into which it is to be incorporated has been declared in conformity with the provisions of Directive 2006/42/EC on Machinery, where appropriate, and until the EC Declaration of Conformity according to Annex II A is issued.</p>

4.1 Safe operation of the machine

The machine is built according to the state of the art and recognised safety regulations.

It is equipped with protective devices; however there is still the threat of danger in case of incorrect conduct or misuse:

- for the health of the operator and that of other persons,
- for the machine,
- for the environment,
- for material assets belonging to the company and the operator.

All persons involved in:

- transportation and storage,
- start-up and shutdown,
- operation,
- setting and fitting
- maintenance and waste disposal...

of the machine must carefully read and take note of the following advice. However, not only does the general safety advice listed in this chapter need to be observed, but also the safety advice which is added specifically in the other chapters.

Failure to heed this safety advice can lead to loss of all compensation claims.

Furthermore, the existing rules and regulations for the prevention of accidents as well as in house company working, operational and safety regulations have to be observed.

ORIGINAL INSTRUCTION
PART A: Basic machine
Shredder G Series

4.2 Use in accordance with the regulations

The operational safety of the delivered machine is only guaranteed for use in accordance with the regulations!
This regulation use is only achieved if the following points are observed and fulfilled.

Manufacturing process and grinding material

The shredder is suitable exclusively for the shredding of material, which corresponds to the agreed customer-specific specifications in all points (see *Contract of sale*).

Any other work or design will differ from the specified requirements. VIRTUS EQUIPMENT will not be held responsible. The specified requirements also include all information found in the owner’s manual such as maintenance and service. Any change in the specifications or requirements must be brought to the attention of VIRTUS.

Discharge device

The shredder must be operated with a suitable discharge device, such a belt conveyor or discharge screw.



 WARNING	
	The machine is not allowed to run without suitable discharge device!

Safety device for the in feed hopper

The shredder must be operated with a suitable feeding device, such a belt conveyor, loading crane or feeding screw.

 WARNING	
	The machine is not allowed to run with manual material feed!

ORIGINAL INSTRUCTION
PART A: Basic machine
Shredder G Series

 WARNING	
	The shredder shall be installed so that no items can be thrown out of the discharge area causing hazards!

Connection of the Emergency Stop button

The machine may only be operated with the installed Emergency Stop buttons. In case no Emergency Stop buttons have been installed, an Emergency Stop button must be mounted on the control cabinet, the second on the material in feed.

Miscellaneous:

- The working conditions and instructions specified in this operation manual must be adhered to.
- The machine is not suitable for operation in an explosive environment.
- Faults, which can impair safety, are to be reported immediately and eliminated by a trained and skilled specialist.
- The machine may only be used in the industrial application range.

General Requirements Safety Information

- The service and maintenance in this owner's manual must be performed on a regular basis.
- The machine is not designed for operation in a volatile environment.
- Faults that could be a safety hazard must be reported immediately and repaired by experienced personal.
- The machine must only be installed in an industrial type building.

Known uses not in accordance with the regulations

Never shred materials, which do not correspond to the agreed customer-specific specifications. If this occurs, there could be a danger to persons and the possibility of the machine being damaged.

ORIGINAL INSTRUCTION
PART A: Basic machine
Shredder G Series

Informal Safety Requirements

The owner's manual should always be located near the machine. New excerpts or additions to the owners' manual must always be inserted to include any safety requirements or environmental requirements.

All safety or caution signs must be visible and easy to read.

4.3 Liability and Responsibility

The General Conditions of Sale and Delivery apply. These conditions apply no later than the end of the contract. Liability and or responsibility to seller do not apply to the following;

- Equipment is not properly used for its specific application.
- Non-conforming installation, commissioning or service of the machines.
- Operation of the equipment without proper safety guards.
- Not conforming to the directions of the owners' manual regarding transport, storage, installation, commissioning or servicing the equipment.
- Any designs alterations on the machine.
- Any changes on the program logic which can alter the machine operation or electrical function.
- Changes in the logic function.
- Improper maintenance or servicing of the machines that can lead to extraordinary wear
- Improper servicing of equipment
- Spontaneous crashes caused by foreign objects falling into the machine or acts of God

We honour a 12 month guarantee valid after delivery under the conditions that originally delivery or original parts from VIRTUS EQUIPMENT are used or accepted for use in accordance with our owner's manual.

Otherwise the guarantee will be considered invalid. Excluded are wear and tear parts such as knives, screens, drive belts, bearings, etc.

4.4 Structural changes, spare parts, accessories

For reasons of safety, remodelling and/or modifications to the machine, in particular to the electrical devices, are only permissible by arrangement with the manufacturer!

Replace faulty parts immediately. Only use original spare parts or spare parts from other manufacturers, which correspond to the original spare parts with regards to function, stress and safety. This applies in particular for reasons of EMC (electro-magnetic compatibility) for electrical components.

The use of unsuitable parts can impair resistance to relays and increase the emission of relays!

If parts are replaced which are relevant for safety, they must be checked afterwards for proper function.

Only use accessories, which have been approved by the manufacturer. Use of accessories can change how the machine works. You must therefore observe the additional advice for your work and your safety. Read *Part B: Accessories*, before you commission the machine.

4.5 Operation manuals from other manufacturers

Integrated in the machine are systems from other manufacturers. When working on or with these systems, please observe the advice in the operation manuals from the respective manufacturer. These operation manuals are enclosed with the machine documentation.

ORIGINAL INSTRUCTION
PART A: Basic machine
Shredder G Series

4.6 Noise levels and noise control measures

The G series shredder standard design is without a sound proof enclosure.

The noise level of the shredder at idle speed is approximately 85 dB (A).

Especially by rigid materials soundproofing is recommended due to a noise level of up to 120 dB (A) when in operation.

In order not to exceed the noise level of 85 dB (A) is the purchaser required to provide soundproofing.

The noise level can be affected by foundation static or dynamic, aux. blowers etc. or other additional equipment. Therefore it is necessary to actually determine if the noise level is directly coming from the machine or accessory equipment.

VIRTUS Machinery & Recycling Technology offers the following equipment to reduce the noise levels:

- Walk-in type soundproof enclosure.



CAUTION

The user or purchaser is responsible for compliance with the instructions and procedures!

4.7 Work stations

During normal operation, the work station is the station at the in feed of the grinding material.

For maintenance work, the whole area around the machine is at your disposal.

ORIGINAL INSTRUCTION
PART A: Basic machine
Shredder G Series

4.8 Remaining risks

The machine is constructed so that you are able to operate it safely. Structurally non-avoidable dangers are prevented as well as possible by the protective devices. A certain remaining risk does however always remain! Being aware of these remaining risks of the machine will help you to structure your work more safely and in so doing to avoid accidents.

To avoid danger, please observe in addition the specific safety advice in the individual chapters.

4.8.1 Mechanical dangers

Type of danger:	Danger of crushing by heavy parts falling down or falling over.
Activity:	Unloading and transporting the machine or machine components.
Possible consequences:	Serious injury could result.
Preventative measures:	Wear personal protective gear. Follow the instructions in this <i>Operation manual</i> .

Type of danger:	Danger of cutting caused by sharp cutting knives, even when the rotor is stationary.
Activity:	Knife replacement, knife setting, and knife sharpening, other maintenance work.
Possible consequences:	Serious injury, particularly to hands and fingers can result.
Preventative measures:	Wear personal protective gear. Follow the instructions in this <i>Operation manual</i> .

Type of danger:	Danger of crushing when opening/closing the maintenance doors on the front side of the machine.
Activity:	Maintenance work.
Possible consequences:	Serious injury can result.
Preventative measures:	Ensure that no persons are in the danger area while closing the door.

Type of danger:	Tripping over cables and other objects lying around.
Activity:	All activities.
Possible consequences:	Serious injury can result.
Preventative measures:	Lay cables in accordance with the regulations. Keep work station clean and tidy.

ORIGINAL INSTRUCTION
PART A: Basic machine
Shredder G Series

Type of danger:	Danger of crushing, cutting and amputation caused by run down of the rotor.
Activity:	Maintenance work.
Possible consequences:	Serious injury or death can result.
Preventative measures:	The maintenance doors must always be tightly locked during operation. Do not make the run down safety devices ineffective by using technical aids or other manipulations. Never check by hand whether the rotor has come to a stop.

Type of danger:	Danger of pulling in caused by running "V"-belts.
Activity:	All activities.
Possible consequences:	Hair, jewellery etc. can be pulled into the machine. Serious injury can result.
Preventative measures:	Never dismount "V"-belt protection and window.

4.8.2 Electrical dangers

Danger:	Direct or indirect contact with live parts in the terminal box.
Activity:	Maintenance work, start-up.
Possible consequences:	Serious injury or death.
Preventative measures:	Only trained electricians may only carry out all work on the electrical equipment. If work is necessary on parts, which conduct dangerous voltage, a second person should be called in who can break the power supply in case of emergency. The yellow-marked lines conduct voltage even when the machine is switched off (main switch to 0). Only use original safety fuses with stipulated intensity of current. Faulty electrical components must be replaced immediately. If faults occur in the electrical energy supply, switch machine off immediately. The terminal box must be locked during operation. Before opening the terminal box: Main switch to 0.

ORIGINAL INSTRUCTION
PART A: Basic machine
Shredder G Series

4.8.3 Dangers caused by the control system

Type of danger:	Danger caused by failure of the Emergency Stop function.
Activity:	All activities.
Possible consequences:	Serious injury or death.
Preventative measures:	It must be guaranteed that failure of an Emergency Stop button is displayed and leads to an immediate stop of the machine.

4.8.4 Thermal dangers

Type of danger:	Danger of fire and explosion caused by throwing dangerous objects (e.g. spray cans) into the shredder.
Activity:	Grinding.
Possible consequences:	Serious injury or death can result.
Preventative measures:	Only grind material which corresponds to the agreed customer-specific specifications in all points.

4.8.5 Dangers caused by noise

Type of danger:	Damage to hearing.
Activity:	All activities.
Possible consequences:	Diminished hearing, headaches, impaired balance, and deterioration of concentration.
Preventative measures:	Reduce noise emissions by taking suitable measures. Wear ear protection.

4.8.6 Dangers caused by vibration

Type of danger:	Instability of the machine caused by vibration.
Activity:	All activities.
Possible consequences:	Serious injury can result.
Preventative measures:	Install the machine according to the instructions of this <i>Operation manual</i> and the <i>Assembly drawing</i> .

ORIGINAL INSTRUCTION
PART A: Basic machine
Shredder G Series

Type of danger:	Loosening of the cutting knife mountings caused by vibration.
Activity:	All activities.
Possible consequences:	Serious injury can result.
Preventative measures:	Check the cutting knife mountings regularly according to the instructions in this operation manual.

4.8.7 Dangers caused by materials and substances

Type of danger:	Inhalation of grinding dust.
Activity:	All activities.
Possible consequences:	Diseases of the respiratory tract etc.
Preventative measures:	Mount a suitable air suction device. Wear breathing equipment if necessary. When cleaning the machine do not blow out grinding dust, use suction instead.

4.8.8 Danger caused by manipulation of the protective devices

Type of danger:	Danger of crushing, cutting and amputation.
Activity:	All activities.
Possible consequences:	Serious injury or death can result.
Preventative measures:	Never make the protective devices ineffective. Check the protective devices regularly for proper functioning according to the specifications given in this operation manual.

ORIGINAL INSTRUCTION
PART A: Basic machine
Shredder G Series

4.9 Protective devices

The machine may under no circumstances be operated without these protective devices or with faulty or manipulated protective devices.

4.9.1 Safety device for housing flap

Illustration:
Safety device for
housing flap G 40-85



Illustration:
Safety device for
housing flap G 45-
120/1500/2000

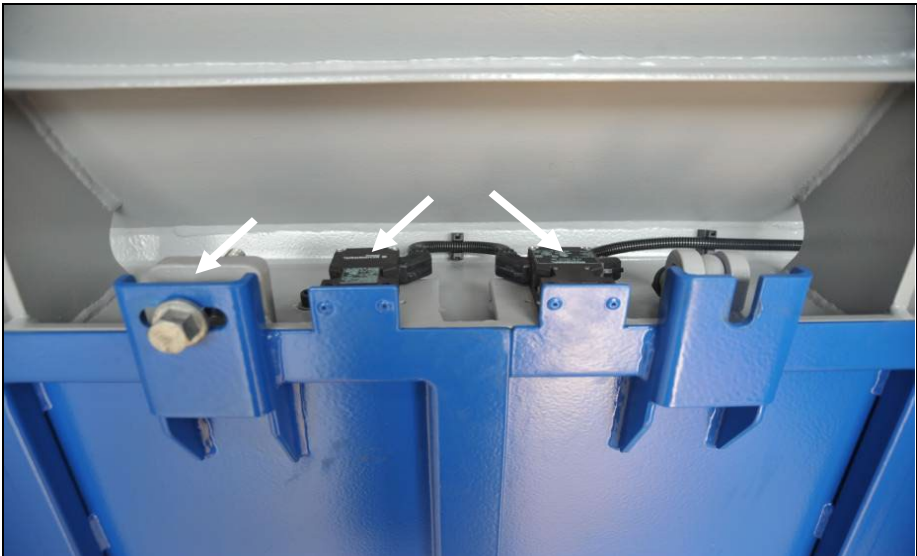

The shredder can only be operated if the housing flap is closed thus deactivating the safety switch. If the housing flap is opened, the contact is broken.

If the housing flap will be opened during operation, the safety switch is activated, thus switching off the machine.

ORIGINAL INSTRUCTION

PART A: Basic machine

Shredder G Series

4.9.2 "V"-belts and pusher protector

"V"-belt and pusher protection are fixedly connected to the machine. They can be dismantled for installation and maintenance work. However, this may only then be carried out when all rotating parts have come to a complete standstill.

Illustration:
V-belt cover
Pusher cover



If machines are delivered on the request of the customer without drive motors, the operator is obliged to fit and mount the protective devices delivered together with the machine himself in line with the current legal safety regulations.

CAUTION



All screws at the V-belt cover are safety screws which are mounted to the upper part! When disabling the cover, all screws must be losing at the same time. Otherwise damage could result!

4.9.3 Safety markings

Safety markings are attached to the machine. If one of these markings becomes detached or is no longer recognisable, it must be replaced. You can order new markings at specialist shops or from us.

4.10 Authorized persons

Only authorized personnel may only carry out work on the machine. Observe the legally permissible minimum age!

As a basic rule, only persons who have received training on the machine may only operate the machine.

Personnel, who are still to be trained or receive instruction on the machine, may only work on the machine under constant supervision by an experienced person.

The company operating the machine must make the operation manual accessible to the machine user and ensure that he has read and understood it. Only then may he put the machine into operation.

Responsibility for the different jobs on the machine must be clearly established and adhered to. There must be no unclear areas of authority, as this could endanger the safety of the machine user.

If several persons work on the machine, a detailed division of workstations should be set up.

Only trained electricians may only carry out all work on the electrical equipment.

Only authorized specialist personnel may only eliminate faults on the control system.

All work related to installation, only trained specialist personnel having received instruction on the machine might only carry out fitting and maintenance of the machine.

The operator must make sure that only authorized personnel work on the machine. The operator is responsible for the safety of third persons in the working area of the machine.

ORIGINAL INSTRUCTION
PART A: Basic machine
Shredder G Series

4.11 Personal protective gear

Wear close-fitting clothing. Jewellery and hair must be worn so that they cannot be pulled into the machine by moving parts.

The following protective gear must be worn when carrying out the following tasks:

	Safety helmet	Safety boots	Safety gloves	Safety goggles	Ear muffs
Unloading machine.	x	x	x		
Connecting machine.		x			
Operation.		x	x	x	x
Cleaning.		x	x	x	
Maintenance of bearings.		x			
Screen replacement.		x	x		
Maintenance of "V"-belts.		x			
Maintenance of cutting knives.		x	x		
Knife sharpening.		x	x	x	x

If necessary, protect yourself with breathing equipment (in addition to the air suction device) before inhaling substances harmful to the health.

4.12 Safety measures at the application site

Requirements at the application site: see chapter *Initial Start-up*.
The machine must be erected horizontally on a horizontal surface and in a stable manner.

Ensure by means of appropriate in house orders and controls that the environment of the work station is always clean and clear of obstructions.

4.13 Fire fighting agents

In the case of fire, disconnect the power supply of the machine or pull out the mains plug. Extinguish the fire from a distance of several meters using a fire extinguisher suitable for the machine and the grinding material.

4.14 Cleaning agents

Only use suitable cleaning agents to clean the machine and in doing so, the advice of the manufacturer is to be heeded. Please be aware that unsuitable cleaning agents (e.g. thinners) can damage the paint of the machine as well as the cables and plastic parts.

4.15 Conduct in case of an emergency

The machine may only be operated with the installed Emergency Stop buttons. An Emergency Stop button must be mounted onto the control cabinet, the second onto the grinding material in feed.

Emergency Stop:

- ↓ In case of emergency, immediately press one of the *Emergency Stop buttons*.

CAUTION

The EMERGENCY STOP must be activated in all situations whereby injury or damage could result!







Reoperation:



- ↓ Eliminate cause of Emergency Stop.
- ↓ Unlock *EMERGENCY STOP BUTTON*.
- ↓ Acknowledge fault.
The machine is now ready for operation again.

4.16 Classification of specific safety advice

The specific safety advices in the following chapters of this operation manual are classified as follows:

 DANGER	
	Indicates an immediately threatening danger. If you do not take avoiding action, death or serious injury will result.

 WARNING	
	Indicates a possibly dangerous situation. If you do not take avoiding action, death or serious injury could result.

 CAUTION	
	Indicates a possibly dangerous situation. If you do not take avoiding action, slight or minor injury could result.

This safety advice refers to the remaining risks for certain working steps and helps you to work safely with the machine. In addition to the safety advice above, there are also the hint and the tip.

HINT



Indicates a possibly harmful situation. If you do not take avoiding action, the machine could be damaged.

TIP



Indicates application tips and other particularly useful information.

5 DESCRIPTION OF THE MACHINE

5.1 Functional description

5.1.1 Mechanical section

After the machine has been switched on, a hydraulically controlled feeding unit pushes a quantity of material onto the slow-running profiled rotor. The in feed is controlled according to load.

The material can be placed unsorted in the hopper mounted on top of the machine. Attention must be paid that this material does not contain **any other metal parts** apart from staples and nails. The guarantee does not cover any damage to the machine as a result of metal parts being fed into the machine. The material in the hopper is shredded by the rotating knives on the rotor. This shredding process is repeated as often as required until the diameter of the sieve behind the rotor has been reached.

The shredder can also be switched off with material still in the hopper.

5.1.2 Control

The machine is fitted with an automatic shutdown, i.e. when set to automatic; the machine switches off after a period which has been preset in the time relay.

The pusher feeds the shredding unit (rotor) with as much material as it is able to process. Upon reaching 70-90 % of rated current, the feeding of the pusher will be stopped and automatically started again after the power consumption has fallen by 20 % in comparison with rated current. If the high current is applied for longer than 0.7 - 1.5 sec., the main drive motor switches off and runs back after about 3 sec. standstill time. The pusher plate also runs back whilst the rotor runs back. The drive motor then stops for another 3 sec. before starting again.

Duration of pauses and return as well as the current settings can be adjusted.

Any alterations, however, should only be carried out after consulting the manufacturer.

5.2 Grinding material in feed

The grinding material can be fed into the shredder in the following ways:

- Manual in feed of the grinding material with the help of an additional in feed device (e.g. hydraulic feeding unit).
- Automatic in feed of the grinding material by means of an additional in feed device (e.g. conveyor belt).

CAUTION



Filaments, tape and film shall, be cut in advance into short pieces or collected in batches before feeding, so as to avoid the risk of entanglement

5.2.1 In feed hopper

The grinding material in feed ensues via an in feed hopper, which is formed so that the grinding material can be delivered correctly and safely.

Illustration:

Standard hopper



Optional (not included in standard machine) the in-feed hopper can be equipped with an optional top hinged cover to prevent in-feed material fly out during the size reduction process.

ORIGINAL INSTRUCTION
PART A: Basic machine
Shredder G Series

Illustration:

Special hopper with hydraulic cover



5.2.2 Additional in feed device

If your machine has an optional in feed device such as a conveyor belt please refer to the additional information about the accessories in the appendix.
For in feed with conveyor belt we can supply a special hopper.

Illustration:

Hopper for Conveyor belt in feed

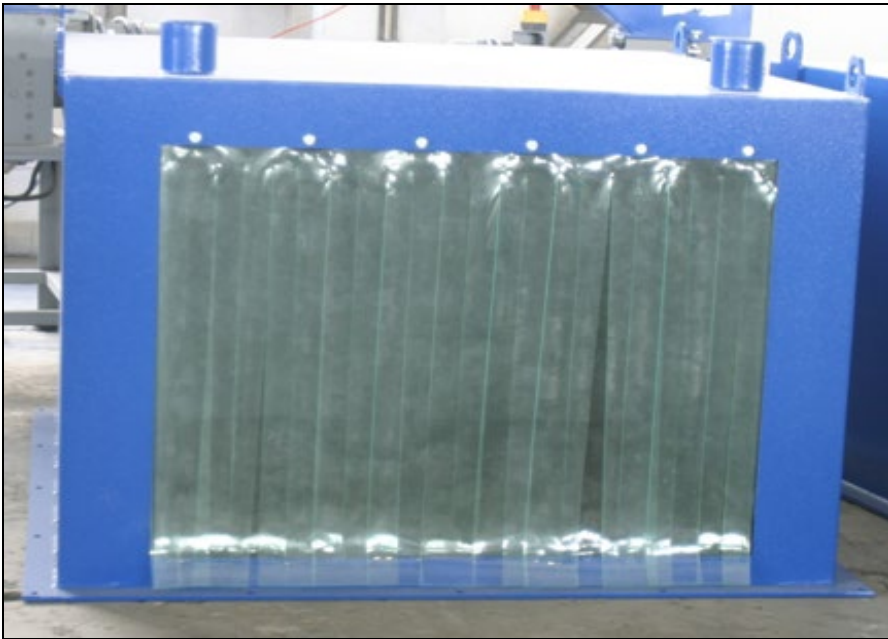

ORIGINAL INSTRUCTION
PART A: Basic machine
Shredder G Series

5.2.3 Cutting chamber monitoring device (optional)

The G can be equipped with a monitoring device, which allowed the operator to check inside the cutting chamber.

Optional monitoring devices:

- Mirror
- Video camera

Illustration:

Standard hopper with mirror

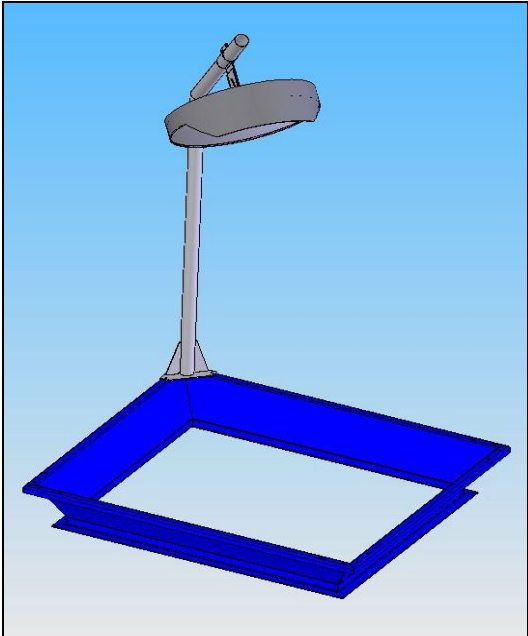

The monitoring device can be placed in each of the 4 corner of the standard hopper.

Illustration:

Mirror mounting position

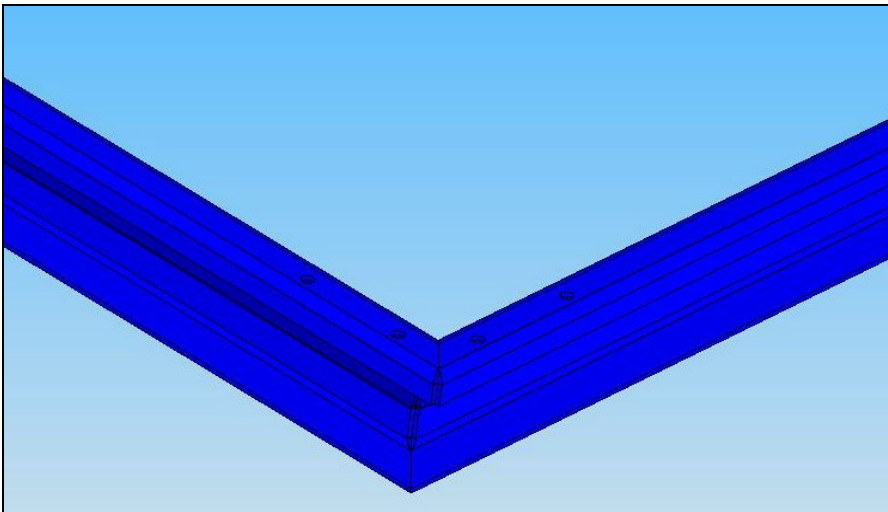

ORIGINAL INSTRUCTION
PART A: Basic machine
Shredder G Series

5.3 Machine (Standard execution)

Illustration:

- (1) Base frame
- (2) Lower housing flap
- (3) Infeed hopper
- (4) Gear box
- (5) Drive motor
- (6) V-belt protection
- (7) Pusher protection
- (8) Discharge area
- (9) Screen controls



The machine housing, the drive motor, the gear box, the hydraulic system and the terminal box, for the electrical connections, are mounted on the base frame.

ORIGINAL INSTRUCTION
PART A: Basic machine
Shredder G Series

5.4 Drive

The drive of the rotor ensues by means of an electric motor via "V"-belts. The motor, which is mounted on sliding rails or a motor plate, can be adjusted for regulating the tension of the "V"-belts by means of tensioning screws. The "V"-belt pulley is attached with a special tensioning element to the motor shaft.

Illustration:
Drive Motor

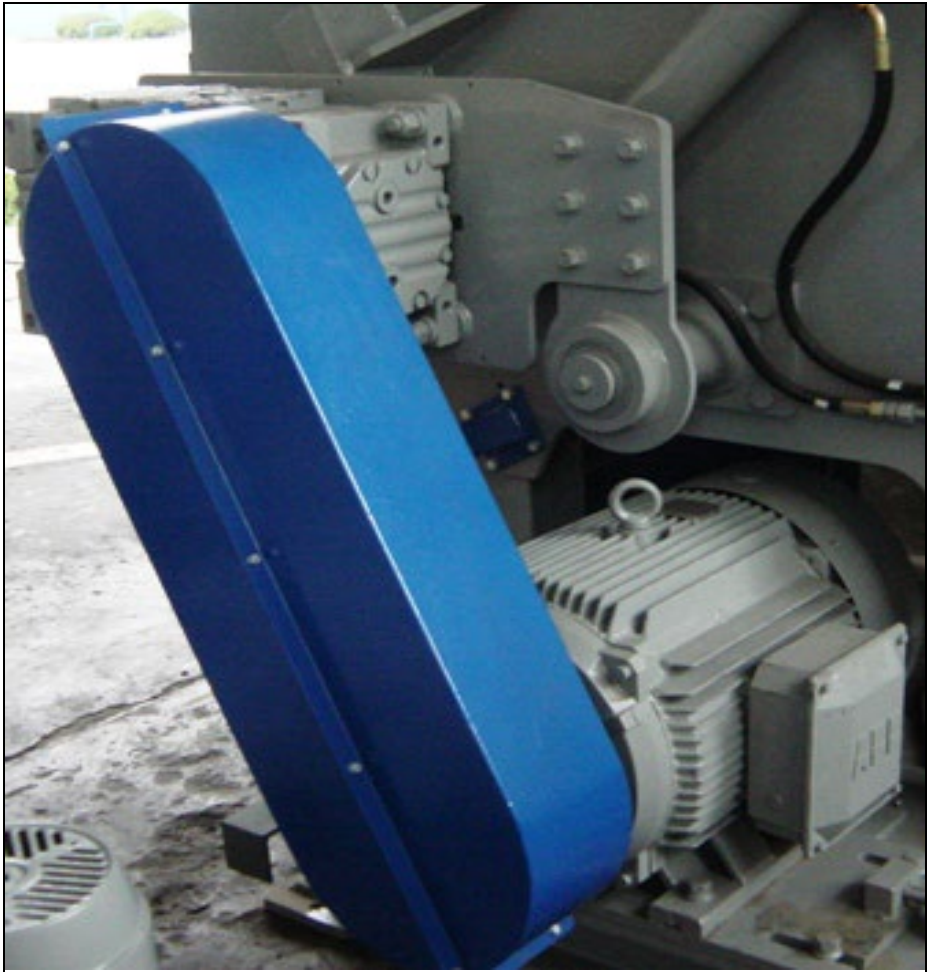

Please observe the operation manual from the manufacturer!

ORIGINAL INSTRUCTION
PART A: Basic machine
Shredder G Series

5.5 Rotor, knives and screen

5.5.1 Rotor and knives

The material is ground between the knives assembled on the rotor and the stator knives which are mounted in a fixed position in the machine lower section.

All rotors are equipped with square knives. These knives make light work of the heaviest pieces. The knives have four corners, so that they can be easily turned once a corner has worn out.

The design of the rotor has a significant influence on the quality of the grinding process and its results. The rotor construction, the type of knife mounting and the number of knives have all been exactly matched to your task allocation.

- Illustration:
- (1) Rotor knife
 - (2) Screen support(hydraulic)
 - (3) Stator knife

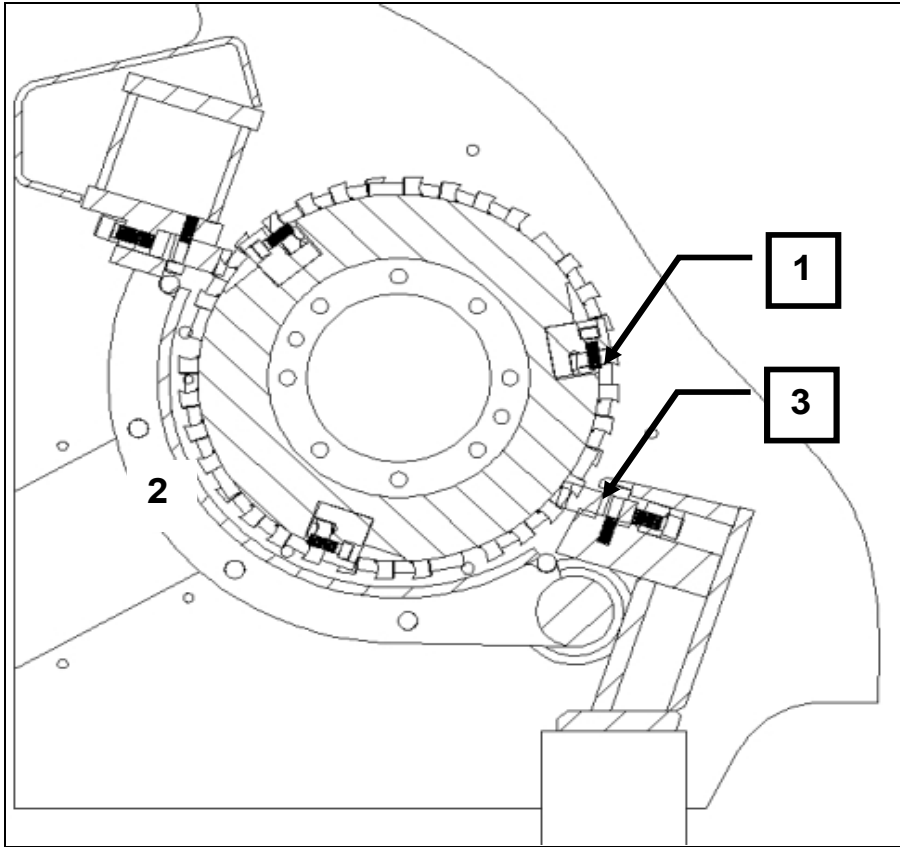

ORIGINAL INSTRUCTION
PART A: Basic machine
Shredder G Series

Illustration:
(1) Rotor knife
(2) Screen support

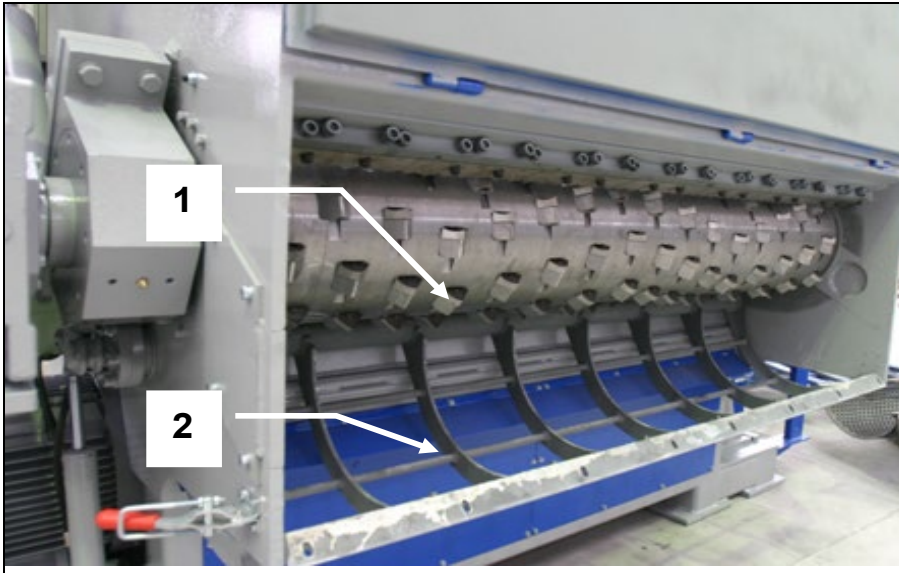

The rotor is accessible after opening the lower housing flap and removing the screen.

The rotor is arranged on roller bearings, which are situated outside the housing. The "V"-belt pulley is attached by means of a taper bush to the rotor axis. The rotor is dynamically counter balanced and has vibration-free concentricity.

Optional VIRTUS offers a water cooling system for the rotor for special applications.

Illustration:
Bearing with water plug
for rotor cooling



ORIGINAL INSTRUCTION

PART A: Basic machine

Shredder G Series

5.5.2 Screen and screen support

In the standard execution the screen and the screen support can be lowered by a hydraulic system.

The screen is slightly larger in its radius than the cutting circle of the rotor knives. The screen perforation is selected according to the desired grain size of the grinding material. All grinding material parts which are smaller than the screen perforation fall through the screen into the suction trough. The screen is replaceable and can be taken out after opening the lower housing flap.

Illustration:

- (1) Hydraulic cylinder
- (2) Screen support
- (3) Screen

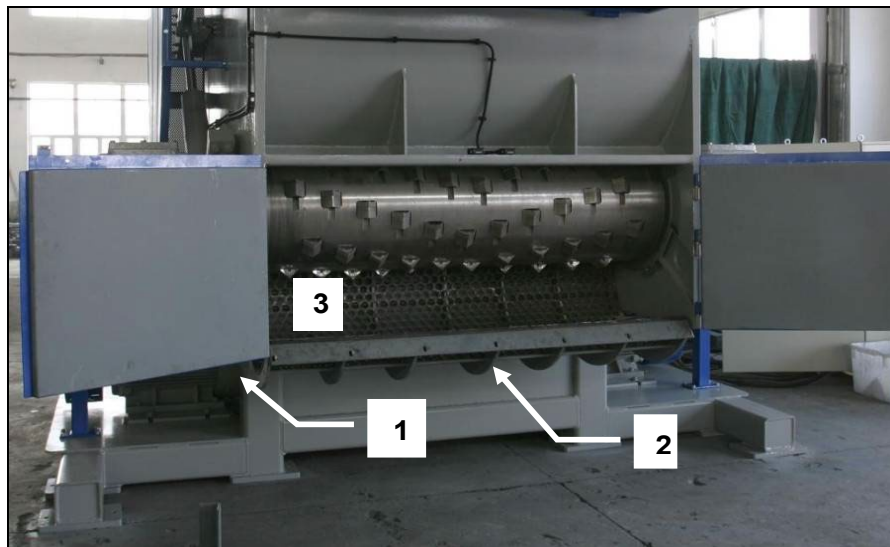

ORIGINAL INSTRUCTION
PART A: Basic machine
Shredder G Series

5.6 Discharge of grinding material

 WARNING	
	The machine is not allowed to run without suitable discharge device!

Illustration:
Conveyor belt discharge



Normally the ground material will be discharged by a conveyor belt.



CAUTION

The discharge conveyor has to be installed at the discharge area that possible access into this discharging zone to reach the rotor is blocked.
The distance between the discharge device and the shredder shall be not bigger than 80mm. The installation of conveyor in at the discharge area shall be according safety requirement category 3.

- Options:
- Discharge with a blower
 - Discharge with a screw conveyor

ORIGINAL INSTRUCTION
PART A: Basic machine
Shredder G Series

5.7 Hydraulic pusher

The hydraulic pusher is fixed on two arms, which are arranged on flange bearings. Two heavy duty hydraulic cylinders ensure that the ram moves forward and backwards. When the machine is operated in automatic mode the pusher moves automatically after switching on the hydraulic system and the shredder. If you run in manual mode the pusher can be moved by hand on the control panel.

Illustration: new pic

- (1) Hydraulic cylinder
- (2) Bearing
- (3) Arm
- (4) Pusher
- (5) Hydraulic Unit

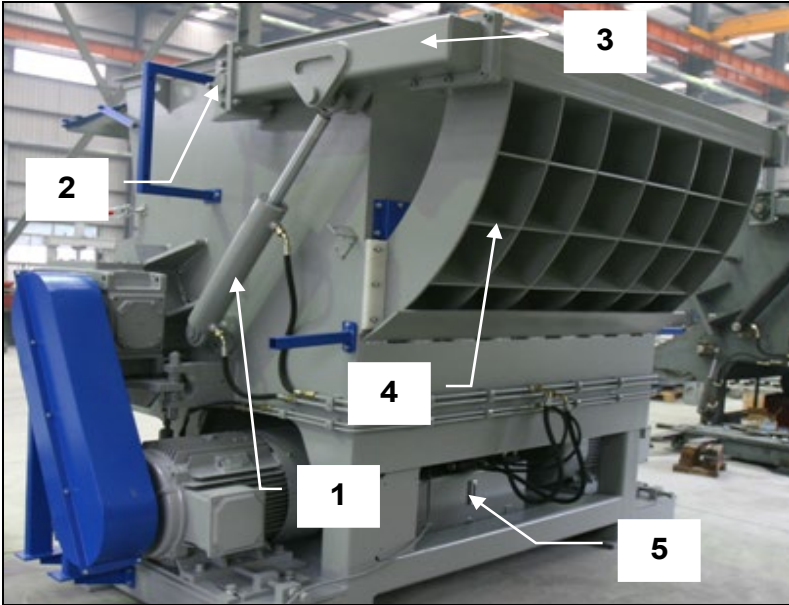
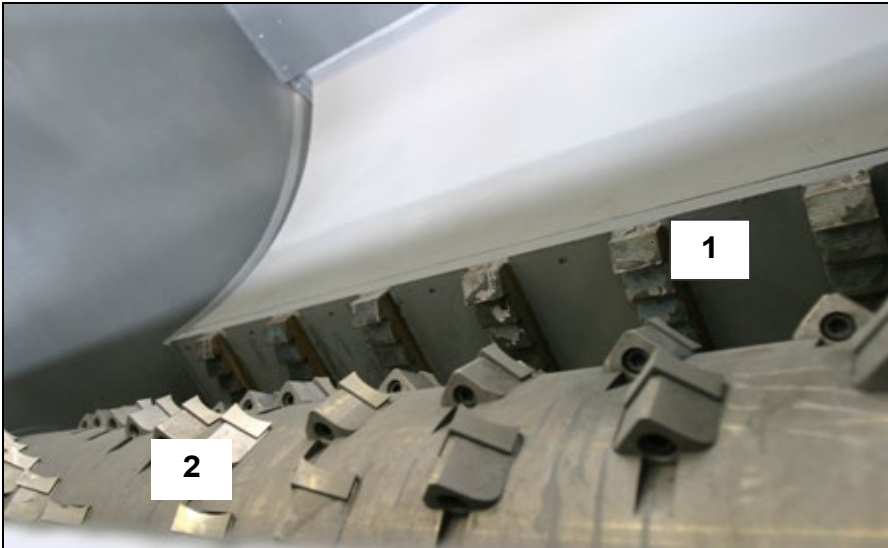

Illustration:

- (1) Pusher front plate
- (2) Rotor



ORIGINAL INSTRUCTION
PART A: Basic machine
Shredder G Series

5.8 Control panel

Illustration:
 Control panel

- (1) Main switch
- (2)
- (3)

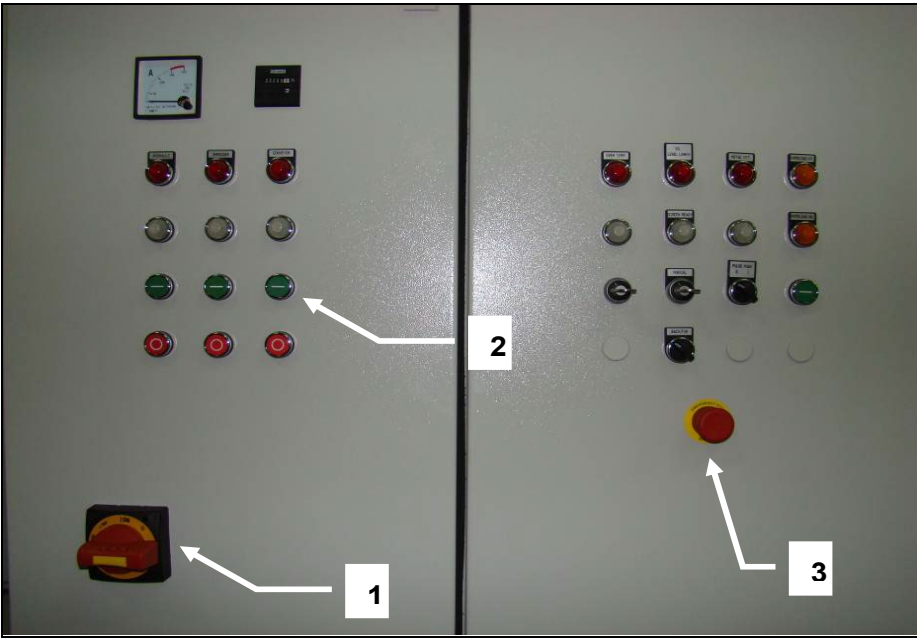
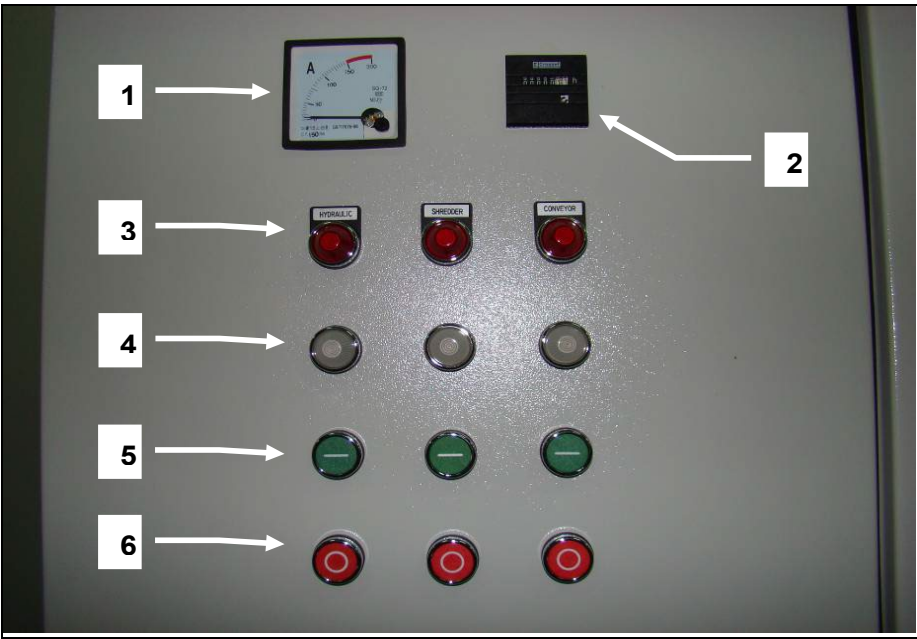

Illustration:
 2

- (1) Ampere meter
- (2) Elapsed hour counter
- (3) Error lights
- (4) Control lights
- (5) Start buttons
- (6) Stop buttons



ORIGINAL INSTRUCTION

PART A: Basic machine

Shredder G Series

Illustration:
3

- (1) Emergency STOP
- (2) Error lights
- (3) Control lights
- (4) Overload lights
- (5) Key switch for hydraulic screen
- (6) Key switch for manual mode
- (7) Pusher manual
- (8) Reset
- (9) Pulse/Push function

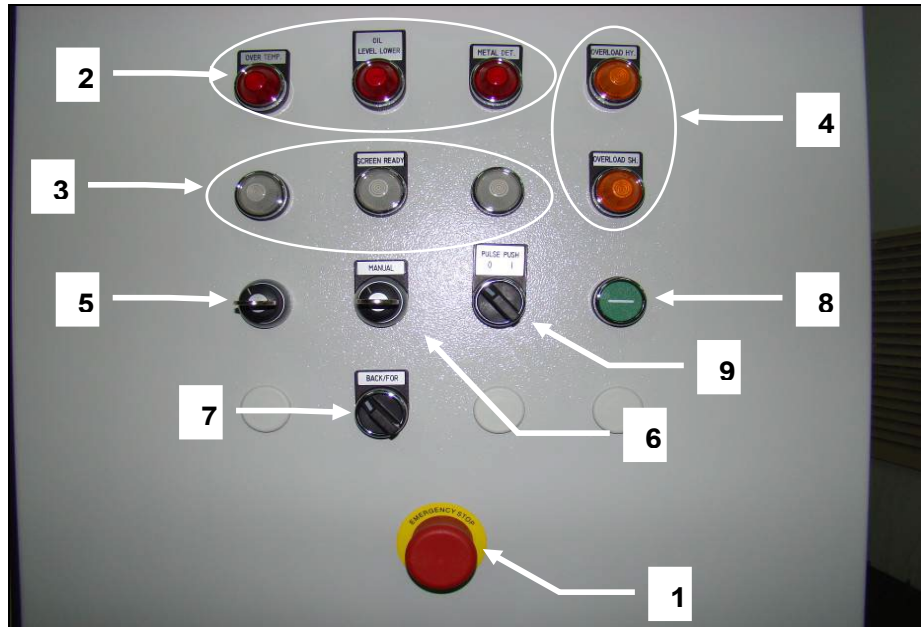
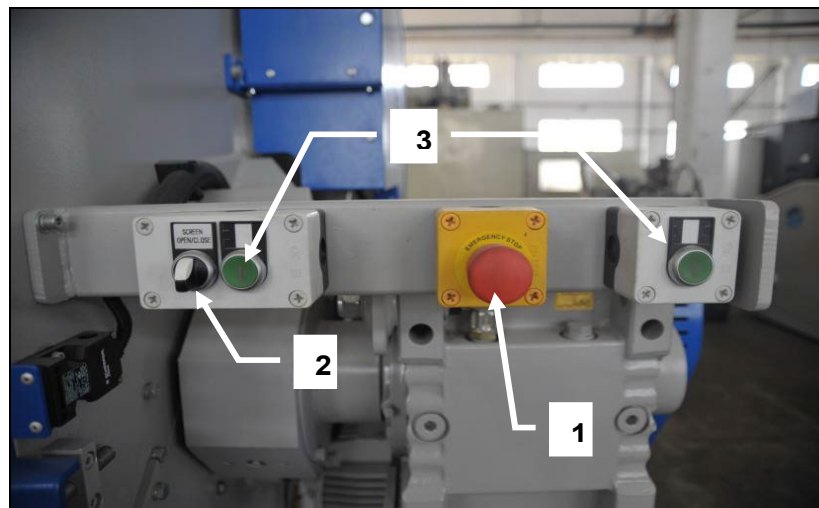

Illustration:
Control panel for hydraulic screen

- (1) Emergency STOP
- (2) Selection screen open/close
- (3) two-hand control switch operate



5.8.1 Pulse/Push function

In normal process mode the pusher pushes forward continuously till the pusher arm reaches the proximity switch which reverses the function and the pusher moves backwards.

By changing the switch (9) to “Pulse push” function on the main control board the pusher moves forward in steps. This means, after each step the pusher remains in his position for a small while before it moves forward again.



This function should be used for very heavy applications and in case of danger to overload the system



6 INITIAL STARTUP



6.1 General Advice

All work related to start-up may only be carried out by trained specialist personnel.

Check the machine for possible transportation damage or other damage. Should you determine damage, have this confirmed by the freight company and please report this to us in writing immediately after delivery. When starting up for the first time and after setting up ready for service, you must carry out the necessary checks according to the chapter *Machine Check prior to Initial Start-up*.

 WARNING	
	<p>Check the oil level of the gear box, before operating the machine. Please observe the operation manual from the manufacturer!</p>

 WARNING	
	<p>Fill oil into the hydraulic tank. Please observe the operation manual from the manufacturer!</p>

 WARNING	
	<p>The shredder shall be installed so that no items can be thrown out of the discharge area causing hazards!</p>

6.2 Requirements at the application site



The site of application for the machine must exhibit the following features:

- Enclosed space.
- The ground must exhibit sufficient load-bearing capacity (you can find the machine weight in the *Chapter Technical Data*). The unevenness of the ground surface may not exceed 5 mm.
- The machine must be freely accessible from all sides.
- There must be sufficient room available for operating and service personnel.
- Spatial requirements: see *Assembly drawing*. All hinged parts must be able to be opened completely.
- Vibration-free environment.
- The application site must be well-lit.
- The machine may not be exposed to direct radiation caused by radiators or the sun.
- Room temperature: +5° to +40°C
- Relative atmospheric humidity according to DIN 40040:
15 to 70 % (indoor)
By humidity levels higher than 70 %, apply anticorrosive agent to the metallic-finished machine parts. Insulation for the tropics is also necessary.
- The machine may not be operated within range of static discharges or strong magnetic fields as this could lead to faults in the machine control system.



ORIGINAL INSTRUCTION
PART A: Basic machine
Shredder G Series

6.3 Unloading and installing the machine

The machine or the machine components are packed so that they will arrive to you safely. To see how the machine is packed or should be packed, please see the *Packing plan*. For unloading the packaged machine or machine components you may use a suitable crane or forklift.

 WARNING	
	<p>Suspended load. Falling loads can cause serious injury or death. Only use a crane or a forklift which is suitable for the weight and the dimensions of the load.</p>
	<p>Also use a suitable stopping means and pay attention to the gravity centre location. Do not step under the suspended load. Wear a safety helmet in addition to your basic protective gear.</p>

- ↓ After unloading, remove the packaging material and all transportation safety devices.
- ↓ In the case that the shredder and its accessory components have been delivered as individual items, mount these at the site of ap
- ↓ in accordance with the data given in the *Assembly drawing*. Only in this way can it be guaranteed that there are sufficient delivered piping parts, tubing and cable connections and that the linking places match.



 WARNING	
	<p>Overturning or falling machine. Serious injury or death can result. In the case that you wish to erect the granulator over a pit, on a frame or on a platform, you must secure the machine by putting mounting screws through the holes on the mounting pads (see <i>Assembly drawing</i>). If assembling the machine on solid ground, this safety device is not absolutely necessary.</p>

- ↓ Align the machine horizontally with the help of a suitable spirit level.
Do not use blocks to place underneath the machine, use instead metal strips in order to prevent buckling of the base frame. Make sure that an even distribution of weight is achieved on all the points of support.

ORIGINAL INSTRUCTION
PART A: Basic machine
Shredder G Series



6.4 Electrical connection

Electrical connections should only be made by a qualified electrician.

 WARNING	
	<p>Dangerous voltage. Touching live parts can lead to serious injury or death. All work which relates to the electricity of the machine may only be carried out by trained electricians. Observe the currently effective EMC regulations.</p>

Voltage, current, frequency and protection are marked on the *Type plate*. The voltage tolerance is $\pm 10\%$.

- ↓ For machines which have not been pre-wired by VIRTUS, the electrical connection is to be carried out in accordance with the enclosed *Wiring diagram* in the terminal box.
When doing this, the regulations of the local electricity authority are to be adhered to. The cable cross section required is to be determined according to the rated capacity of the units.

 WARNING	
	<p>When operating specific equipment caution must be taken to prevent electrical shock. Installation, service, alterations and or modifications must only be done by qualified personal and with high regard for safety. Not conforming to the requirements could result in bodily injury, death or costly damage.</p>

HINT



Alterations to the wiring diagrams from VIRTUS require our approval. Failure to do this will exclude all guarantee claims.

The wiring schematics are located in the control panel in the event that the control panel is a part of the delivery.

ORIGINAL INSTRUCTION
PART A: Basic machine
Shredder G Series

Connection of Emergency Stop button

The machine may only be operated with installed Emergency Stop buttons. In the case that no Emergency Stop buttons have been installed at the factory, an Emergency Stop button must be installed at the control cabinet, the second at the grinding material in feed.



HINT

The control panel with the switches and Emergency Stop button should be installed nearby the machine. The distance should not exceed 5 m.

The distance between the floor and the lower edge of the control panel should be at least 1 m.

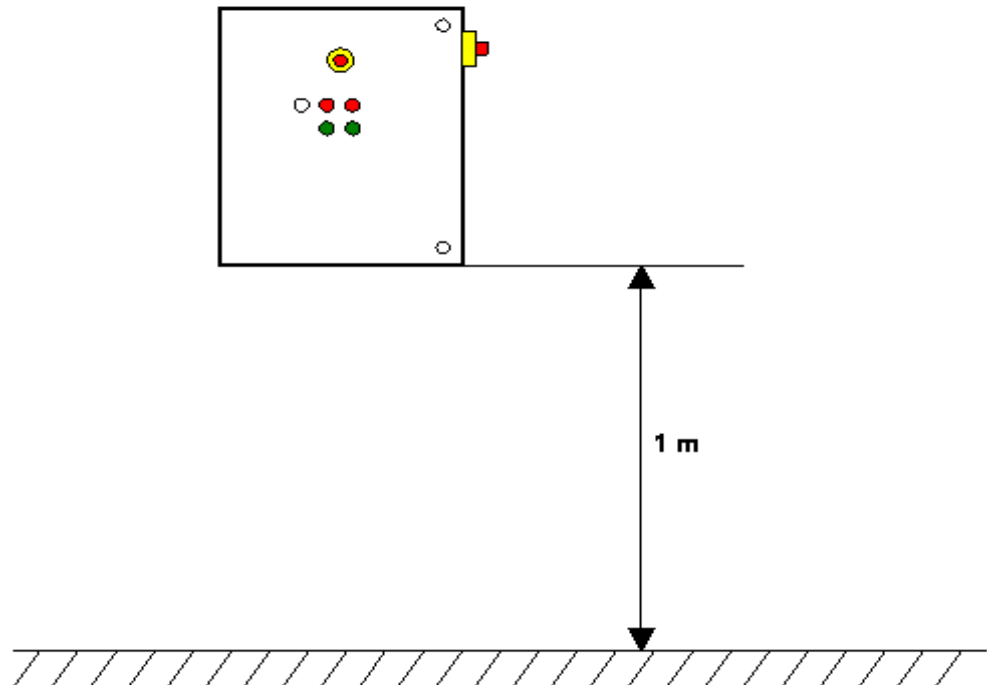

The connecting cables between control panel and machine have to be protected against damage (cable tray, protective sleeve).

If the control box cannot be installed according to this rules an additional Emergency Stop button has to be installed on the machine.

ORIGINAL INSTRUCTION
PART A: Basic machine
Shredder G Series

Checking the rotational direction

Rotational direction of the motors must be checked before initial start-up (see chapter of same name). The steps prior to this check must be completed.

- ↓ Switch the machine on and then immediately off again (see *Switch on machine* and *Switch off machine*).
- ↓ Observe whether the discharge air fan in the drive motor is rotating in the direction of the direction arrow.



HINT

If running in the wrong direction, reconnect the motor connection immediately. Damage to the machine will result from operation in the wrong direction.

ORIGINAL INSTRUCTION
PART A: Basic machine
Shredder G Series

6.5 Machine check prior to initial start-up

Check	See chapter
1. When lower housing flap is opened, check the knife mounting screws using a torque wrench.	<i>Replacing and checking the cutting knife mountings.</i>
2. Search the grinding chamber for foreign matter.	<i>Cleaning the machine</i>
3. Open the lower housing flap and check whether the screen has been inserted in accordance with the regulations.	<i>Emptying the screen</i>
4. Close upper housing flap and fasten screws tightly.	
5. Check oil level of the gear box	<i>Hydraulic Maintenance</i>
6. Fill in oil into the hydraulic unit	<i>Hydraulic Maintenance</i>
7. Examine in feed device (accessories) for foreign matter.	<i>Part B: Accessories.</i>
8. Check that the <i>Emergency Stop buttons</i> are unlocked.	
9. Check all safety devices for proper functioning.	<i>Checking the protective devices.</i>
10. Switch on machine for a short time and check rotational direction. The rotational direction can be seen at the discharge air fan of the drive motor (observe running direction arrow).	<i>Electrical connection.</i>
11. Switch on hydraulic unit for a short time and check rotational direction.	<i>Hydraulic pusher</i>
12. Allow machine to run for approx. 10 minutes without grinding material.	<i>Switch on machine.</i>
13. Connect material discharge device (accessories) and in feed device (accessories), check rotational direction drives.	<i>Part B: Accessories.</i>
14. Feed grinding material uniformly. Too much grinding material can lead to overload of the machine.	<i>Manual in feed of grinding material.</i>
15. If necessary, check the temperature of the ground material.	
16. Monitor the ammeter. This displays the present current consumption and in this way gives information on the load of the machine.	

7 OPERATION

**Have you read and understood the operation manual, in particular the safety advice in the Chapter Four?
You may not operate the machine until you have done so!**

TIP



Should faults occur during work with the machine, please observe the advice in the chapter *Troubleshooting*.

7.1 Machine checks before switching on the machine

Check	See
1. The knives are properly set and the screws are tightened with the specified torque.	<i>Replacing and checking the cutting knife mountings.</i>
2. The screen is inserted into the screen support in accordance with the rules and the screen support is fixed at the end position with tightened mounting screws.	<i>Emptying the screen</i>
3. The grinding chamber is free of foreign matter.	<i>Cleaning the machine.</i>
4. The housing flaps are closed.	
5. All safety devices, including those of the installed grinding material in feed and discharge devices, are checked and operative.	<i>Checking the protective devices.</i>

7.2 Switch on machine



1. Switch on the grinding material discharge device.
2. Switch on the Shredder (main switch to 1). Wait until the rotor has reached its full speed and switched from star to delta.
3. Switch on the hydraulic system.
4. Switch on the grinding material in feed device (accessories).

ORIGINAL INSTRUCTION
PART A: Basic machine
Shredder G Series

7.3 Switch off machine

- 1. Switch off the grinding material in feed device (accessories).
- 2. Wait until the remaining grinding material has been ground, and then switch off the shredder, (main switch to 0).
- 3. Switch off the grinding material discharge device.



7.4 Manual in feed of grinding material

 DANGER	
	<p>Rotating knives. Can cause serious cutting and crushing injuries, possibly leading to death. Do not reach into the in feed hopper or lean in whilst the rotor is running (pay attention to the run down time). Only use approved grinding material.</p>

↓ Throw the grinding material into the in feed hopper.

The machine should be feed from the front.

If in your design of machine an additional in feed device is installed, please observe the additional information for work with and on the in feed device *Part B: Accessories*.



 DANGER	
	<p>Do not climb into the in feed hopper while operating the machine. You will die.</p>

ORIGINAL INSTRUCTION
PART A: Basic machine
Shredder G Series

8 MAINTENANCE

8.1 Safety advice

Trained specialist personnel may only carry out work included within the framework of maintenance. Carry out the maintenance work within the specified time and document this. The machine will thank you for this by providing high reliability.

 WARNING	
	Danger caused by electrical voltage and starting the machine during maintenance work. Mortal danger.
	Therefore, as a basic rule when carrying out maintenance work: Main switch to 0, safeguard using padlock and attach a warning sign.

8.2 Maintenance plan

The tasks for maintenance work are described in detail in this chapter.

Maintenance work	Oh = Operation hours		
	Every Day	Every Week	Every Month
Check protective devices for proper functioning.	x		
Clean machine.			x
Check cutting knife mountings.	x		
Check the main bearings (bearing clearance, lubricant renewal).			x
Lubricant replacement, lubricant renewal	See <i>Lubrication intervals</i>:		
Check "V"-belt tension force and "V"-belt condition.		X	
Check condition of cutting knives.	x		
Check all screws of the machine for a tight fit.		X	
Check wearing parts.		X	
Check hydraulic oil level and consistence		X	
Change hydraulic oil and oil filter	After every 2000Oh		
Check gearbox oil level	Every 2000 Oh		

Yearly maintenance



The purpose of yearly maintenance of the machine is primarily to check the general condition of the machine and to arrange for the supply of any necessary replacement parts in good time. A service engineer from VIRTUS Machinery & Recycling technology can also carry this out on request.

8.3 Checking the protective devices



For this, see also the chapter *Protective devices*.

Check the safety devices for:

- Stipulated condition,
- Stipulated location,
- Safe mounting,
- Stipulated function.



 WARNING	
	<p>Danger due to non-functioning protective devices. Serious injury or death can result.</p> <ul style="list-style-type: none">• Eliminate all defects before you put the machine into operation!• If defects occur during operation, stop the machine immediately and eliminate the defects!• Do not change or remove any protective devices. Do not put any protective devices out of action by modifying them.

8.4 Cleaning the machine

 WARNING	
	<p>Danger of cutting caused by sharp cutting knives, even when the rotor is at a standstill. Serious injury, particularly to hands and fingers, can result. Wear protective gloves.</p>

Proceed as follows:

- ↓ Switch off the shredder at the main switch
- ↓ Safeguard main switch using a padlock.
- ↓ Open the housing flaps.
- ↓ Safeguard the housing flap.
- ↓ Remove the screen
- ↓ Empty the screen

 WARNING	
	<p>Inhalation of grinding dust which is dangerous to the health. This can result in injury to the respiratory tract. Never blow out the grinding material residue, use suction instead. Wear breathing protection if necessary.</p>

- ↓ Pre-clean the grinding chamber using a hand brush.
- ↓ Suck up the remaining grinding material residue using a suitable suction device.
- ↓ Remove clinging grinding material residue using a suitable wooden scraper.
- ↓ Put the screen back into its working position and fasten with the mounting screws
- ↓ Close the housing flaps
- ↓ Machine can be started again

8.5 Replacing the gear box

The gearbox is dimensioned so that a replacement is only necessary in exceptional cases. Dismounting and mounting of the gear box requires specialist knowledge and a careful working method. Therefore, please observe the instructions given in the installation manual of the gear box manufacturer or ask the VIRTUS service department for help.

8.6 Replacing the rotor

The rotor is a heavy duty design so that a replacement is only necessary after a crash, e.g. a hammer fall inside. Dismounting and mounting of the rotor requires specialist knowledge and a careful working method.

8.6.1 Dismounting the rotor

To dismount the rotor proceed as follows:

The parts which are marked with a part number are illustrated in the drawings of the spare parts list!

- ↓ Dismount the "V"-belt cover.
- ↓ Dismount the "V"-belts (see *Work on the "V"-belts*).
- ↓ Dismount the gearbox (see *Replace the gearbox*)
- ↓ Remove the screen
- ↓ Remove the rotor mounting slot cover plates from the housing.
- ↓ Screw in hooks on both shaft ends.
- ↓ Hang on rotor on both shaft ends.
- ↓ Remove the bearing housing fixing bolt.
- ↓ Carefully lift out the complete rotor using suitable lifting and stopping means.
- ↓ Lay the rotor down in a safe location. Suitable for this are timber beams of appropriate size.

ORIGINAL INSTRUCTION
PART A: Basic machine
Shredder G Series

8.6.2 Mounting the rotor

To mount the rotor proceed as follows:

- ↓ Before mounting, clean the bearing seat surfaces and check the key.



HINT

- If the spare rotor is delivered without bearings, the bearings have to be mounted first(see Mounting the main bearings)
- ↓ Lift the rotor using suitable lifting and stopping equipment and put carefully into the bearing seats.
 - ↓ Attach the bearing housing (Pos.) to the bearing seats using screws.
 - ↓ Put the gear onto the rotor axis
 - ↓ Put back the rotor mounting slot cover plates
 - ↓ Put in the screen
 - ↓ Pull on "V"-belts and adjust the "V"-belt tension force (see *Retensioning and relaxing the "V"-belt*).
 - ↓ Attach the "V"-belt cover.
 - ↓ Carry out a test run.

8.7 Replacing the main bearings

The main bearings of the machine are dimensioned so that a bearing replacement is only necessary in exceptional cases. Dismounting and mounting of the bearings requires specialist knowledge and a careful working method. Therefore, in addition to the following advice, please observe the instructions given in the installation manual of the bearing manufacturer or ask the VIRTUS service department for help.

The bearings mounted in this machine are indicated in the spare parts list. A requirement for dismounting and mounting the bearings is a suitable pulling-off device.

8.7.1 Dismounting the main bearings

To dismount the bearings proceed as follows:

- ↓ Dismount the "V"-belt cover.
- ↓ Dismount the "V"-belts (see *Work on the "V"-belts*).
- ↓ Dismount the gearbox (see *Replace the gearbox*)
- ↓ Pull the distance sleeve off the rotor axis.
- ↓ Remove the screen
- ↓ Remove the rotor cover plates from the housing.
- ↓ Screw in hooks on both shaft ends.
- ↓ Hang on rotor on both shaft ends.
- ↓ Remove the bearing housing fixing bolt.
- ↓ Carefully lift out the complete rotor using suitable lifting and stopping means.
- ↓ Lay the rotor down in a safe location. Suitable for this are timber beams of appropriate size.
- ↓ Loose the bearings cover mounting screws and take off the bearing cover.
- ↓ Pull the bearing housing off with a pulling-off device.
- ↓ Pull the bearing off the rotor axis using a pulling-off device.

ORIGINAL INSTRUCTION
PART A: Basic machine
Shredder G Series

8.7.2 Mounting the main bearing

To mount the bearings proceed as follows:

- ↓ Before mounting, clean the bearing surfaces and the shaft surfaces thoroughly and grease lightly.
- ↓ Mount bearing in bearing housing.
- ↓ Attach the bearing with the bearing housing to the rotor axis.

HINT



- During mounting, the mounting forces must always engage into the inner ring, otherwise the roller bodies will be damaged.
 - The hardened bearing rings are sensitive to impact stress. For this reason, never hit directly on the rings with the hammer, use instead preferably a brass arbor or better still a striking bushing (piping piece) made from a soft material. The inner diameter of the striking bushing should be only slightly larger than the diameter of the bearing base.
 - The bearing is then pushed onto the shaft using light blows. When doing this, the force of pressure must be evenly distributed on the circumference of the bearing ring.
- ↓ Lift the rotor using suitable lifting and stopping equipment and place carefully into the bearing seats
 - ↓ Attach the bearing housing to the bearing seats using screws.
 - ↓ Push the distance sleeve onto the rotor axis.
 - ↓ Put the gear onto the rotor axis
 - ↓ Put back the rotor cover plates
 - ↓ Put in the screen
 - ↓ Pull on "V"-belts and adjust the "V"-belt tension force (see *Retensioning and relaxing the "V"-belt*).
 - ↓ Attach the "V"-belt cover.
 - ↓ Carry out a test run.

ORIGINAL INSTRUCTION
PART A: Basic machine
Shredder G Series

8.8 Lubricating the main bearings

An important requirement for high operational safety and long service life of the arrangement of bearings is the correct lubricant supply. Every VIRTUS machine is greased and checked in test runs before delivery.

HINT



Unsuitable lubricant, lubricant deficiency, excessive lubrication or impurities in the lubricant lead to overheating and thus extreme wear of the bearings.

8.8.1 Lubrication intervals:

Shift operation	Replace lubricant	Check
One shift operation:	every 18 months	monthly
Two shift operation:	every 9 months	monthly
Three shift operation:	every 6 months	monthly

8.8.2 Check lubricant quality

You can judge whether the lubricant needs to be replaced by checking for the following features:

- change in consistency,
- discolouration,
- degree of soiling.

8.8.3 Replacing or refilling lubricant

HINT



- **Fill the bearings uniformly with grease, so that all operating surfaces are well greased.**
- **For the rotor bearings, a lubricant quantity of one third to a maximum of half of the bearing volume per bearing is required. If too much grease is filled in, the lubricant will become unusable as a result of excessive temperature.**
- **Only one type of grease may be used, mixing different types of grease is not allowed. The bearings have been filled at the factory with lithium base saponification roller bearing grease F3.**
- **To find out which lubricants from which manufacturers you can use, look in the *List of lubricants*.**

ORIGINAL INSTRUCTION

PART A: Basic machine

Shredder G Series

Refilling lubricant

The grease reaches through the circulating grooves and bores via lubrication nipples into the interior of the bearing.
The greasing quantity is 60 to 100 g roller bearing grease F3 per bearing.

Illustration:
Grease nipple

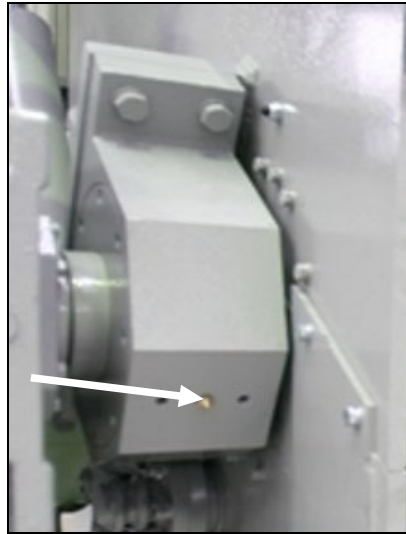

Replacing lubricant

Only in the case of unusual bearing noises or overheating is it also necessary to renew the lubricant between the specified intervals. Mounting and dismounting of the bearings is to be carried out in accordance with the instructions in this operation manual (see replacing the bearings).

- ↓ Open the bearing.
- ↓ Remove the bearing housing and the bearing cover.
- ↓ Clean the bearing carefully using petroleum ether.
Petroleum ether, petroleum, spirit, aqueous neutral or alkaline cleaning agents may be used to clean the bearings. After washing out, the bearing must immediately be preserved using lubricant, in order to avoid corrosion.
- ↓ Fill bearing with approved lubricant (see *List of lubricants*).

ORIGINAL INSTRUCTION
PART A: Basic machine
Shredder G Series

8.8.4 List of lubricants

Country of manufacture / manufacturer	Roller bearing grease
ARAL	ARAL Grease HL 3
BP	BP ENERGREASE LS 3
CASTROL	CASTROL SPHEEROL AP 3
ESSO	Beacon 3
FUCHS	FUCHS Grease 1200 FUCHS Grease FWA 220
SHELL	SHELL Alvania Grease 3
MOBIL-OIL	MOBILUX 3
WISURA	WISURA Liba L 3
Zeller & Gmelin	ZET GE Grease M 50
FAG	FAG L 71
ANTAR Petroles de l'Atlantique	ROLEXA
Holland, Beverol	Beverol Multi Purpose Grease
Italy, Agip	AGIP Grease 33 FD
Swede, NYNÄS	Nynäs FI 3-42

ORIGINAL INSTRUCTION
PART A: Basic machine
Shredder G Series

8.9 Mounting and dismounting TAPER-LOCK tensioning element

The motor- and the gear-"V"-belt pulleys are attached onto the shaft by means of a TAPER-LOCK tensioning element. The disks must be dismantled for certain maintenance work.

IMPORTANT: Follow all instructions in this manual carefully. This is necessary to insure satisfactory performance.

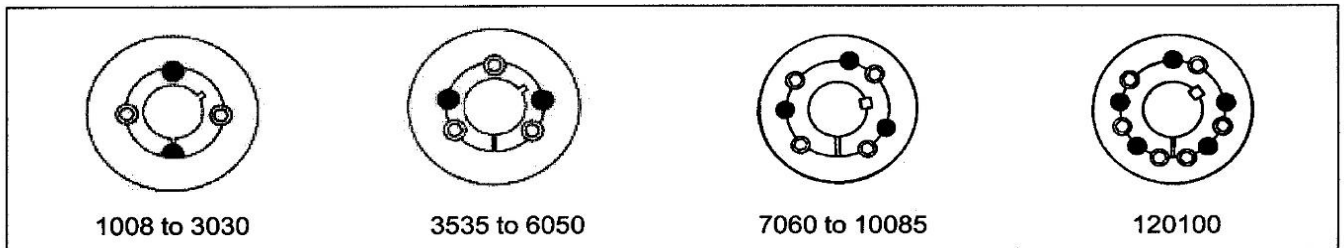

To Install:

1. Clean shaft, bore, and outside of bushing, and bore of hub (taking bushing from hub if already assembled). Remove any oil, lacquer, or dirt. Place bushing in hub and match half holes to make complete holes (each complete hole will be threaded on one side only).
2. Oil thread and point of set screws or thread and under head of cap screws. Place screws loosely in holes that are threaded on hub side (shown thus  in diagram).
3. Make sure bushing is free in hub. Slip assembly onto shaft and locate in position desired.
4. Tighten screws (see note*) alternately and evenly until all are pulled up very tightly. Use a piece of pipe on wrench to increase leverage. (See table for wrench torque on reverse side.)
5. Hammer against large end of bushing using hammer and block or sleeve to avoid damage. Screws can now be turned a little more using the specified wrench torque. Repeat this alternate hammering and screw re-tightening until the specified wrench torque no longer turns the screws after hammering.
6. After drive has been running under load for a short time stop and check tightness of screws. Fill other holes with grease to exclude dirt.

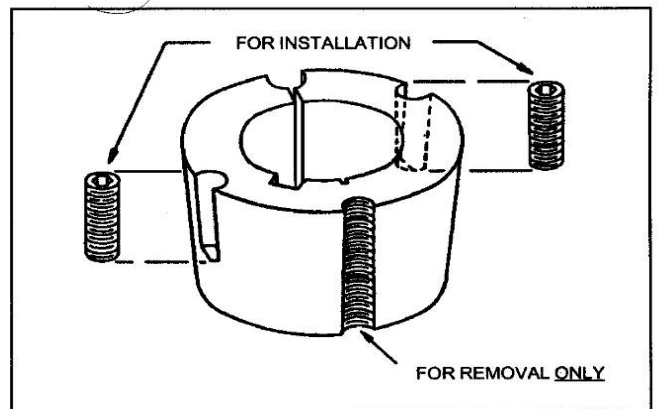

To Remove:

1. Remove all screws. Oil thread and point of set screws or thread and under head of cap screws.
2. Insert screws in holds that are threaded on bushing side (shown thus  in diagram). In sizes where washers are found under screw heads, be sure to use these washers. Note that one screw in each hub is left over and is not used in this loosening operation.
3. Tighten screws alternately until bushing is loosened in hub. If bushing does not loosen immediately, tap on hub.

8.9.1 Table for the tightening torque of the screws

Tensioning element (Type)	Screws- Tightening torque in Nm	Screw details	
		Number	Size (BSW)
3020	90	2	5/8"

ORIGINAL INSTRUCTION

PART A: Basic machine

Shredder G Series

8.9.2 Mounting the TAPER-LOCK tensioning element

Proceed as follows:

- ↓ Remove the protective coating from the bore and outside of bushing, and bore of hub. After ensuring that the mating tapered surfaces are completely clean and free from oil or dirt. Insert bushing in hub so that holes line up.
 - ↓ Sparingly oil thread and point of grub screws, or thread and under head on cap screws. Place screws loosely in holes threaded in hub, shown thus ☉ in.
 - ↓ Clean shaft and fit hub to shaft as one unit and locate in position desired, remembering that bushing will hip the shaft first and then will be slightly drawn on the bush.
 - ↓ Using a hexagon wrench tighten screws gradually and alternately to certain torque.
 - ↓ Hammer against large-end of bushing, using a block or sleeve to prevent damage. (This will ensure that the bushing is seated squarely in the bore). Screws will now turn a little more. Repeat this alternate hammering and screw tightening once or twice to achieve maximum grip on the shaft.
-
- ↓ If a key is to be fitted, place it in the shaft keyway before fitting the bushing. It is essential that it is a parallel key and side fitting only and has TOP CLEARANCE.
 - ↓ After drive has been running under load for a short time stop and check tightness of screws.
 - ↓ Fill empty holes with grease to exclude dirt.

8.9.3 Dismounting the TAPER-LOCK tensioning element

Proceed as follows:

- ↓ Slacken all screws by several turns, remove one or two according to number of jacking off holes shown thus • in the illustration. Insert screws in jacking off holes after oiling thread and point of grub screws or thread and under head of cap screws.
- ↓ Tighten screws alternately until bushing is loosened in hub and assembly is free on the shaft.
- ↓ Remove assembly from shaft.

ORIGINAL INSTRUCTION

PART A: Basic machine

Shredder G Series

8.10 Changing the screen

In order to keep the throughput of the shredder and the quality of the grinding material constant, the condition of the screen must be checked regularly.

The screen may be damaged, dirty or not suitable for the grinding material:

- Screen holes too fine: overheating of the grinding material.
- Screen holes too course: parts in ground material which are too big.

Proceed as follows:

- ↓ Switch off the shredder.
- ↓ Switch on the screen by using the key switch and wait until the light “screen ready” goes on.
- ↓ Safeguard main switch using a padlock.
- ↓ Open the lower housing flap.
- ↓ Safeguard the housing flap.
- ↓ Put the selection switch to “open” on the Screen controls
- ↓ Pivot the screen support downwards, by pushing two-hand control switches.

Illustration:

- (1) Hydraulic cylinder
- (2) Screen support
- (3) Screen

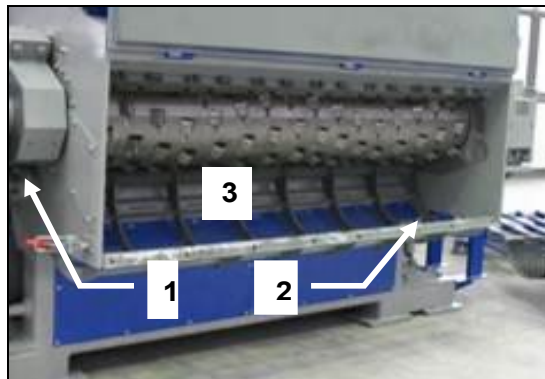

ORIGINAL INSTRUCTION

PART A: Basic machine

Shredder G Series

Illustration:
Control panel for
hydraulic screen

- (4) Emergency STOP
- (5) Selection screen
open/close
- (6) two-hand control
switches operate

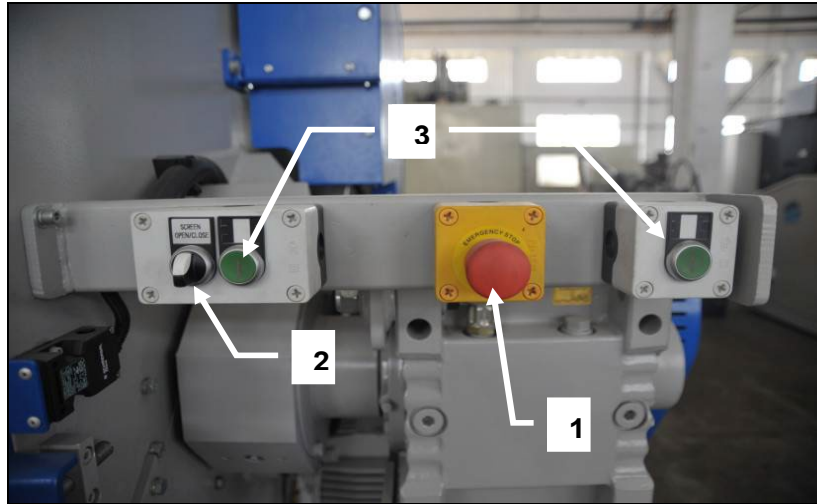

- ↓ Remove the screen.
- ↓ Empty the screen.
- ↓ Put the screen back into the screen support.
- ↓ Put the selection switch to “close” on the Screen controls
- ↓ Pivot the screen support upwards, by pushing two-hand control switches.
- ↓ Close the housing flap.
- ↓ Switch off the screen by using the key switch.
- ↓ Shredder can be started again

ORIGINAL INSTRUCTION
PART A: Basic machine
Shredder G Series

8.11 Work on the "V"-belts

"V"-belts are wearing parts, which stretch and must be retensioned. In order to guarantee a long service life of the "V"-belts, regular checks on the tension force of the "V"-belts and the condition of the "V"-belts are necessary.

CAUTION



All screws at the V-belt cover are safety screws which are mounted to the upper part! When disabling the cover, all screws must be losing at the same time. Otherwise damage could result!

8.11.1 Checking the tension force of the "V"-belt

Illustration:

- a: Distance between roller centres
- b: Sag
- F: Force(direction)

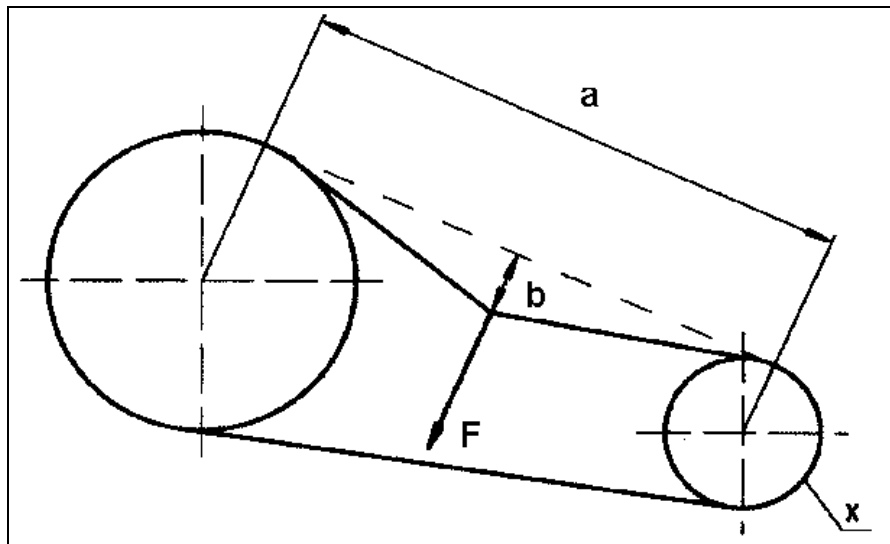

- ↓ Remove the "V"-belt cover.
- ↓ Measure the distance between the roller centres.
- ↓ Determine the belt sag force F for each belt at 16 mm sag if sag "b" is equal to 1 m distance between roller centres. Do this by measuring at the middle of the distance between roller centres at a right angle to the "V"-belt.

		Force required for 1 m distance between roller centres and 16 mm sag	
Profile section	Efficiency of x in mm	P in Newton	P in lbs
SPB	160 - 224	35 - 50	7,7 - 11
SPB	236 - 315	50 -65	11 - 14,3

ORIGINAL INSTRUCTION

PART A: Basic machine

Shredder G Series

- ↓ Compare determined value with the value in the above table. If the value lies below the lowest tolerance limit, the "V"-belt must be retensioned. If the value lies above the highest tolerance limit, the "V"-belt must be relaxed.



8.11.2 Retensioning and relaxing the "V"-belt

Enlarging or decreasing the centre distance "A" into which the drive motor is shifted carries out tensioning or relaxing the "V" - belt.

Proceed as follows:

- ↓ Loosen the tensioning screw.
- ↓ Shift the drive motor as required onto the sliding rails.
- ↓ Lock the drive motor into new position using both tensioning screws in such a way that the motor shaft is parallel to the rotor axis and aligned.
- ↓ Check the tension force of the "V"-belt (see *Checking the tension force of the "V"-belt*).
- ↓ Mount the "V"-belt cover.

8.11.3 Checking "V"-belt condition, replacing "V"-belt

 CAUTION	
	<p>Danger of pulling into machine caused by running "V"-belts. Hair, jewellery etc. can be pulled into the machine. Serious injury can result. Never dismount the "V"-belt cover and window during operation.</p>

- If a "V"-belt is porous or ripped, it must be replaced as follows:
- ↓ Remove the "V"-belt cover.
 - ↓ Loosen the front and rear tensioning screw.
 - ↓ Relax the "V"-belt by shifting the drive motor.
 - ↓ Put new "V"-belt in.
 - ↓ Tension the "V"-belt (see *Retensioning and relaxing the "V"-belt*).
 - ↓ Mount the "V"-belt cover.

ORIGINAL INSTRUCTION

PART A: Basic machine

Shredder G Series

8.12 Working on the cutting knives

In the case of shredders, the correct grinding properties, correct setting and mounting of the cutting knives are important factors to ensure perfect functioning and economic operation of the machine.

8.12.1 Replacing and checking the cutting knife mountings

Due to their function, certain machine parts are subject to stress in their operating state as a result of vibrations, which can lead to loosening of the screw connections. Therefore, it is absolutely necessary to check the cutting knife mounting screws in accordance with the *Maintenance plan*.

- ↓ Tighten the mounting screws on the cutting knives using a torque wrench which is set to the required torque for the screw size.
The required torque for the knife fixing bolts is 120 Nm.



You can find out the required torque from the following table. Take note too that the tightening capacity decreases of screws which have been loosened and tightened again several times. New screws of the same material quality must therefore replace the cutting knife mounting screws after they have been loosened and tightened several times.

Torque:

Bolt type	Grade 8.8		Grade 10.9		Grade 12.9	
	Nm	lbf ft	Nm	lbf ft	Nm	lbf ft
M8	25	18.4	35	25.8	41	30.2
M10	49	36.1	69	50.9	83	61.2
M12	86	63.4	120	88.5	145	106
M16	210	154	295	217	355	261
M20	410	302	580	428	690	508
M24	710	523	1000	737	1200	885

ORIGINAL INSTRUCTION
PART A: Basic machine
Shredder G Series

8.12.2 **Checking the condition of the cutting knives**

 WARNING	
	<p>Danger of cutting caused by sharp knives, even when the rotor is at a standstill. Serious injury, particularly to hands and fingers, can result. Wear protective gloves.</p>

The cutting knives become blunt after a certain number of operation hours. Therefore they should be checked regularly.

Using blunt knives has the following consequences:

- Decreased grinding capacity.
- Increased current consumption of the drive motor.
- Inexact cut.
- Overheating of the ground material.

ORIGINAL INSTRUCTION
PART A: Basic machine
Shredder G Series

8.12.3 Dismounting the rotor knives

! WARNING



Danger of cutting caused by sharp knives, even when the rotor is at a standstill. Serious injury, particularly to hands and fingers, can result. Wear protective gloves.

Proceed as follows:

Illustration:

- (1) Rotor knife
- (2) Knife mounting screw
- (3) Knife holder
- (4) Knife holder mounting screws

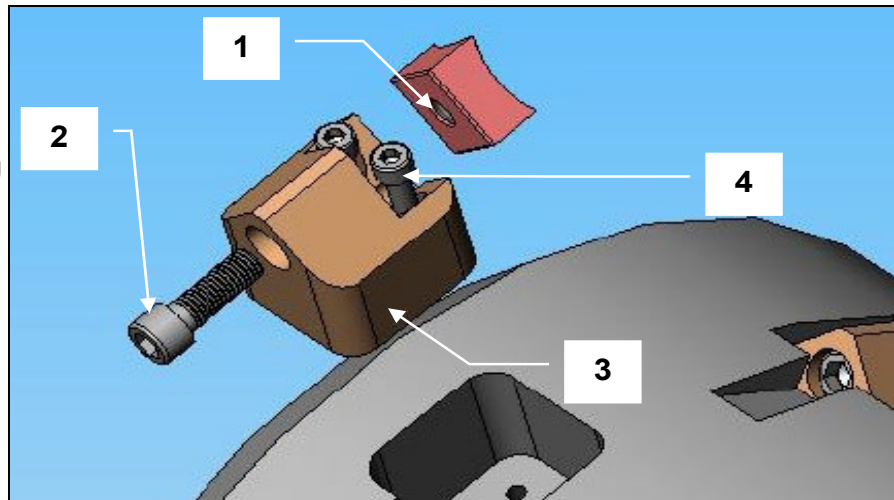

- ↓ Switch off the shredder at the main switch
- ↓ Safeguard main switch using a padlock.
- ↓ Open the lower housing flap.
- ↓ Safeguard the housing flap.
- ↓ Remove screen

Although it is possible to reach the cutting shaft by climbing into the feeding chamber, we recommend accessing the knives through the front side door. The shaft can be rotated manually by turning the motor v-belt pulley.

-
- ↓ Clean the hexagon head socket of the knife fixing bolt (2).
- ↓ Loose the bolt using a high quality Allen key (10 mm). If necessary knock the Allen key lightly with a hammer to loose it.
- ↓ Take out the knife fixing bolt, the washer and the knife

ORIGINAL INSTRUCTION
PART A: Basic machine
Shredder G Series

8.12.4 Dismounting the rotor knife holders

! WARNING



Danger of cutting caused by sharp knives, even when the rotor is at a standstill. Serious injury, particularly to hands and fingers, can result. Wear protective gloves.

Proceed as follows:

Illustration:

- (1) Rotor knife
- (2) Knife mounting screw
- (3) Knife holder
- (4) Knife holder mounting screws

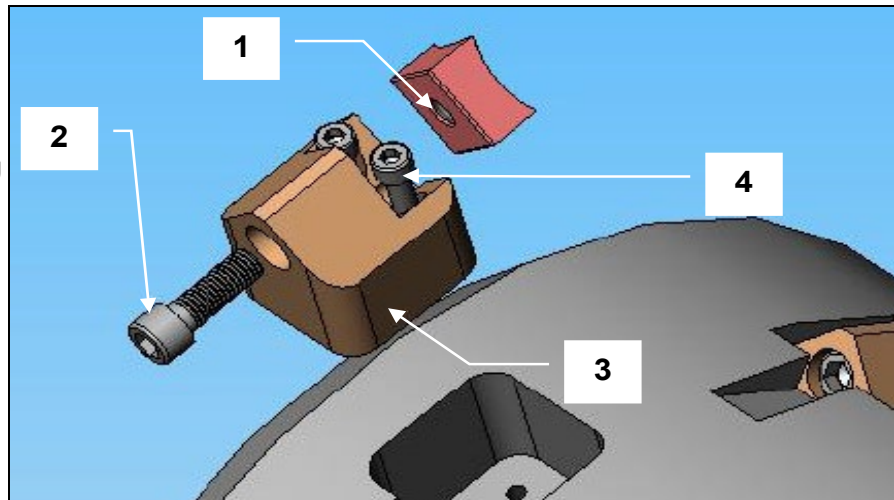

- ↓ Switch off the shredder at the main switch
- ↓ Safeguard main switch using a padlock.
- ↓ Open the lower housing flap.
- ↓ Safeguard the housing flap.
- ↓ Remove screen

Although it is possible to reach the cutting shaft by climbing into the feeding chamber, we recommend accessing the knives through the front side door. The shaft can be rotated manually by turning the motor v-belt pulley.

-
- ↓ Clean the hexagon head socket of the knife fixing bolt (2).
- ↓ Loose the bolt using a high quality Allen key (10 mm). If necessary knock the Allen key lightly with a hammer to loose it.
- ↓ Take out the knife fixing bolt, the washer and the knife
- ↓ Clean the hexagon head socket of the knife holder fixing bolts (4).
- ↓ Loose the bolt using a high quality Allen key (6 mm). If necessary knock the Allen key lightly with a hammer to loose it.
- ↓ Take out the knife holder fixing bolts.
- ↓ Remove the knife holder with the delivered Extractor.

ORIGINAL INSTRUCTION
PART A: Basic machine
Shredder G Series

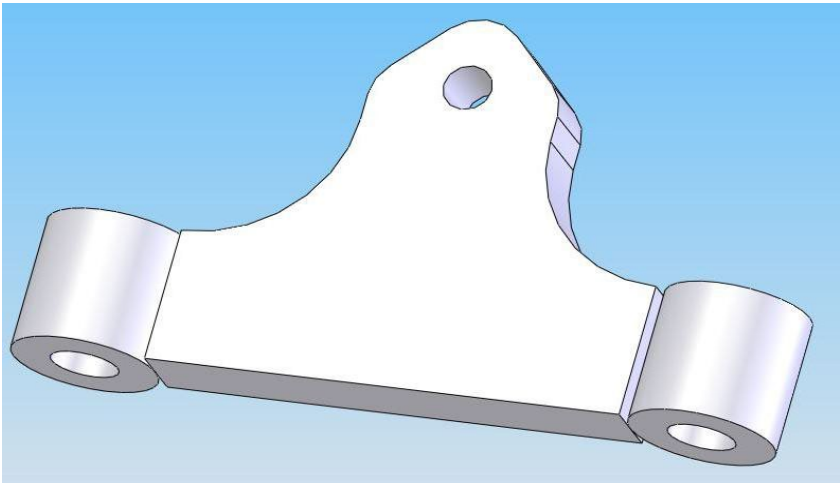

ORIGINAL INSTRUCTION

PART A: Basic machine

Shredder G Series

8.12.5 Dismounting the stator knives

WARNING



**Danger of cutting caused by sharp knives, even when the rotor is at a standstill.
Serious injury, particularly to hands and fingers, can result.
Wear protective gloves.**

Proceed as follows:

Illustration:

- (1) Stator knife
- (2) Knife fixing screws
- (3) Knife holder
- (4) Cover plates
- (5) Knife adjusting screw for pushing
- (6) Knife adjusting screw for pulling
- (7) Cover plate fixing screws

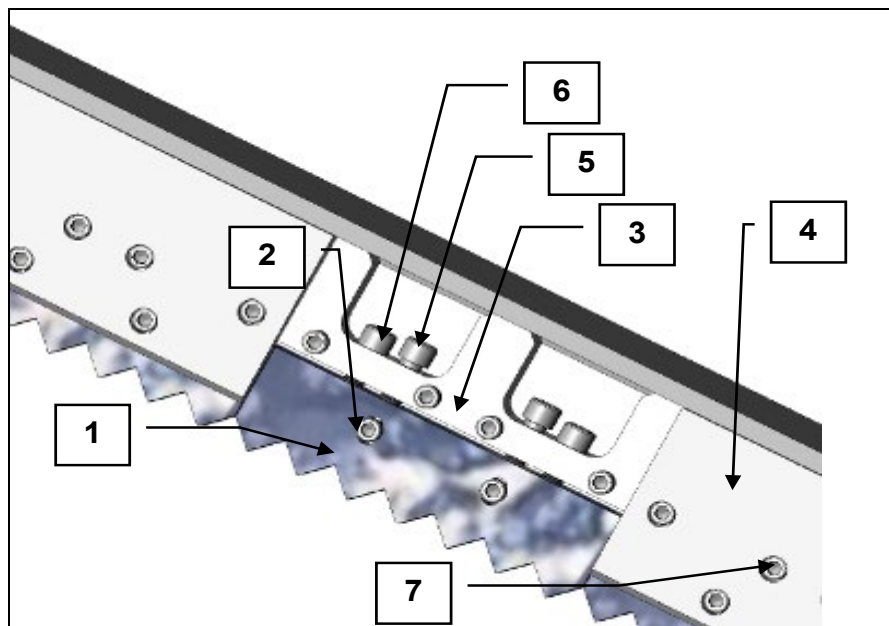



- ↓ Switch off the shredder at the main switch
- ↓ Safeguard main switch using a padlock.
- ↓ Open the upper housing flap.
- ↓ Safeguard the housing flap.

Although it is possible to reach the knives by climbing into the feeding chamber, we recommend accessing the knives through the front side door.

- ↓ Clean the hexagon head socket of the knife fixing bolts (2) and the cover plates fixing bolts.
- ↓ Loose the cover plate fixing bolts using a high quality Allen key (10 mm). If necessary knock the Allen key lightly with a hammer to loose it.
- ↓ Take out the bolts and the cover plates
- ↓ Loose the knife adjusting screws for pulling and take them out
Loose the knife fixing bolts using a high quality Allen key (10 mm).
If necessary knock the Allen key lightly with a hammer to loose it.
- ↓ Take out the knife fixing bolt, and the knife

ORIGINAL INSTRUCTION
PART A: Basic machine
Shredder G Series

8.12.6 Mounting the rotor knife holders

 WARNING	
	<p>Danger of cutting caused by sharp knives, even when the rotor is at a standstill. Serious injury, particularly to hands and fingers, can result. Wear protective gloves.</p>

Proceed as follows:

- ↓ Clean the knife pocket and the knife holder
- ↓ Insert knife holder into the pocket

Knife holder must slide in easily. Do not damage the knife holder surfaces using a hammer.

- ↓ Put in the knife holder fixing bolts (DIN912 – M8x25 – 12.9) and put some Loctite on them.
- ↓ **Make sure that the knife holder fits properly.**
- ↓ Tighten the knife fixing bolts using a torque wrench.

The required torque for the knife holder mounting bolts is 39 Nm (also see the table under *Replacing and checking the cutting knife mountings*).

ORIGINAL INSTRUCTION
PART A: Basic machine
Shredder G Series

8.12.7 Mounting the rotor knives

 **WARNING**



**Danger of cutting caused by sharp knives, even when the rotor is at a standstill.
Serious injury, particularly to hands and fingers, can result.
Wear protective gloves.**

HINT



The cutting knives, in particular the rotor knives, should only be sharpened or replaced in sets. There is a danger of balance error if a combination of rotor knives from different knife sets is used.

Proceed as follows:

- ↓ Clean the knife supporting surface and the hole on the knife holder
- ↓ Insert sharp knife or turn old knife and push against the knife holder surface.
- ↓ Put in the knife fixing bolt (DIN912 – M12x40 – 12.9) and the washer (DIN433 – 13 – 300HV).
- ↓ Screw in the mounting screws and tighten lightly first
- ↓ **Make sure that the knife fits planar in the seat**
- ↓ Tighten the knife fixing bolts using a torque wrench.

The required torque for all knife mounting bolts is 120 Nm (also see the table under *Replacing and checking the cutting knife mountings*).

- ↓ **Check whether the cutting gap is correct and whether the cutting knives do not collide as the rotor turns.**

TIP



**Rotor knives from VIRTUS are reversible and have four symmetrical cutting edges.
This makes it possible to turn the knives and only to sharpen after every fourth knife change.**

- ↓ Remove tools and other objects from the cutting chamber.
- ↓ Put back screen and fix it
- ↓ Switch on the shredder for a short time without grinding material and listen for noises. If you hear unusual noises, determine the cause and eliminate it.

ORIGINAL INSTRUCTION
PART A: Basic machine
Shredder G Series

8.12.8 Mounting the stator knives

! WARNING



Danger of cutting caused by sharp knives, even when the rotor is at a standstill.
Serious injury, particularly to hands and fingers, can result.
Wear protective gloves.

Proceed as follows:

Illustration:

- (1) Stator knife
- (2) Knife fixing screws
- (3) Knife holder
- (4) Cover plates
- (5) Knife adjusting screw for pushing
- (6) Knife adjusting screw for pulling
- (7) Cover plate fixing screws

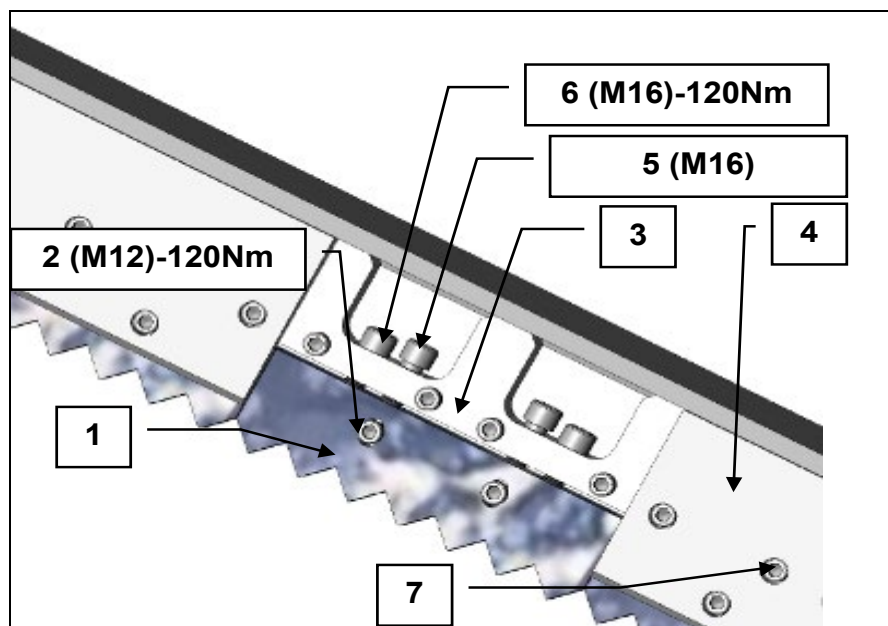

- ↓ Clean the knife supporting surface and the holes on the knife holder
- ↓ Insert sharp knife or turn old knife.
- ↓ Put in the knife adjusting bolts for pushing and adjust them roughly
- ↓ Put in the knife adjusting bolts for pulling and tighten lightly first
- ↓ **Adjust the gap between rotor and stator knife to 0.8-1.0 mm by using the adjusting bolts.**
- ↓ Tighten constant both knife adjusting bolts for pulling by using a torque wrench (295Nm).
- ↓ Tighten constant both knife fixing bolts by using a torque wrench (120Nm).

The required torque for all knife mounting bolts M12 is 120Nm
The required torque for all knife adjusting bolts for pulling M16 is 120Nm
(also see the table under *Replacing and checking the cutting knife mountings*).

ORIGINAL INSTRUCTION
PART A: Basic machine
Shredder G Series

- ↓ Turn the rotor by hand
- ↓ **Check whether the cutting gap is correct and whether the cutting knives do not collide as the rotor turns.**



TIP

Stator knives from VIRTUS are reversible and have two symmetrical cutting edges.

This makes it possible to turn the knives and only to sharpen after every second knife change.

- ↓ Put back the cover plates and fix them with the bolts
- ↓ Remove tools and other objects from the cutting chamber.
- ↓ Put back screen and fix it.
- ↓ Switch on the shredder for a short time without grinding material and listen for noises. If you hear unusual noises, determine the cause and eliminate it.

ORIGINAL INSTRUCTION
PART A: Basic machine
Shredder G Series



8.12.9 Sharpening cutting knives

Shredder rotor knives from VIRTUS have four cutting edges. This means they can be turned twice. After that they should be replaced with new ones. Stator knives can be turned two times and can be resharpened as long as you can fix them with the long hole.

TIP



Specialist sharpening of the cutting knives is part of the service offer of VIRTUS.

 WARNING	
	Danger of cutting caused by sharp knives, even when the rotor is at a standstill. Serious injury, particularly to hands and fingers, can result. Wear protective gloves.

HINT



The cutting knives, in particular the rotor knives, should only be sharpened or replaced in sets. There is a danger of balance error if a combination of rotor knives from different knife sets is used.

Proceed as follows:

- ↓ Dismount the cutting knives (see *Dismounting the rotor knives*).
- ↓ Sharpen the cutting knives.
A specialist in accordance with the sharpening plan using particular care should uniformly sharpen the cutting knives mechanically. It is important to make sure that sharpening takes place with small grinding allowance and sufficient coolant supply. The sharpening process is finished when the cutting edge is sharply cut. Not all indentations must be ground out, otherwise the number of possibilities for sharpening is unnecessarily reduced. For the sharpening process, use soft grinding wheels (Quality 40 H or 46 K). Knives, which have grinding cracks, are not to be reused due to danger of breakage during operation.
- ↓ Whet the cutting edges of the cutting knives using a whetstone.
By taking these measures, the service life of the cutting knives can be increased.
- ↓ Set the cutting knives (see *setting the cutting knives*).
- ↓ Mount the cutting knives (see *mounting the stator knives*).

ORIGINAL INSTRUCTION

PART A: Basic machine

Shredder G Series

8.12.10 Setting the cutting knives

⚠ WARNING	
	Danger of cutting caused by sharp cutting knives. Serious injury, in particular to hands and fingers, can result. Wear protective gloves.

Rotor knives for the ZPS series shredder don't have to be adjusted. All adjustments have to be done with the stator knives. To simplify knife setting and shorten standstill periods when replacing the knives, VIRTUS stator knives have four adjusting screws, two for pulling two for pushing the knife. If you have several knife sets, you will also avoid standstill periods of the machine.

Correct and careful setting of the gap between the rotor knives and the stator knives (cutting gap) is an important requirement for the productive capacity of the shredder. Factors for the size of the knife gap are the size of the rotor, the design of the rotor and the material to be ground.

For setting the knives, proceed as follows:

Illustration:

- (1) Stator knife
- (2) Knife fixing screws
- (3) Knife holder
- (4) Cover plates
- (5) Knife adjusting screw for pushing
- (6) Knife adjusting screw for pulling
- (7) Cover plate fixing screws

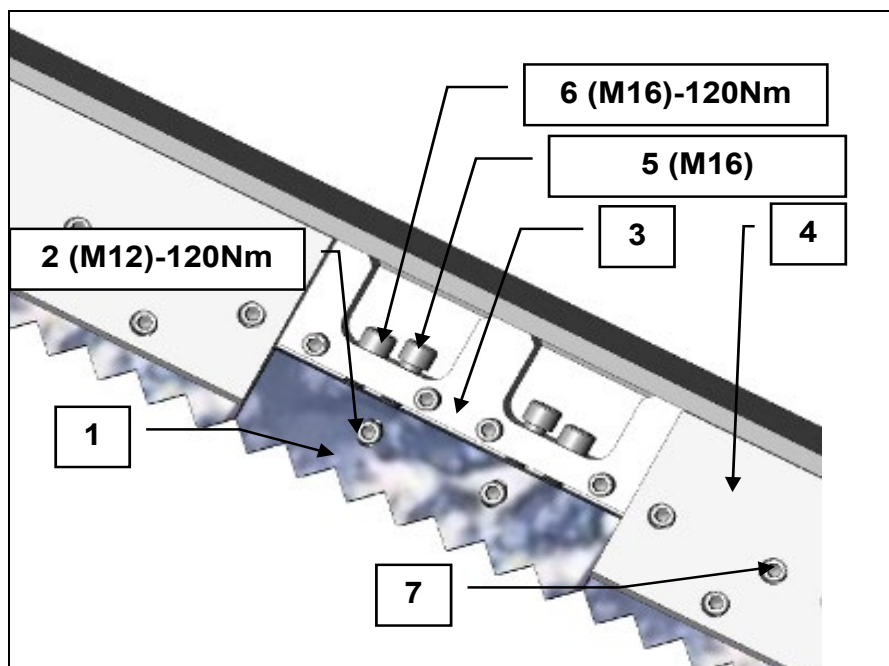

- ↓ Remove old knives (see dismantling the stator knives)
- ↓ Put in the knife adjusting bolts for pushing and adjust them roughly
- ↓ Put in the knife adjusting bolts for pulling and tighten lightly first

ORIGINAL INSTRUCTION

PART A: Basic machine

Shredder G Series

↓ Adjust the gap between rotor and stator knife to 0.8-1.0 mm by using the adjusting bolts.

↓ Tighten constant both knife adjusting bolts for pulling by using a torque wrench (295Nm).

↓ Tighten constant both knife fixing bolts by using a torque wrench (120Nm).

**The required torque for all knife mounting bolts M12 is 120Nm
The required torque for all knife adjusting bolts for pulling M16 is 120Nm**

(also see the table under *Replacing and checking the cutting knife mountings*).



↓ Turn the rotor by hand

↓ **Check whether the cutting gap is correct and whether the cutting knives do not collide as the rotor turns.**

Recommended knife gap: 0.8 mm – 1 mm

↓ Fix the knife cover plates

8.12.11 Transporting and storing the cutting knives

 WARNING	
	<p>Danger of cutting caused by sharp cutting knives. Serious injury, in particular to hands and fingers, can result. Wear protective gloves.</p> <p>Only transport and store the cutting knives packaged. Grease the cutting knives well, so that they do not rust. Protect the cutting edges with doubled cardboard and use adhesive tape to safeguard the knives against slipping out of the sides of the sheath.</p> <p>After unpacking, you must degrease the cutting knives so that they can be gripped safely.</p>

ORIGINAL INSTRUCTION
PART A: Basic machine
Shredder G Series

9 TROUBLESHOOTING

9.1 Machine blocks or switches itself off

No.	Possible causes	Remedy required
9.1.1	Too much feed material.	Reduce grinding material in feed.
9.1.2	Screen blocked.	Clean screen, check condition, if necessary select larger screen perforation.
9.1.3	"V"-belts slip.	Check "V"-belt tension and condition and retighten if necessary or replace.
9.1.4	Knife condition.	Check knives and resharpen or replace if needed.
9.1.5	Cutting gap.	Check cutting gap and set according to the instructions in this operation manual.
9.1.6	Discharge blocked.	Check if discharge conveyor belt is running
9.1.7	Current failure.	Check limit switch for defective contact. Check electrical connection, if necessary tighten limit switch.
9.1.8	Fuse too small.	Fit larger fuse. Only after consulting the service department of VIRTUS.
9.1.9	Rotational direction of rotor.	Check motor and reverse polarity if necessary.
9.1.10	Rotor speed.	Change rotor speed. Only after consulting the service department of VIRTUS.

9.2 Rotor does not grip bulky material

No.	Possible causes	Remedy required
9.2.1	Knife condition.	Check and sharpen if needed according to the instructions in this operation manual.
9.2.2	Protruding bed knife.	Chamfer bed knives; consult with service department of VIRTUS.
9.2.3	Knives not aggressive enough	Fit underlay plates below the knife holders

9.3 Overheating of the grinding material

No.	Possible causes	Remedy required
9.3.1	See 9.1.1 to 9.1.5.	See 9.1.1 to 9.1.5.
9.3.2	Screen perforation too small.	Insert a screen with larger perforation.
9.3.3	Knives wrongly sharpened.	Modify knife finish. Only after consulting the service department of VIRTUS.
9.3.4	Material rubs against the housing wall.	Fit anti-winding device.
9.3.5	Insufficient cooling.	Fit rotor cooling

9.4 Unusual vibrations

No.	Possible causes	Remedy required
8.4.1	Rotor out of balance.	Weigh knives, balance rotor.
8.4.2	Bearing damage.	Check bearings, replace bearings if necessary.
8.4.3	Anti vibration pads defective	Check mounting pads and renew these if necessary.

ORIGINAL INSTRUCTION
PART A: Basic machine
Shredder G Series

9.5 Extreme cutter wear

No.	Possible causes	Remedy required
9.5.1	Bearing damage.	Check bearings, replace bearings if necessary.
9.5.2	Knife finish.	Check knife and sharpen or replace if necessary.
9.5.3	Wrong cutting gap.	Check cutting gap and set according to the instructions in this operation manual.
9.5.4	Foreign matter.	Fit feed device with a metal detector.

9.6 Bearings too hot

No.	Possible causes	Remedy required
9.6.1	Too much grease in bearing.	Reduce amount of grease.
9.6.2	"V"-belts too tight.	Reduce tension.
9.6.3	Rubbing on housing sealing ring.	Check sealing ring, oil or replace.
9.6.4	Bearing damage.	Check bearings, replace if necessary.
9.6.5	No grease in bearing.	Lubricate bearing.

9.7 Too many fines in grinding material

No.	Possible causes	Remedy required
9.7.1	Screen worn.	Renew screen, possibly using manganese steel.
9.7.2	Unsuitable screen perforation.	Replace screen after consulting VIRTUS service department.

9.8 Cutting gap alters during operation

No.	Possible causes	Remedy required
9.8.1	Knife mounting screws not tight.	Retighten using torque wrench in accordance with table in operation manual.
9.8.2	Screw fatigue.	Fit new screws.
9.8.3	Washers deformed.	Insert new washers.
9.8.4	Knife holder surface deformed	Insert new knife holders
9.8.5	Supporting surfaces not clean.	Clean and de-rust supporting surfaces.
9.8.6	Threads in housing worn.	Fit new bushes in housing.

9.9 Screen damage

No.	Possible causes	Remedy required
9.9.1	Screen inserted wrongly.	Fit screen correctly.
9.9.2	Screen support buckled.	Replace screen support.
9.9.3	Screen radius wrong	Correct it.

9.10 Shredder does not start

No.	Possible causes	Remedy required
9.10.1	Limit switches not activated.	Check position of limit switch and correct.
9.10.2	Main and control fuses.	Replace fuse.
9.10.3	Feed device not connected.	Switch on in sequence.
9.10.4	Material jam	Empty shredder before switching on.
9.10.5	Star delta connection.	Correct wiring on motor.
9.10.6	Motor protection switches off.	Check motor relay for correct setting and increase if necessary.
9.10.7	Star delta time relay.	Correct time.

ORIGINAL INSTRUCTION
PART A: Basic machine
Shredder G Series

9.11 Shredder blocks when under load

No.	Possible causes	Remedy required
9.11.1	Feed starts too early.	Start feed only after switch over from star to delta.
9.11.2	Limit switch loose or wrongly set.	Reposition and tighten limit switch.
9.11.3	Fuse defective.	Replace fuse. Fit larger fuse. Only after consulting the service department of VIRTUS GmbH.
9.11.4	Motor fuse switches off - red indicator.	Reduce feed quantity of the grinding material, correct setting, replace fuse.

9.12 Frequent switching off of grinding material in feed device

No.	Possible causes	Remedy required
9.12.1	Current relay switches off.	Correct setting.

9.13 Pusher does not work

No.	Possible causes	Remedy required
9.13.1	pusher doesn't reach his end positions (upper and lower limit).	Check the function of the approximate switch sensors. If the LED indicator doesn't switch on the sensor is out of reach of the limit screws.
9.13.2	Hydraulic tank empty.	Check the hydraulic level of the tank.
9.13.3	Pusher stops at any position.	Check all the 24V relays for loosen connection.
9.13.4	Pusher stops at any position between upper and lower limit.	It could be a fail function or the LOGO inside the control panel, switch of the control panel, wait for ca.5 sec. and switch it on again. If the pusher doesn't go back to the ground position the RAM chip should be replaced.

ORIGINAL INSTRUCTION
PART A: Basic machine
Shredder G Series

10 STORAGE, DISPOSAL, TRANSPORTATION

10.1 Storage



Clean the machine (see Cleaning the machine). Preserve all polished metal surfaces using a suitable rust preventing agent. Store the machine in an enclosed, dry place. Cover the machine completely with a plastic sheet.



10.2 Disposal



Protect the environment.

The disposal of machines, machine components and process materials is partially subject to legal controls. More detailed information is given at the relevant administrative authority (e.g. regional and national Water Conservation Bureaux and Environmental Protection Agencies). Only deposit the material to be disposed of at authorized drop-off points.

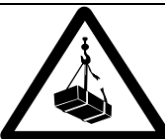
10.3 Transportation

 WARNING	
	<p>Suspended load. Falling loads can cause serious injury or death. Only use a crane or forklift truck, which is suitable for the weight and dimensions of the loads.</p>
	<p>Also use suitable stopping means and pay attention to the gravity centre location. Do not step under the suspended load. Wear a protective helmet in addition to your basic protective gear.</p>

11 HYDRAULIC MAINTENANCE

Before start-up of the machine, hydraulic oil has to be filled into the tank.

The type of oil which should be used depends on your location. We recommend oil of the type DIN 51524 HLP 32 for areas with temperatures below 0°C in the winter and HLP 46 for temperatures of around 30°C in the summer. For extremely hot tropical areas e. g. Thailand, Malaysia, Nigeria etc. we recommend to use HLP 68.

The first oil replacement should be done after 1000 operating hours and than after every 2,000 operating hours. The oil filter has to be replaced too.



HINT

If the oil will not be replaced after this time damage to the hydraulic system can occur, due to overheating of the oil and dirt in the oil. This can lead to a complete standstill of the machine.

When adding hydraulic oil, attention must be paid that the same type of oil is used. If the same type of oil is not available, or if the type used is unknown, the oil in the tank and in the complete hydraulic system has to be removed and the complete system flushed carefully. The system may only be filled with new oil after this has been done. This is necessary to prevent gumming of the valves.

ORIGINAL INSTRUCTION
PART A: Basic machine
Shredder G Series

Check and adjustment of the hydraulic system

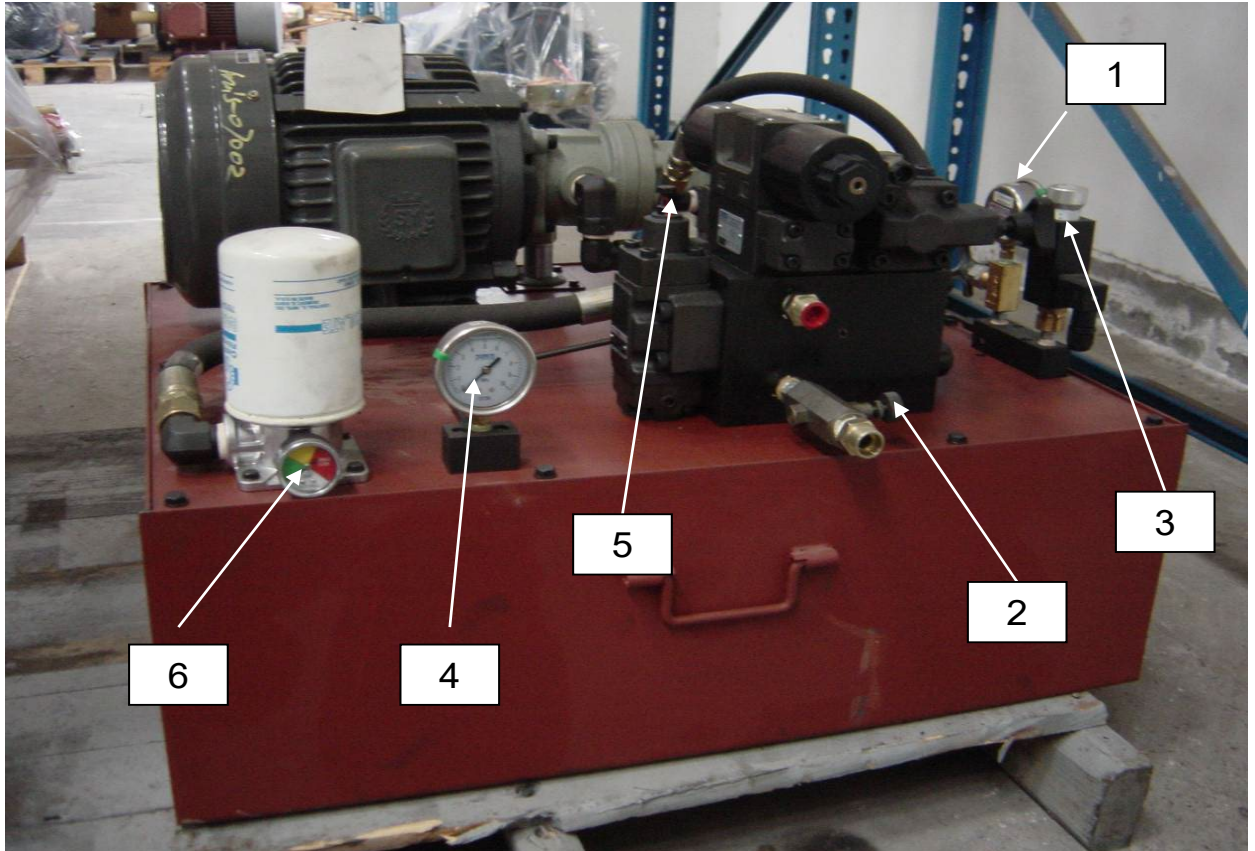

1. Start the machine in automatic running mode and wait for approx. 20 min.
2. When the pusher moves forward the pressure gauge (1) should indicate 0 – 30 bars depends on the adjustment of the throttle check valves (2).
3. When the pusher moves backwards the pressure gauge (1) should indicate 0 – 30 bars depends on the adjustment of the throttle check valves (2).
4. the pressure gauge (1) should indicate 50 – 70 bar at the change over point of the hydraulic cylinders other wise the spill over hand wheel (3) should be adjusted.
5. The pressure gauge (4) should indicate max. 2, 5 MPa other wise the screw of the sequence valve (5) has to be adjusted.
6. The pusher should run upwards in a time – frame of < 10 sec. other wise the throttle check valve (2) has to be adjusted.
7. When the pressure gauge at the oil filter (6) indicates > 5 bar the filter should be replaced.

ORIGINAL INSTRUCTION
PART A: Basic machine
Shredder G Series

Hydraulic liquid recommendation:

Designation to DIN 51 524	HLP 32
Ambient temperature:	-7 to +70°C
Supplier	Name of the oil
ARAL	Aral Vitam GF 32 Aral Vitam HF 32
BP	BP Energol HLP-D 32 BP Energol HLP 32 BP Energol SHF 32
ELF	Efolna 32 Hydrelf 32
ESSO	Nuto H 32 HLPD-Oel 32
FINA	Fina Hydran 32
FUCHS	Renolin MR 10 Renolin B 10
MOBIL	Mobil DTE 24 Mobil DTE 17 Drucköl HLP 32 - C Hydrauliköl HLPD 32
TEXACO	Rando Oil HD A - 32 Rando Oil HD AZ - 32 Alcor Oil DD 32

12 CUSTOMER SERVICE AND SPARE PARTS ORDERS



Should problems occur during operation of the machine or if you have general questions about the machine which this operation manual cannot answer, please do not hesitate to contact us. We would be pleased to help you further in order to solve your problem as quickly as possible.

You can identify the spare parts you require using the spare parts list. Please quote the following information when making your order so that we can deliver the spare parts to you quickly:

- Company name and address.
- Contact person.
- Machine type.
- Machine number.
- Piece number of the spare part.
- Spare part reference.
- Subject number.
- Order quantity.

Virtus Equipment
9120 Centerlinks Commerce DR., Unit 4
Fort Myers, FL 33912

Phone: +1-239-219-1500
Parts@Virtus-Equipment.com

www.Virtus-Equipment.com

TIP



The easiest way to order your spare parts is to copy the spare parts list and to fill in the order amount after the respective spare part.

ORIGINAL INSTRUCTION

PART A: Basic machine

Shredder G Series

13 SPARE PARTS LISTS

13.1 G 40-85

Pos.	Pc	Description/Standard	Part number/SAP	Order
100		Machine complete		
101	1	Standard hopper	ZPS850-10-00	
102	2	PP-scraper side	G 40-85-03-00	
103	1	PP-scraper top	G 40-85-04-00	
	1			
105	1	Lower door	ZPS850-09-00	
106	1	Safety grid side	G 40-85-02-01-00A	
	1	Safety grid side	G 45-150-02-08-00	
107	1	Safety grid back	G 40-85-02-02-00	
108	1	Safety grid back	G 40-85-02-05-00	
109	1	Ram residual chute	G 40-85-17-00	
200		Screen complete (Hydraulic)	21873900	
201	1	Screen		
202	4	Screen support bolts DIN912-M12x50-12.9	80040027	
203	4	Washer DIN125-B-13-140HV	80010740	
204	4	Spring washer DIN127-A-13	80010860	
	4	Nuts DIN934-M12-10.9	80010470	
205	1	Screen support	21874000	
206	2	Cylinder for screen support opening Ø50xØ25x145	80001840	
300	2	Bearing		
301	2	Bearing housing SN320/16Mn	80003190	
302	2	Bearing GB/T288-94/22320	80002990	
303	2	Bearing Cover A	GSH5060-021-03-02-02	
304	1	Bearing Cover B	GSH5060-021-03-02-01	
305	1	Bearing housing cover plate	G 40-85-06-06	
306	3	Sealing GB9877.1-86 J115x140x12	80004030	
307	2	Grease nipple GB1152-89/G1/4	80012460	
308	1	Sleeve Ø150x16	G 40-85-06-02-SA	
309	24	Fixing bolt cover plate DIN912-M10x25-8.8	80009670	
	8	Fixing bolt cover plate DIN912-M10x40-8.8	80011160	
310	1	Bearing fixing plate	G 40-85-06-05	
311	2	Fixing plate bolt DIN933 – M12x40 – 12.9	80009870	
312	2	Washer DIN 125 – A 12	80010740	
400		Drive		
401	1	Motor 37 kW/400V/50Hz		
		Motor 37 kW/460V/60HZ		

ORIGINAL INSTRUCTION

PART A: Basic machine

Shredder G Series

Pos.	Pc	Description/Standard	Part number/SAP	Order
402	1	Gear pulley SPB280-4	80002151	
403	1	Gear pulley taper bush TB 3020-50 (SEW)	80040665	
404	1	Key C 25x290 SEW		
405	4	V-Belt SPB 2240	80040594	
406	1	Motor pulley SPB 280-4	80002151	
407	1	Motor pulley taper bush TB 3020-60	80002420	
408	1	Key Motor shaft		
409	1	Pulley cover	21612400	
410	1	Motor plate	21610100	
411	1	Gear box SEW MC2PLHT03 i=20	80000703	
412	1	Torque arm plate	21566500	
413	1	Rubber bush plate	21566800	
414	1	Rubber bush	80050779	
415	1	Copper bush	80040356	
416	1	Torque arm bolt	21567300	
417	1	Cover plate	21567600	
500	1	E-knife rotor ø387x850	21660600	
501	40/ 60	Rotor knife 34x34x20	80001003	
502	40/ 60	Rotor knife fixing Bolt DIN912 – M12x40 – 12.9	80011210	
503	40/ 60	Washer GB/T1230-13	80040029	
504	40/ 60	Rotor knife holder	80051077	
505	80/ 120	Knife holder fixing bolt DIN912 – M8x25–12.9	80011090	
600	1	Stator knife complete	21616300	
601	3	Stator knife 279x80x30	80001202	
602	6	Fixing Bolt DIN912 – M12x55 – 12.9	80011260	
603	6	Stator knife adjusting bolt for pushing DIN912 – M16x35 – 12.9	80040227	
604	1	Stator knife cover plate	21562700	
	1	Stator knife cover plate left	21562800	
	1	Stator knife cover plate right	21562600	
605	12	Cover plate fixing bolt DIN912–M12x35–12.9	80040034	
606	6	Stator knife adjusting bolt for pulling DIN912 – M16x50 – 12.9	80011291	
700	1	Pusher complete	G 40-85-05-00	
701	2	Arm for pusher	G 40-85-05-04-00	

ORIGINAL INSTRUCTION

PART A: Basic machine

Shredder G Series

Pos.	Pc	Description/Standard	Part number/SAP	Order
702	2	Bearing for arm UCFC212	80003121	
703	8	Fixing bolt for bearing DIN912-M16x80-12.9	80040043	
704	2	shaft for arm	G 45-150-05-03-00	
705	1	Pusher	G 40-85-05-01-00	
706	12	Fixing bolts pusher arm DIN912-M16x90-12.9	80040098	
707	12	Nut DIN6331 – M16 –10	80040058	
708	12	Washer DIN 433-16-300HV	80010760	
709	12			
710	12	Fixing pin GB118-86 A10x60	80040278	
711	1	Scraper	21608500	
712	4	Spring for scraper YI GB1356-78 n=12/d=2/D=12/H=50	80013042	
713	1	Cover plate for scraper	G 40-85-05-03-01-00	
714	2	Upper cylinder bolt	21565750	
715	2	Lower bolt for cylinder fixing	21528000	
716	8	Fixing bolt for cylinder bolt DIN912 – M16x30 – 12.9	80040249	
717	4	Bolt for scraper DIN912 M16x40-12.9	80040603	
800		Hydraulic		
801	2	Cylinder for pusher $\varnothing 35 \times \varnothing 70 \times 400$	80052204	
802		Piping		
803		Connectors		
804	1	Hydraulic unit 3.75kW		
805	1	Set of sealing for cylinders		
806	1	Oil filter 12AT-10-CR		
900		Electrical parts		
901	2	Safety switch AZ15ZVRK-1476-1	80005560	
902	1	Small control box		
903	1	Control panel		
904	2	Proximity switch II0297	80030327	
905	2	Cable for proximity switch EI0200	80030325	

ORIGINAL INSTRUCTION

PART A: Basic machine

Shredder G Series

13.2 G 40-85+

Pos.	Pc	Description/Standard	Part number/SAP	Order
100		Machine complete		
101	1	Standard hopper	ZPS850-10-00	
102	2	PP-scrapers side	G 40-85-03-00	
103	1	PP-scrapers top	G 40-85-04-00	
	1			
105	1	Lower door	ZPS850-09-00	
106	1	Safety grid side	G 40-85-02-01-00A	
	1	Safety grid side	G 45-150-02-08-00	
107	1	Safety grid back	G 40-85-02-02-00	
108	1	Safety grid back	G 40-85-02-05-00	
109	1	Ram residual chute	G 40-85-17-00	
200		Screen complete (Hydraulic)	21873900	
201	1	Screen		
202	4	Screen support bolts DIN912-M12x50-12.9	80040027	
203	4	Washer DIN125-B-13-140HV	80010740	
204	4	Spring washer DIN127-A-13	80010860	
	4	Nuts DIN934-M12-10.9	80010470	
205	1	Screen support	21874000	
206	2	Cylinder for screen support opening Ø50xØ25x145	80001840	
300	2	Bearing		
301	2	Bearing housing SN324	80003180	
302	2	Bearing GB/T288-94-22324	80002980	
303	2	Bearing Cover A	GSH6080-021-03-03-02	
304	1	Bearing Cover B	GSH6080-021-03-03-01	
305	1	Bearing housing cover plate	G 45-150-06-06	
306	3	Sealing GB9877.1-86 J150x180x15	80004040	
307	2	Grease nipple GB1152G1/4-19	80012460	
308	1	Sleeve Ø150x16	G 45-150-06-02-S	
309	24	Fixing bolt cover plate DIN912-M10x30-8.8	80011140	
	8	Fixing bolt cover plate DIN912-M10x45-8.8	80011161	
310	1	Bearing fixing plate	G 45-150-06-05	
311	2	Fixing plate bolt DIN933 – M12x40 – 12.9	80009870	
312	2	Spring Washer DIN127-B 12	80010860	
400		Drive		
401	1	Motor 55 kW/400V/50Hz		
		Motor 55 kW/460V/60HZ		

ORIGINAL INSTRUCTION

PART A: Basic machine

Shredder G Series

Pos.	Pc	Description/Standard	Part number/SAP	Order
402	1	Gear pulley SPB280-4	80002151	
403	1	Gear pulley taper bush TB 3020-50 (SEW)	80040665	
404	1	Key C 25x290 SEW		
405	4	V-Belt SPB 2240	80040594	
406	1	Motor pulley SPB 280-4	80002151	
407	1	Motor pulley taper bush TB 3020-60	80002420	
408	1	Key Motor shaft		
409	1	Pulley cover	21612400	
410	1	Motor plate	21610100	
411	1	Gear box SEW MC2PLHT04 i=20	80013403	
412	1	Torque arm plate	21566500	
413	1	Rubber bush plate	21566800	
414	1	Rubber bush	80050779	
415	1	Copper bush	80040356	
416	1	Torque arm bolt	21567300	
417	1	Cover plate	21567600	
500	1	E-knife rotor ø387x850	21660600	
501	40/ 60	Rotor knife 34x34x20	80001003	
502	40/ 60	Rotor knife fixing Bolt DIN912 – M12x40 – 12.9	80011210	
503	40/ 60	Washer GB/T1230-13	80040029	
504	40/ 60	Rotor knife holder	80051077	
505	80/ 120	Knife holder fixing bolt DIN912 – M8x25–12.9	80011090	
600	1	Stator knife complete	21616300	
601	3	Stator knife 279x80x30	80001202	
602	6	Fixing Bolt DIN912 – M12x55 – 12.9	80011260	
603	6	Stator knife adjusting bolt for pushing DIN912 – M16x35 – 12.9	80040227	
604	1	Stator knife cover plate	21562700	
	1	Stator knife cover plate left	21562800	
	1	Stator knife cover plate right	21562600	
605	12	Cover plate fixing bolt DIN912–M12x35–12.9	80040034	
606	6	Stator knife adjusting bolt for pulling DIN912 – M16x50 – 12.9	80011291	
700	1	Pusher complete	G 40-85-05-00	
701	2	Arm for pusher	G 40-85-05-04-00	

ORIGINAL INSTRUCTION

PART A: Basic machine

Shredder G Series

Pos.	Pc	Description/Standard	Part number/SAP	Order
702	2	Bearing for arm UCFC212	80003121	
703	8	Fixing bolt for bearing DIN912-M16x80-12.9	80040043	
704	2	shaft for arm	G 45-150-05-03-00	
705	1	Pusher	G 40-85-05-01-00	
706	12	Fixing bolts pusher arm DIN912-M16x90-12.9	80040098	
707	12	Nut DIN6331 – M16 –10	80040058	
708	12	Washer DIN 433-16-300HV	80010760	
709	12			
710	12	Fixing pin GB118-86 A10x60	80040278	
711	1	Scraper	21608500	
712	4	Spring for scraper YI GB1356-78 n=12/d=2/D=12/H=50	80013042	
713	1	Cover plate for scraper	G 40-85-05-03-01-00	
714	2	Upper cylinder bolt	21565750	
715	2	Lower bolt for cylinder fixing	21528000	
716	8	Fixing bolt for cylinder bolt DIN912 – M16x30 – 12.9	80040249	
717	4	Bolt for scraper DIN912 M16x40-12.9	80040603	
800		Hydraulic		
801	2	Cylinder for pusher $\varnothing 35 \times \varnothing 70 \times 400$	80052204	
802		Piping		
803		Connectors		
804	1	Hydraulic unit 3.75kW		
805	1	Set of sealing for cylinders		
806	1	Oil filter 12AT-10-CR		
900		Electrical parts		
901	2	Safety switch AZ15ZVRK-1476-1	80005560	
902	1	Small control box		
903	1	Control panel		
904	2	Proximity switch II0297	80030327	
905	2	Cable for proximity switch EI0200	80030325	

ORIGINAL INSTRUCTION

PART A: Basic machine

Shredder G Series

13.3 G 45-120

Pos.	Pc	Description/Standard	Part number/SAP	Order
101	1	Standard hopper	21557950	
102	2	PP-scraper side	21555000	
103	1	PP-scraper top	21554700	
104	1			
105	1	door	21723100	
106	1	Safety grid side	21511000	
	1	Safety grid side	21511050	
107	1	Safety grid back	21569300	
108	1	Safety grid back	21569400	
109	1	Ram residual chute	21559910	
200	1	Screen complete (Hydraulic)	21721700	
201	1	Screen		
202	5	Screen support bolts DIN912-M12x35-8.8	80040027	
203	5	Washer DIN125-B-13-140HV	80010740	
204	5	Spring washer DIN127-A-13	80010860	
	5	Nuts DIN934-M12-10.9	80010470	
205	1	Screen support	21721800	
206	2	Cylinder for screen support opening Ø50xØ25x145	80001840	
300	2	Bearing		
301	2	Bearing housing SN324	80003180	
302	2	Bearing GB/T288-94-22324	80002980	
303	2	Bearing Cover A	GSH6080-021-03-03-02	
304	1	Bearing Cover B	GSH6080-021-03-03-01	
305	1	Bearing housing cover plate	G 45-150-06-06	
306	3	Sealing GB9877.1-86 J150x180x15	80004040	
307	2	Grease nipple GB1152G1/4-19	80012460	
308	2	Sleeve Ø150x16	G 45-150-06-02-S	
309	24	Fixing bolt cover plate DIN912-M10x30-8.8	80011140	
	8	Fixing bolt cover plate DIN912-M10x45-8.8	80011161	
310	1	Bearing fixing plate	G 45-150-06-05	
311	2	Fixing plate bolt DIN933 – M12x40 – 12.9	80009870	
312	2	Spring Washer DIN127-B 12	80010860	
400		Drive		
401	1	Motor 55 kW/400V/50Hz Motor 55KW/460V/60Hz		
402	1	Gear pulley SPC300-4	80001981	

ORIGINAL INSTRUCTION

PART A: Basic machine

Shredder G Series

Pos.	Pc	Description/Standard	Part number/SAP	Order
403	1	Gear pulley taper bush TB 3535-55 (SEW)	80002360	
404	1	Key C28x335 SEW		
405	5	V-Belt SPC2500	80002631	
		V-Belt 60HZ SPC 2430	80040617	
406	1	Motor pulley SPC300-4	80001981	
		Motor pulley 60HZ SPC250-4	80040383	
407	1	Motor pulley taper bush TB 3535-65	80002340	
408	1	Key Motor shaft	none	
409	1	Pulley cover	21658800	
410	1	Motor plate	21657100	
411	1	Gear box SEW MC2PLHT04 i=20	80013403	
412	1	Torque arm plate SEW 55KW	21516500	
413	1	Rubber bush plate	21566800	
414	1	Rubber bush 116x68x100	80050779	
415	1	Copper bush 68x63x100	80040356	
416	1	Torque arm bolt	21567300	
417	1	Cover plate	21567600	
500	1	E-knife rotor ø457x1130		
501	54/ 81	Rotor knife 34x34x20	80001003	
502	54/ 81	Rotor knife fixing Bolt DIN912 – M12x40 – 12.9	80011210	
503	54/ 81	Washer GB/T1230-13	80040029	
504	54/ 81	Rotor knife holder	80051077	
505	108/ 162	Knife holder fixing bolt DIN912 – M8x25 – 12.9	80011090	
600	1	Stator knife complete	21562300	
601	4	Stator knife 279x80x30	80001202	
602	8	Fixing Bolt DIN912 – M12x55 – 12.9	80011260	
603	8	Lower stator knife adjusting bolt for pushing DIN912 – M16x35 – 12.9	80040227	
606	8	Upper stator knife adjusting bolt for pushing DIN912 – M16x50 – 12.9	80011291	
605	16	Cover plate fixing bolt DIN912 – M12x35 – 12.9	80040034	
604	2	Stator knife cover plate	21562700	
	1	Stator knife cover plate left	21562800	
	1	Stator knife cover plate right	21562600	

ORIGINAL INSTRUCTION

PART A: Basic machine

Shredder G Series

Pos.	Pc	Description/Standard	Part number/SAP	Order
700	1	Pusher complete	21555100	
701	2	Arm for pusher	21565300	
702	2	Bearing for arm UCFC212	80003121	
703	8	Fixing bolt for bearing DIN912-M16x80-12.9	80040043	
704	2	Shaft for arm	G 45-150-05-03-00	
705	1	Pusher	21555200	
706	12	Fixing bolts pusher arm DIN912-M16x90-12.9	80040098	
707	12	Nut DIN6331-M16-10	80040058	
708	12	Washer DIN 433-16-300HV	80010760	
709				
710	12	Fixing pin GB118-86 A10x60	80040278	
711	1	Scraper	21556300	
712	4	Spring for scraper YI GB1356-78 n=14/d=2/D=12/H=50	80013042	
713	1	Cover plate for scraper	21556000	
714	2	Upper cylinder bolt	21565750	
715	2	Lower bolt for cylinder fixing	21528000	
716	8	Fixing bolt for cylinder bolt DIN912 – M16x30 – 12.9	80040249	
717	4	Bolt for scraper DIN912-M16x40-12.9	80040603	
800		Hydraulic		
801	2	Cylinder for pusher ø40xø80x470	80050803	
802		Piping		
803		Connectors		
804	1	Hydraulic unit 5.6kW		
805	1	Set of sealing for cylinders		
806	1	Oil filter 12AT-10-CR		
900		Electrical parts		
901	2	Safety switch AZ15ZVRK-1476-1	80005560	
902	1	Small control box		
903	1	Control panel		
904	2	Proximity switch I10297	80030327	
905	2	Cable for proximity switch EI0200	80030325	

ORIGINAL INSTRUCTION

PART A: Basic machine

Shredder G Series

13.4 G 45-150

Pos.	Pc	Description/Standard	Part number/SAP	Order
100		Machine complete		
101	1	Standard hopper	21529050	
102	2	PP-scrapers side	G 40-85-03-00	
103	1	PP-scrapers top	G 45-150-04-00	
104				
105	1	door	21931000	
106	1	Safety grid side	21511000	
	1	Safety grid side	21511050	
107	1	Safety grid back	21512000	
108	1	Safety grid back	21514500	
109	1	Ram residual chute	21549500	
200		Screen complete (Hydraulic)	21932200	
201	1	Screen		
202	6	Screen support bolts DIN912-M12x35-8.8	80040027	
203	6	Washer DIN125-B-13-140HV	80010740	
203	6	Spring washer DIN127-A-13	80010860	
	6	Nuts DIN934-M12-10.9	80010470	
204	1	Screen support	21932300	
205	2	Cylinder for screen support opening Ø50xØ25x145	80001840	
300		Bearing		
301	2	Bearing housing SN324	80003180	
302	2	Bearing GB/T288-94-22324	80002980	
303	2	Bearing Cover A	GSH6080-021-03-03-02	
304	1	Bearing Cover B	GSH6080-021-03-03-01	
305	1	Bearing housing cover plate	G 45-150-06-06	
306	3	Sealing GB9877.1-86 J150x180x15	80004040	
307	2	Grease nipple GB1152G1/4-19	80012460	
308	2	Sleeve	G 45-150-06-02-SA	
309	24	Fixing bolt cover plate DIN912-M10x30-8.8	80011140	
	8	Fixing bolt cover plate DIN912-M10x45-8.8	80011161	
310	1	Bearing fixing plate	G 45-150-06-05	
311	2	Fixing plate bolt DIN933 – M12x40 – 12.9	80009870	
312	2	Spring Washer DIN127-B 12	80010860	
400		Drive		
401	1	Motor 75 kW 50HZ		
		Motor 75 KW 60HZ		

ORIGINAL INSTRUCTION

PART A: Basic machine

Shredder G Series

Pos.	Pc	Description/Standard	Part number/SAP	Order
402	1	Gear pulley SPC375-4	80013385	
403	1	Gear pulley taper bush TB 3535-60 (SEW)	80002350	
404	1	Key C32x345 SEW		
405	4	V-Belt SPC2650	80002632	
		V-Belt 60HZ SPC2500	80040516	
406	1	Motor pulley SPC375-4	80013385	
		Motor pulley 60HZ SPC300-4	80001981	
407	1	Motor pulley taper bush TB 3535-75	80002330	
408	1	Key Motor shaft	none	
409	1	Pulley cover	21530000	
410	1	Motor plate	21527120	
411	1	Gear box SEW MC2PLHT05 i=20	80020331	
412	1	Torque arm plate SEW/75 KW	21516550	
413	1	Rubber bush plate	21566800	
414	1	Rubber bush 116x68x100	80050779	
415	1	Copper bush 68x63x100	80040356	
416	1	Torque arm bolt SEW	21517130	
417	1	Cover plate	21567600	
418	1	Cover SEW 75KW	21516750	
419	6	Rubber bush plate bolts DIN933-M16x50-12.9	80040360	
420	6	Washer DIN433-16	80010760	
422	6	Nut DIN6331 M16 8 发黑	80040058	
500	1	E-knife rotor ø457x1410	21531600	
501	68/ 102	Rotor knife 34x34x20	80001003	
502	68/ 102	Rotor knife fixing Bolt DIN912 – M12x40 – 12.9	80011210	
503	68/ 102	Washer GB/T1230-13	80040029	
504	68/ 102	Rotor knife holder	80051077	
505	136/ 204	Knife holder fixing bolt DIN912 – M8x25 – 12.9	80011090	
600	1	Stator knife complete	21545600	
601	5	Stator knife 279x80x30	80001202	
602	10	Fixing Bolt DIN912 – M12x55 – 12.9	80011260	
603	10	Lower stator knife adjusting bolt for pushing DIN912 – M16x35 – 12.9	80040227	

ORIGINAL INSTRUCTION

PART A: Basic machine

Shredder G Series

Pos.	Pc	Description/Standard	Part number/SAP	Order
604	10	Upper stator knife adjusting bolt for pushing DIN912 – M16x50 – 12.9	80011291	
605	20	Cover plate fixing bolt DIN912 – M12x35 – 12.9	80040034	
606	3	Stator knife cover plate	21562700	
	1	Stator knife cover plate left	21562800	
	1	Stator knife cover plate right	21562600	
700	1	Pusher complete	21520000	
701	2	Arm for pusher	21565300	
702	2	Bearing for arm UCFC212	80003121	
703	8	Fixing bolt for bearing DIN912-M16x80-12.9	80040043	
704	2	Shaft for arm	G 45-150-05-03-00	
705	1	Pusher	21520050	
706	12	Fixing bolts pusher arm DIN912-M16x90-12.9	80040098	
707	12	Nut DIN6331-M16-10	80040058	
708	12	Washer DIN 433-16-300HV	80010760	
709	12			
710	12	Fixing pin GB118-86 A10x60	80040278	
711	1	Scraper	21524800	
712	4	Spring for scraper YI GB1356-78 n=14/d=2/D=12/H=50	80013042	
713	1	Cover plate for scraper	21524050	
714	2	Upper cylinder bolt	21565750	
715	2	Lower bolt for cylinder fixing	21528000	
716	8	Fixing bolt for cylinder bolt DIN912 – M16x30 – 12.9	80040249	
717	4	Bolt for scraper DIN912-M16x40-12.9	80040603	
800		Hydraulic		
801	2	Cylinder for pusher ø50xø100x470	80050804	
802		Piping		
803		Connectors		
804	1	Hydraulic unit 5.6kW		
805	1	Set of sealing for cylinder		
806	1	Oil filter 12AT-10-CR		
900		Electrical parts		
901	2	Safety switch AZ15ZVRK-1476-1	80005560	
902	1	Small control box		
903	1	Control panel		
904	2	Proximity switch II0297	80030327	
905	2	Cable for proximity switch EI0200	80030325	

ORIGINAL INSTRUCTION
PART A: Basic machine
Shredder G Series

13.5 G 45-200

Pos.	Pc	Description/Standard	Part number/SAP	Order
100		Machine complete		
101	1	Standard hopper	21659750	
102	2	PP-scrapers side	G 40-85-03-00	
103	1	PP-scrapers top	G 45-200-04-00	
	1			
105	1	door	21742600	
106	1	Safety grid side	21511000	
107	1	Safety grid back	21654400	
108	1	Safety grid back	21662900	
109	1	Ram residual chute	21659600	
200		Screen complete (Hydraulic)	21743700	
201	1	Screen		
202	8	Screen support bolts DIN912-M12x35-8.8	80040027	
203	8	Washer DIN125-B-13-140HV	80010740	
204	8	Spring washer DIN127-A-13	80010860	
		Nuts DIN934-M12-10.9	80010470	
205	1	Screen support	21743800	
206	2	Cylinder for screen support opening Ø50xØ25x145	80001840	
300		Bearing		
301	2	Bearing housing SN324	80003180	
302	2	Bearing GB/T288-94-22324	80002980	
303	2	Bearing Cover A	GSH6080-021-03-03-02	
304	1	Bearing Cover B	GSH6080-021-03-03-01	
305	1	Bearing Cover C	GSH6080-021-03-04-01	
306	4	Sealing GB9877.1-86 J150x180x15	80004040	
307	2	Grease nipple GB1152G1/4-19	80012460	
308	2	Sleeve	21525250	
309	32	Fixing bolt cover plate DIN912-M10x30-8.8	80011140	
310				
311				
400		Drive		
401	2	Motor 55 kW-4B3/1475rpm/50HZ Motor 55 kW-4B3/1780rpm/60HZ		
402	2	Gear pulley SPC300-4	80001981	
403	2	Gear pulley taper bush TB 3535-55 (SEW)	80002360	
404	2	Key C28x335 SEW		

ORIGINAL INSTRUCTION

PART A: Basic machine

Shredder G Series

Pos.	Pc	Description/Standard	Part number/SAP	Order
405	8	V-Belt SPC2500	80002631	
		V-Belt 60HZ SPC 2430	80040617	
406	2	Motor pulley SPC300-4	80001981	
		Motor pulley 60HZ SPC250-4	80040383	
407	2	Motor pulley taper bush 3535-65	80002340	
408	2	Key Motor shaft	none	
409	2	Pulley cover	21658800	
410	2	Motor plate	21657100	
411	1	Gear box SEW-MC2PLHT04 , i=20,TYPE14	80013403	
		Gear box SEW-MC2PLHT04 , i=20,TYPE23	80020162	
412	2	Torque arm plate SEW 55KW	21516500	
413	2	Rubber bush plate	21566800	
414	2	Rubber bush 116x68x100	80050779	
415	2	Copper bush 68x63x100	80040356	
416	2	Torque arm bolt	21567300	
417	2	Cover plate	21567600	
418	2	Cover SEW 55KW	21516700	
419	12	Rubber bush plate bolts DIN933-M16x50-12.9	80040360	
420	12	Washer DIN433-16	80010760	
422	12	Nut DIN6331 M16 8 发黑	80040058	
423				
500	1	E-knife rotor ø457x1950		
501	96/ 144	Rotor knife 34x34x20	80001003	
502	96/ 144	Rotor knife fixing Bolt DIN912 – M12x40 – 12.9	80011210	
503	96/	Washer GB/T1230-13	80040029	
504	144 96/ 144	Rotor knife holder	80051077	
505	192/ 288	Knife holder fixing bolt DIN912 – M8x25 – 12.9	80011090	
600	1	Stator knife complete	21650700	
601	7	Stator knife 279x80x30	80001202	
602	14	Fixing Bolt DIN912 – M12x55 – 12.9	80011260	
603	14	Lower stator knife adjusting bolt for pushing DIN912 – M16x35 – 12.9	80040227	
606	14	Upper stator knife adjusting bolt for pushing DIN912 – M16x50 – 12.9	80011291	
605	28	Cover plate fixing bolt DIN912 – M12x35 – 12.9	80040034	
604	5	Stator knife cover plate	21562700	
	1	Stator knife cover plate left	21562800	

ORIGINAL INSTRUCTION

PART A: Basic machine

Shredder G Series

Pos.	Pc	Description/Standard	Part number/SAP	Order
	1	Stator knife cover plate right	21562600	
700	1	Pusher complete	21655100	
701	2	Arm for pusher	21565300	
702	2	Bearing for arm UCFC212	80003121	
703	8	Fixing bolt for bearing DIN912-M16x80-12.9	80040043	
704	2	Shaft for arm	G 45-150-05-03-00	
705	1	Pusher	G 45-200-05-01-00	
706	12	Fixing bolts pusher arm DIN912-M16x90-12.9	80040098	
707	12	Nut DIN6331-M16-10	80040058	
708	12	Washer DIN 433-16-300HV	80010760	
709				
710	12	Fixing pin GB118-86 A10x60	80040278	
711	1	Scraper	21656300	
712	4	Spring for scraper YI GB1356-78 n=14/d=2/D=12/H=50	80013042	
713	1	Cover plate for scraper	21656000	
714	2	Upper cylinder bolt	21565750	
715	2	Lower bolt for cylinder fixing	21528000	
716	8	Fixing bolt for cylinder bolt DIN912 – M16x30 – 12.9	80040249	
717	4	Bolt for scraper DIN912-M16x40-12.9	80040603	
800		Hydraulic		
801	2	Cylinder for pusher $\varnothing 50 \times \varnothing 100 \times 470$	80050804	
802		Piping		
803		Connectors		
804	1	Hydraulic unit 5.6kW		
805	1	Set of sealing for cylinder		
806	1	Oil filter 12AT-10-CR		
900		Electrical parts		
901	2	Safety switch AZ15ZVRK-1476-1	80005560	
902	1	Small control box		
903	1	Control panel		
904	2	Proximity switch I10297	80030327	
905	2	Cable for proximity switch EI0200	80030325	

ORIGINAL INSTRUCTION
PART A: Basic machine
Shredder G Series

Illustration: Rotor knife fixing

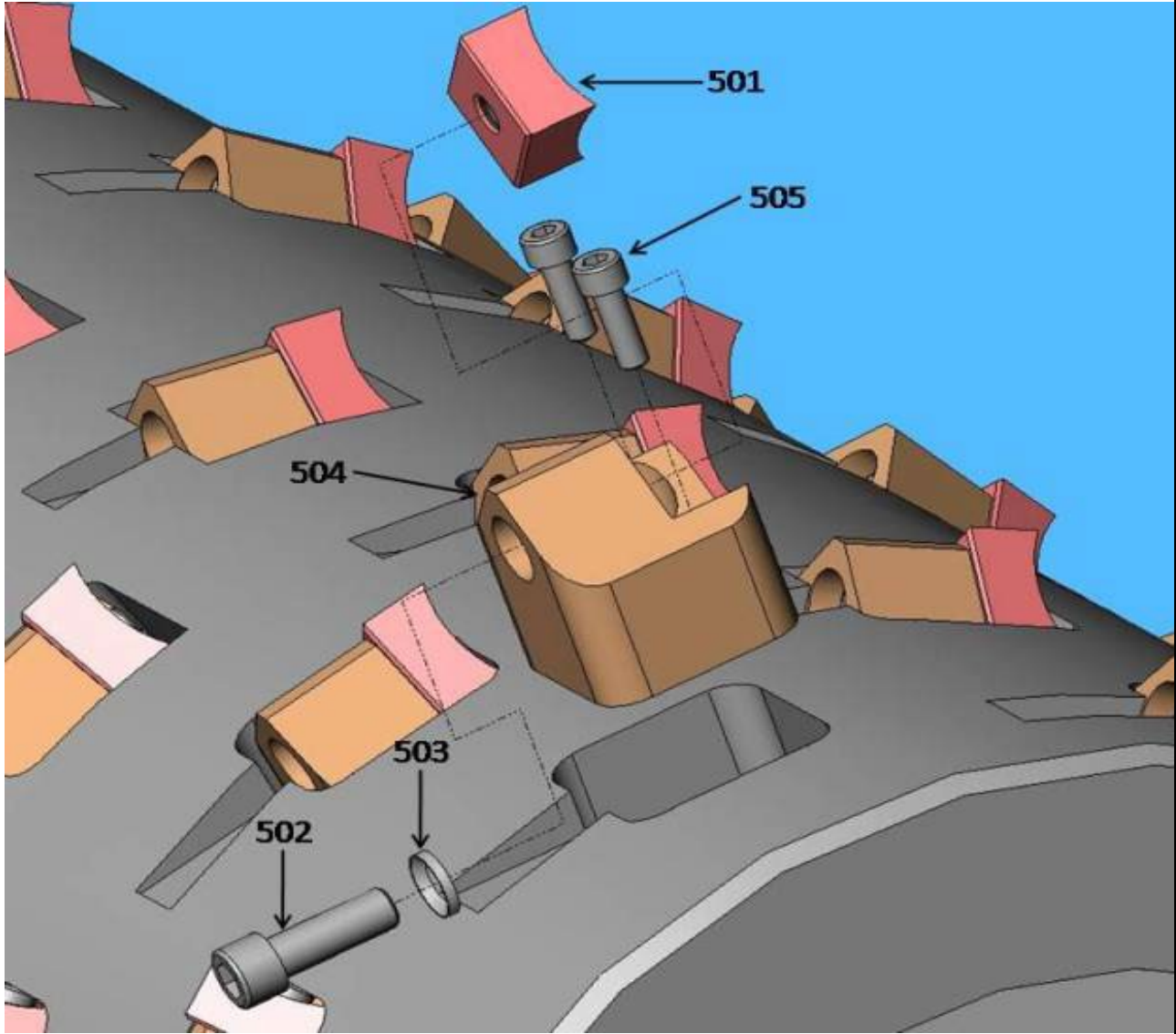

ORIGINAL INSTRUCTION
PART A: Basic machine
Shredder G Series

Illustration: Stator knife fixing

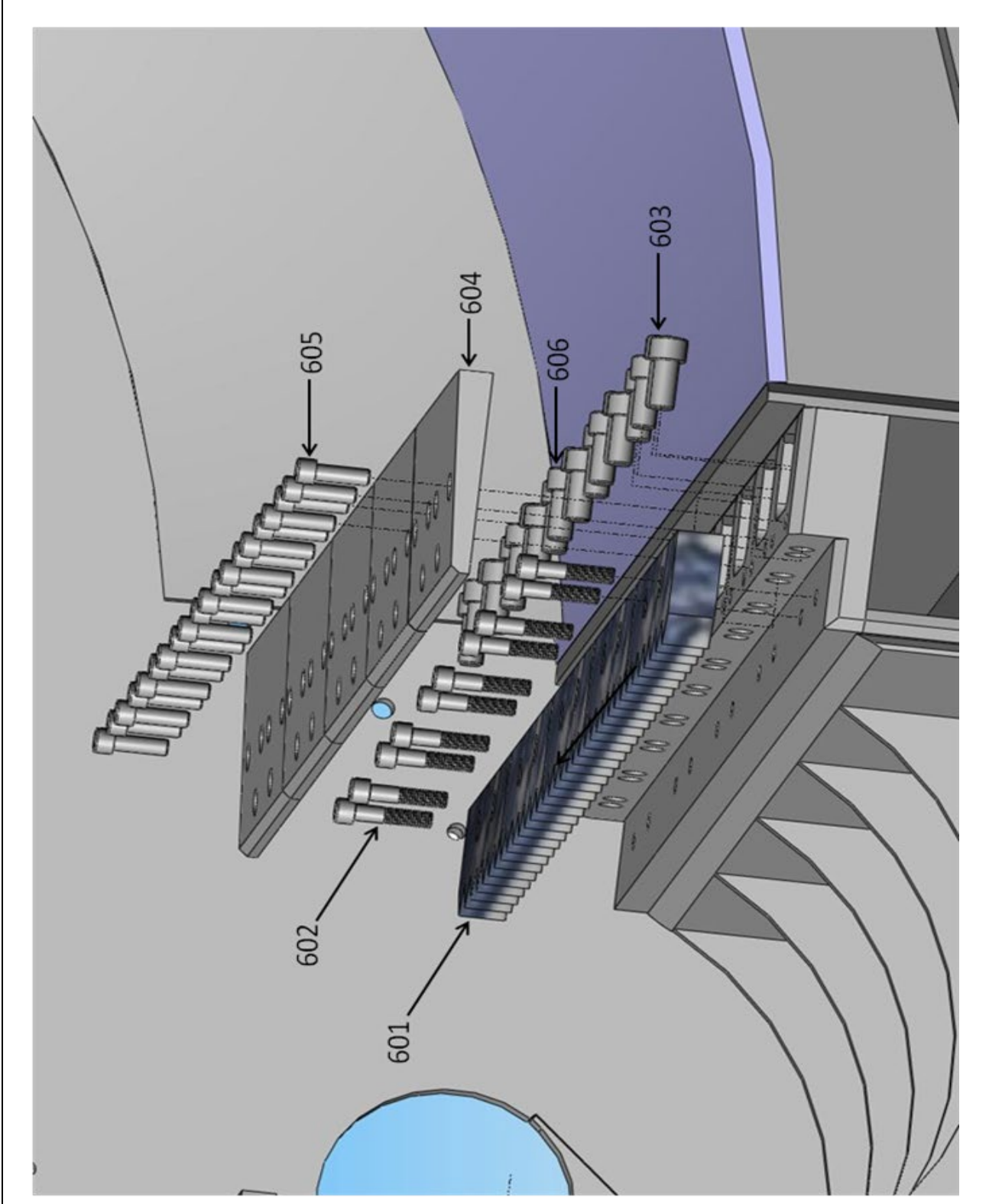

ORIGINAL INSTRUCTION
PART A: Basic machine
Shredder G Series

Illustration: Rotor assembly

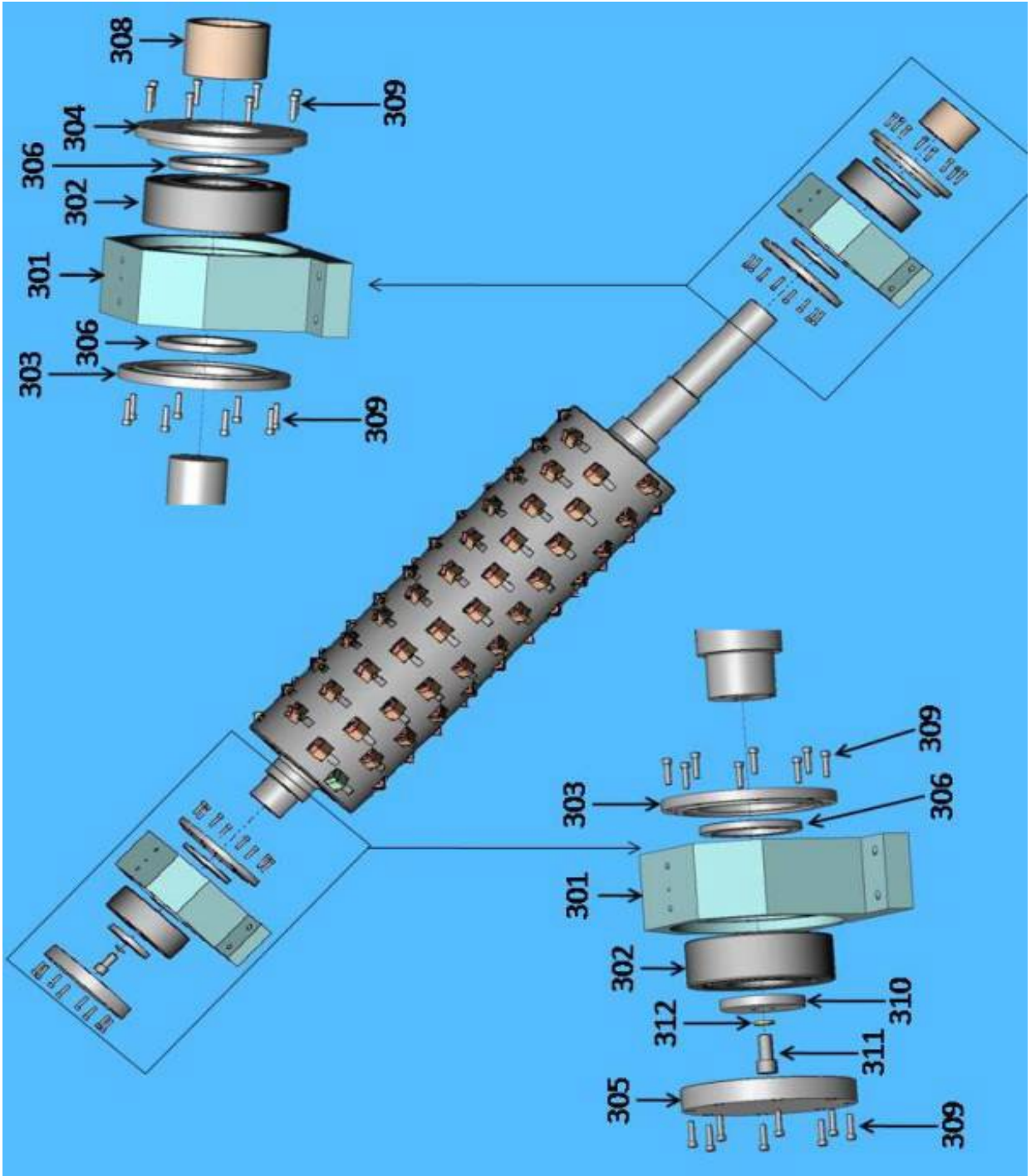

ORIGINAL INSTRUCTION
PART A: Basic machine
Shredder G Series

Illustration: Drive

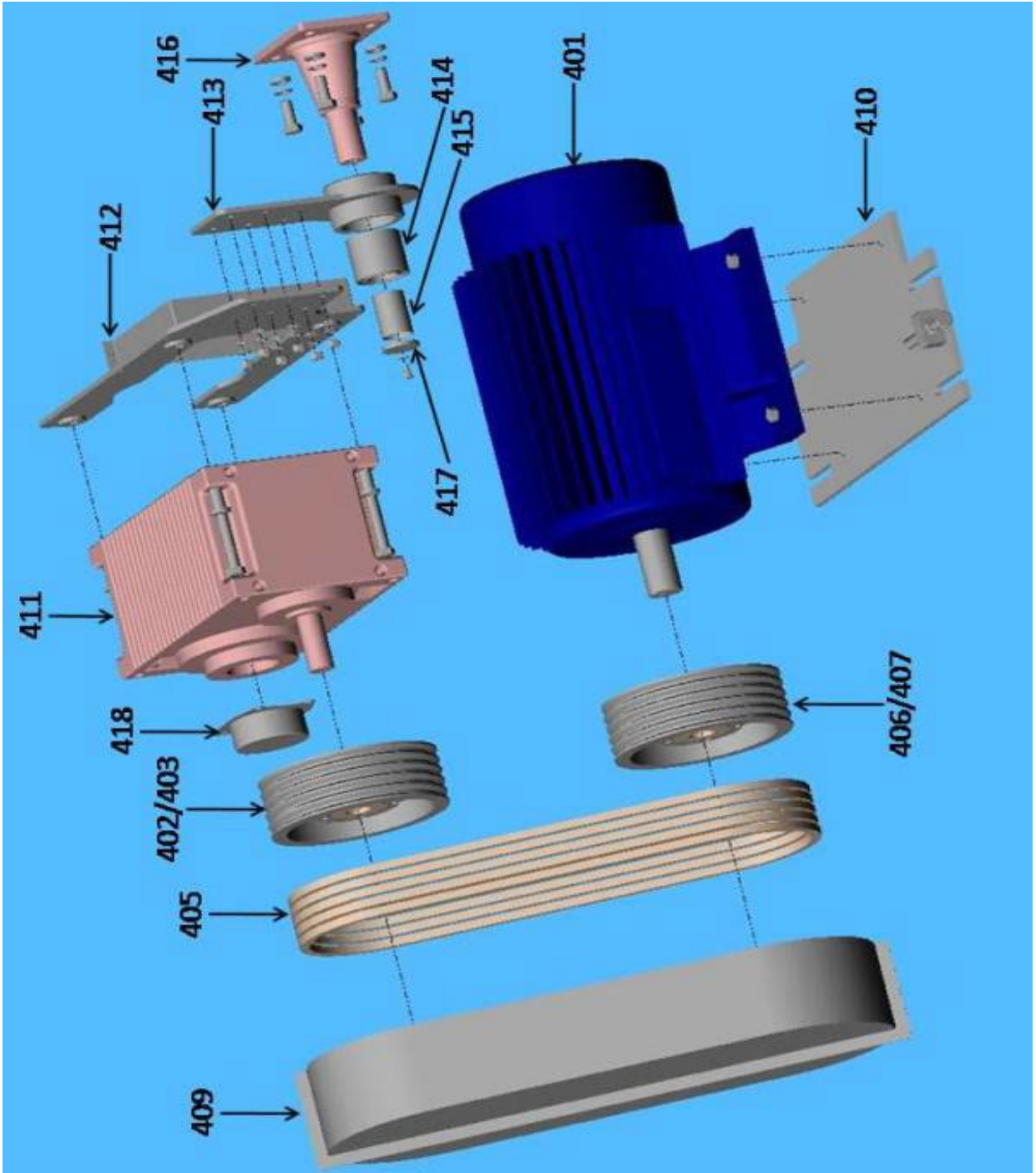

ORIGINAL INSTRUCTION
PART A: Basic machine
Shredder G Series

Illustration: Pusher complete

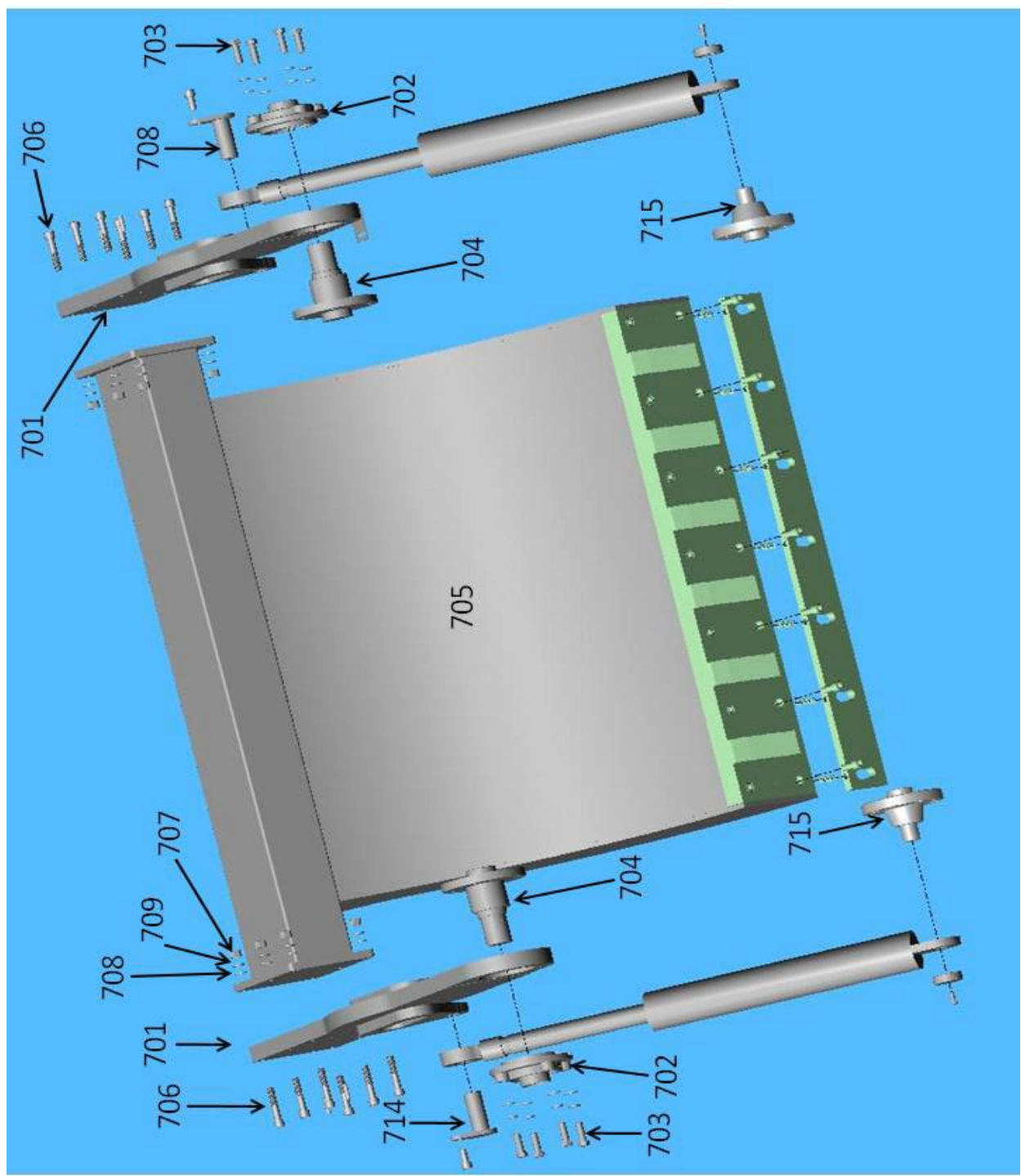

ORIGINAL INSTRUCTION
PART A: Basic machine
Shredder G Series

Illustration: Pusher scraper

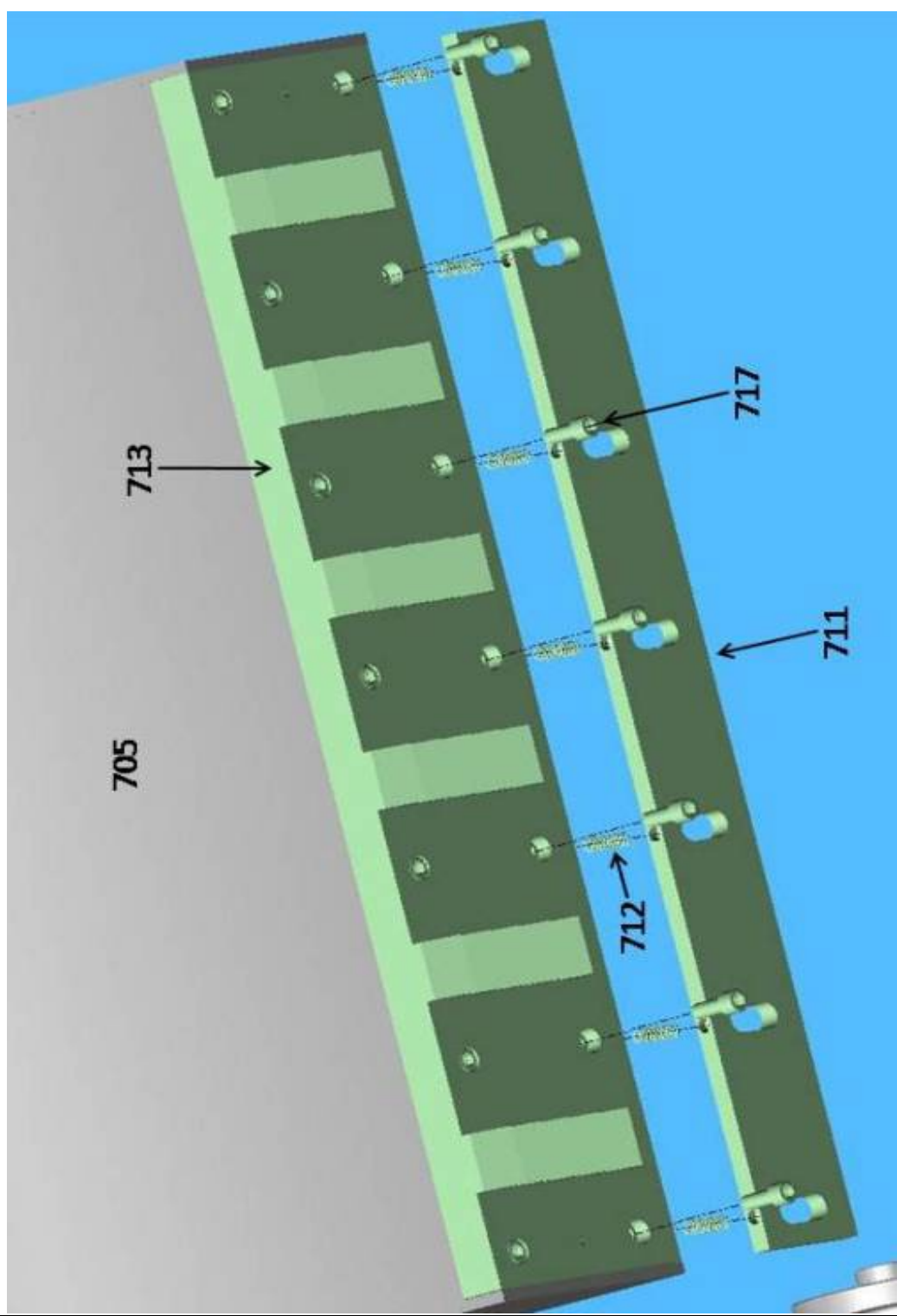

ORIGINAL INSTRUCTION

PART A: Basic machine

Shredder G Series

14 HYDRAULIC UNITS

14.1 SHC-196I for G 40-85/ 45-85+

Action name	VALVE S WINDING					Item	Tube type	max. working pressure	Demolish pressure	maximal pressure in this system	Supply
	YA1	YA2	YA3	YA4	YA5						
Pushing material						1	2SN10 X 420	350bar	1480bar	90bar	1 Jan flt
Pusher back						2	1SN20 X 450	105bar	1400bar	30bar	1 Jan flt
Screen opening						3	1SN20 X 650	105bar	1400bar	10bar	1 Jan flt
Screen Closing											

25	SOLINOID VALVE	DSD-602-6C-DC24-72-ZD	1	7 OCEAN	250	80
24	COOLER	08-100	1	7 OCEAN	20	100
23	THROTTLE AND CHECK VALVE	KC-03	2	7 OCEAN	250	40
22	TEMPERATURE SWITCH	WSS-411(0-100°C)-150L	1	DE LIO		
21	RETURN SUCTION VALVE	RP-110-20-L	1	LI MING	10	100
20	FILLER BREATHER	AB-1163	1	CLC		
19	GAGE LEVEL	LS-3"	1	CLC		
18	PRESSURE SWITCH	PS-02-3-10	1	7 OCEAN		
17	THROTTLE AND CHECK VALVE	PT-04	1	7 OCEAN	250	60
16	PILOT CHECK VALVE	MPD-03-#-1-10	1	7 OCEAN	320	100
15	SOLINOID VALVE	DSD-602-6C-DC24-72-ZD	1	7 OCEAN	250	80
14	SOLINOID VALVE	DSD-600-6C-DC24-72-ZD	1	7 OCEAN	250	160
13	PRESSURE GAGE	2.5"LA 0-10MPA G1/4	1	FIM		
12	PRESSURE GAGE	2.5"LA 0-25MPA G1/4	1	FIM		
11	SEQUENCE VALVE	IR-03-B4	1	7 OCEAN	210	50
10	RELIEF VALVE	BSG-03-1PN-3-DC24-72	1	7 OCEAN	210	100
9	BLOCK	MTB-182H-01	1	7 OCEAN		
8	CHECK VALVE	CG-03-1-10	1	7 OCEAN	250	40
7	CHECK VALVE	RD-112	1	HO GE	250	40
6	SUCTION FILTER	MF-08	1	CLC	10	90
5	SUCTION FILTER	MF-06	1	CLC	10	55
4	LEVEL SWITCH	LEN-160-B	1	SIENG JI		
3	GEAR PUMP	3.2ADPE20/06L03/05H16	1	GILO RUI	200	30/19
2	ELECTRIC MOTOR	5HP X 4P (N0: 00543)	1	QIN CE		
1	TANK	SHC-196H-00	1	7 OCEAN		
ITEM	NAME	TYPE	Qty.	SUPPLIER	RATING (bar)	RATING (bar)
Parameter: Power of system: 3.7KW						
Maximal flow: 38LPM/10LPM						
Maximal pressure: 300bar						

ORIGINAL INSTRUCTION

PART A: Basic machine

Shredder G Series

14.2 SHC-182H for G 45-120/1500/2000

Item	Tube type	Rating working pressure	Demolish pressure	Maximal pressure in this system	Action of valve's winding					
					YA1	YA2	YA3	YA4	YA5	
1	2SN10×420	350bar	1400bar	90bar	+	-	-	-	-	-
2	1SN20×450	105bar	1400bar	30bar	+	-	-	-	-	-
3	1SN20×650	105bar	1400bar	10bar	-	-	-	-	-	-

Item	Action name	Pressure	Flow	Maximal pressure
25	SOLINOID VALVE	100-160	100	250
24	COOLER	RC-03	20	250
23	THERMURLE AND CHECK VALVE	RSSV-411 (0-100°C)-150L	40	250
22	TEMPERATURE SWITCH	BP-110-20-L	10	10
21	RETURN SECTION VALVE	AB-1R3	1	1
20	FILLER BREATHER	LS-3*	1	1
19	GAGE LEVEL	PS-02-3-10	1	1
18	PRESSURE SWITCH	PT-04	1	1
17	THERMURLE AND CHECK VALVE	MPD-03 #1-10	1	1
16	PILOT CHECK VALVE	ISD-012-6C-1024-72-20	1	1
15	SOLINOID VALVE	ISD-012-6C-1024-72-20	1	1
14	SOLINOID VALVE	ISD-012-6C-1024-72-20	1	1
13	PRESSURE GAGE	2.5 LA 0-10MPA G1/4	1	1
12	PRESSURE GAGE	2.5 LA 0-25MPA G1/4	1	1
11	SEQUENCE VALVE	HC-03-B4	1	1
10	RELIEF VALVE	RSG-03-1PW-3-RC24-72	1	1
9	BLOCK	MF-18-2H-01	1	1
8	CHECK VALVE	CGC-03-1-10	1	1
7	CHECK VALVE	RD-112	1	1
6	SECTION FILTER	MF-08	1	1
5	SECTION FILTER	MF-06	1	1
4	LEVEL SWITCH	LEN-150-B	1	1
3	GEAR PUMP	3.24MPF20/60L03/05P/6	1	1
2	ELECTRIC MOTOR	5HP×4(P/N:07B43)	1	1
1	TANK	SHC-182H-00	1	1

Pressure enactment: 30bar (10)

Pressure enactment: 30bar (11)

ORIGINAL INSTRUCTION
PART A: Basic machine
Shredder G Series

15 CLARIFICATION FOR PERSONAL TRAINING

This is to certify that I have attended an in company training for service and operation of the shredder and understand all safety regulations. Further to this I have read and understand the owners' manual.

City	Date	Printed name	Signature

16 ELECTRICAL CONNECTION

The machine should be wired by a qualified electrician.

Please refer to the delivered wiring diagram on the CD

ATTENTION:

The wiring schematics are located in the control panel and on the CD in the event that the control panel is a part of the delivery

ORIGINAL INSTRUCTION
PART A: Basic machine
Shredder G Series

17 DIMENSIONS OF STANDARD MACHINES

17.1 G 40-85

Drawing not scaled; in doubt please ask		ZSS850-E	
Customer		Project	
Confirm		No.	
Date		Sheet 1 of 1	
First Angle		Zerna Machinery&Recycling Technology&Engineering	

Name	Shredder
Design	Customer
Appr.	Sales
Rev.	Date

ORIGINAL INSTRUCTION
PART A: Basic machine
Shredder G Series

17.2 G 40-85+

Technical Data:
 1) Motor: 55Kw
 2) E rotor(d=457mm)
 3) Rotor speed n=74r/min
 4) 60 pcs rotor knife(34x34x20)
 5) 1x3 pcs stator knife(279x80x30)
 6) Hydraulic system: 3.75kw
 7) The biggest space of chamber:800x730

Name	Shredder	Drawing not scaled in doubt please ask	Dwg No.	ZSS850(55KW)-E
Design	Customer	Customer Confirm	Project No.	Sheet 1 of 1
Appr.	Sales	Date	Zemo Machinery&Recycling Technology(Shanghai)Co., Ltd.	
Rev.	Date	First Angle		

ORIGINAL INSTRUCTION
PART A: Basic machine
Shredder G Series

17.3 G 45-120

	Drawing not scaled; in doubt please ask	ZSS1200-E
Name Shredder	Project No.	Sheet 1 of 1
Design	Customer Confirm	Date
Appr.	Sales	Date
Rev.	Date	Date
	First Angle	Zerna Machinery & Recycling Technology (Shanghai) Co., Ltd.

ORIGINAL INSTRUCTION
PART A: Basic machine
Shredder G Series

17.4 G 45-150

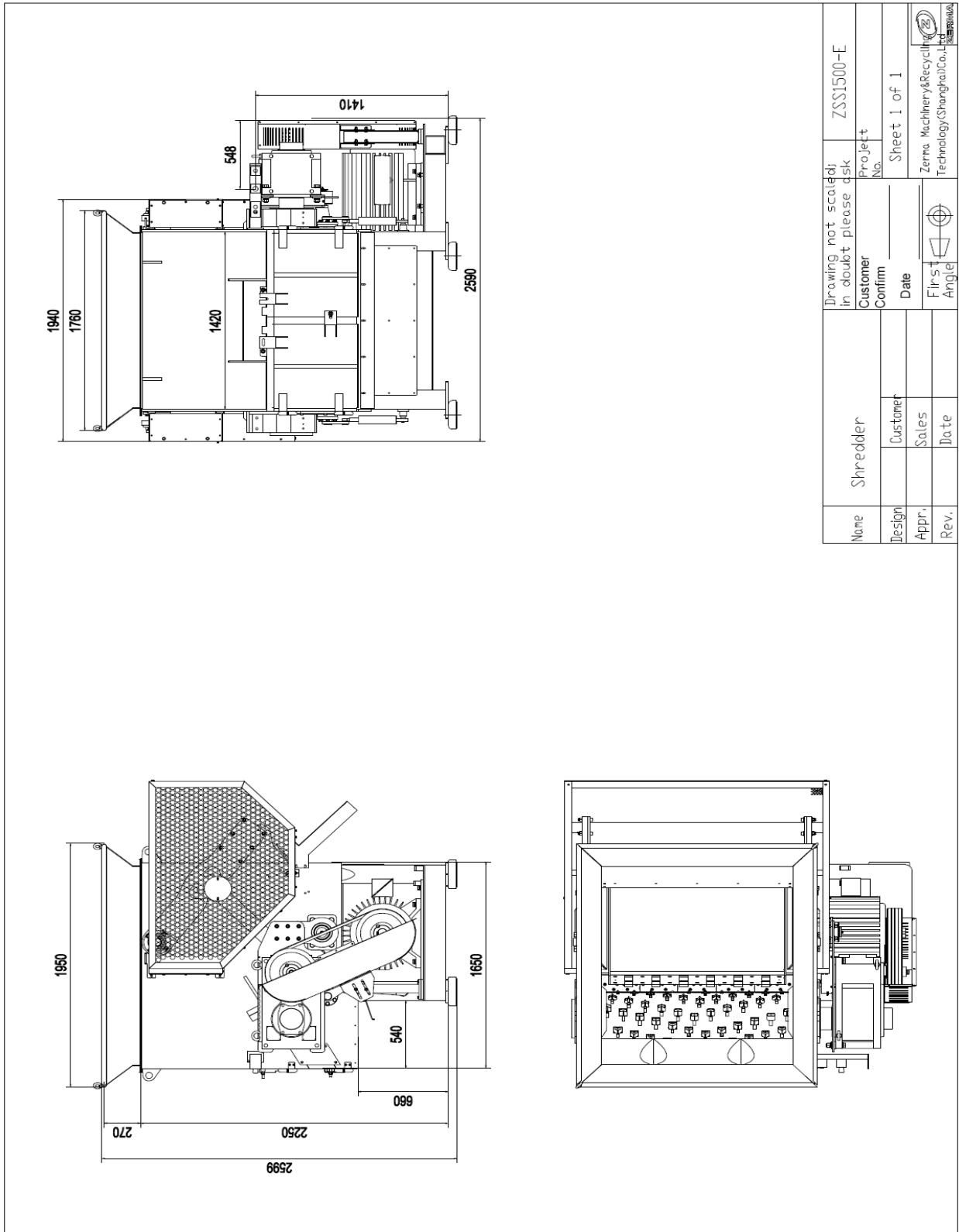

ORIGINAL INSTRUCTION
PART A: Basic machine
Shredder G Series

17.5 G 45-200

Name	Shredder	Drawing not scaled; in doubt please ask		ZSS2000-E			
Design	Customer	Confirm	Date	Project No.	Sheet 1 of 1		
Appr.	Sales	Date	Firs Angle	Zerna Machinery&Recycling Technology(Shanghai)Co.,Ltd			
Rev.	Date						

18 ADDITION

Delivery documentation

ATTENTION:

The wiring schematics are located in the control panel in the event that the control panel is a part of the delivery



Virtus Equipment

9120 Centerlinks Commerce Dr., Unit 4
Fort Myers, FL 33912

239-219-1500

Parts@Virtus-Equipment.com

www.Virtus-Equipment.com