

# OPERATING MANUAL

## H60/80 AND H70/100 SERIES

---



---

### **Virtus Equipment**

9120 Centerlinks Commerce Dr., Unit 4  
Fort Myers, FL 33912

239-219-1500  
Parts@Virtus-Equipment.com

[www.Virtus-Equipment.com](http://www.Virtus-Equipment.com)



The Right Machine for Today's  
Recycling Requirements



---

## Table of Contents

<b>1</b>	<b>Information on this instruction manual</b>	<b>7</b>
<b>2</b>	<b>Technical data</b>	<b>8</b>
2.1	H 60/80&	7
2.2	H 70/100	8
<b>3</b>	<b>General Information</b>	<b>10</b>
3.1	Copyright	10
3.2	Application	10
3.3	Safety	10
3.4	Inspection of goods	10
<b>4</b>	<b>General safety advice</b>	<b>11</b>
4.1	Safe operation of the machine	11
4.2	Use in accordance with the regulations	12
4.3	Liability and Responsibility	14
4.4	Structural changes, spare parts, accessories	15
4.5	Operation manuals from other manufacturers	15
4.6	Noise levels and noise control measures	16
4.7	Work stations	16
<b>4.8</b>	<b>Remaining risks</b>	<b>17</b>
4.8.1	Mechanical dangers	17
4.8.2	Electrical dangers	19
4.8.3	Dangers caused by the control system	19
4.8.4	Thermal dangers	20
4.8.5	Dangers caused by noise	20
4.8.6	Dangers caused by vibration	20
4.8.7	Dangers caused by materials and substances	21
4.8.8	Danger caused by manipulation of the protective devices	21
<b>4.9</b>	<b>Protective devices</b>	<b>22</b>
4.9.1	Safety device for housing flap	21
4.9.2	Safety device for the granulator housing	23
4.9.3	"V"-belts, disk flywheels and shaft protector	25
4.9.4	Splash guard	26
4.9.5	Safety markings	26
4.9.6	Rotor look	27
<b>4.10</b>	<b>Authorized persons</b>	<b>28</b>
<b>4.11</b>	<b>Personal protective gear</b>	<b>29</b>
<b>4.12</b>	<b>Safety measures at the application site</b>	<b>30</b>
<b>4.13</b>	<b>Fire fighting agents</b>	<b>30</b>

**PART A: Basic machine  
Granulator  
H 60/80-70/100**

---

<b>4.14</b>	<b>Cleaning agents</b>	<b>30</b>
<b>4.15</b>	<b>Conduct in case of an emergency</b>	<b>30</b>
<b>4.16</b>	<b>Classification of specific safety advice</b>	<b>31</b>
<b>5</b>	<b>Description of the machine</b>	<b>32</b>
<b>5.1</b>	<b>Grinding material in feed</b>	<b>32</b>
5.1.1	In feed hopper	32
5.1.2	Additional in feed device	32
<b>5.2</b>	<b>Base frame</b>	<b>33</b>
<b>5.3</b>	<b>Drive</b>	<b>34</b>
<b>5.4</b>	<b>Granulator upper section</b>	<b>35</b>
<b>5.5</b>	<b>Granulator lower section</b>	<b>36</b>
5.5.1	Rotor and cutting knives	36
5.5.2	Screen and screen support	38
<b>5.6</b>	<b>Discharge of grinding material</b>	<b>39</b>
<b>5.7</b>	<b>Hydraulic opening device</b>	<b>40</b>
5.7.1	Hydraulic controls	41
<b>6</b>	<b>Initial startup</b>	<b>42</b>
<b>6.1</b>	<b>General Advice</b>	<b>42</b>
<b>6.2</b>	<b>Requirements at the application site</b>	<b>42</b>
<b>6.3</b>	<b>Unloading and installing the machine</b>	<b>43</b>
<b>6.4</b>	<b>Electrical connection</b>	<b>44</b>
<b>6.5</b>	<b>Machine check prior to initial start-up</b>	<b>46</b>
<b>7</b>	<b>Operation</b>	<b>47</b>
<b>7.1</b>	<b>Machine checks before switching on the machine</b>	<b>47</b>
<b>7.2</b>	<b>Switch on machine</b>	<b>47</b>
<b>7.3</b>	<b>Switch off machine</b>	<b>48</b>
<b>7.4</b>	<b>Manual in feed of grinding material</b>	<b>48</b>
<b>8</b>	<b>Maintenance</b>	<b>49</b>
<b>8.1</b>	<b>Safety advice</b>	<b>49</b>
<b>8.2</b>	<b>Maintenance plan</b>	<b>49</b>
<b>8.3</b>	<b>Checking the protective devices</b>	<b>50</b>
<b>8.4</b>	<b>Opening and closing the granulator</b>	<b>51</b>
8.4.1	Opening the granulator upper section	51
8.4.2	Closing the granulator	52
<b>8.5</b>	<b>Cleaning the machine</b>	<b>53</b>
<b>8.6</b>	<b>Replacing the main bearings</b>	<b>54</b>

---

**PART A: Basic machine  
Granulator  
H 60/80-70/100**



---

8.6.1	Dismounting the main bearings	54
8.6.2	Mounting the main bearing	55

**PART A: Basic machine  
Granulator  
H 60/80-70/100**

---

<b>8.7</b>	<b>Lubricating the main bearings</b>	<b>56</b>
8.7.1	Lubrication intervals:	56
8.7.2	Check lubricant quality	56
8.7.3	Replacing or refilling lubricant	56
8.7.4	List of lubricants	58
<b>8.8</b>	<b>Mounting and dismantling the DOKO tensioning element</b>	<b>59</b>
8.8.1	Installation and operation	59
	Tightening torque of the screws: 395Nm	59
8.8.2	Mounting the DOKO tensioning element	60
8.8.3	Dismounting the DOKO tensioning element	61
<b>8.9</b>	<b>Mounting and dismantling TAPER-LOCK tensioning element</b>	<b>62</b>
8.9.1	Table for the tightening torque of the screws	62
8.9.2	Mounting the TAPER-LOCK tensioning element	63
8.9.3	Dismounting the TAPER-LOCK tensioning element	63
<b>8.10</b>	<b>Replacing the screen</b>	<b>64</b>
<b>8.11</b>	<b>Work on the "V"-belts</b>	<b>66</b>
8.11.1	Checking the tension force of the "V"-belt	66
8.11.2	Retensioning and relaxing the "V"-belt	67
8.11.3	Checking "V"-belt condition, replacing "V"-belt	67
<b>8.12</b>	<b>Working on the cutting knives</b>	<b>68</b>
8.12.1	Replacing and checking the cutting knife mountings	68
8.12.2	Checking the condition of the cutting knives	69
8.12.3	Dismounting the cutting knives	69
8.12.4	Mounting the cutting knives	70
8.12.5	Sharpening cutting knives	71
8.12.6	Setting the cutting knives	75
8.12.7	Transporting and storing the cutting knives	78
<b>8.13</b>	<b>Deflection wedge removal</b>	<b>79</b>
<b>9</b>	<b>Troubleshooting</b>	<b>81</b>
9.1	Machine blocks or switches itself off	81
9.2	Rotor does not grip bulky material	81
9.3	Overheating of the grinding material	81
9.4	Unusual vibrations	82
9.5	Extreme cutter wear	82
9.6	Bearings too hot	82
9.7	Too many fines in grinding material	82
9.8	Cutting gap alters during operation	82
9.9	Screen damage	83
9.10	Granulator does not start	83
9.11	Granulator blocks when under load	83
9.12	Frequent switching off of grinding material in feed device	83

---

**PART A: Basic machine  
Granulator  
H 60/80-70/100**

---

<b>10</b>	<b>Storage, disposal, transportation</b>	<b>84</b>
10.1	Storage	84
10.2	Disposal	84
10.3	Transportation	84
<b>11</b>	<b>Hydraulic Maintenance</b>	<b>85</b>
<b>12</b>	<b>Customer service and spare parts orders</b>	<b>87</b>
<b>13</b>	<b>Spare Parts List</b>	<b>88</b>
13.1	H 60/80	88
13.2	H 70/100	90
13.3	Machine complete	95
13.4	Machine section view	96
13.5	S- Rotor	97
13.6	H- Rotor	98
13.7	Stator knife	99
13.8	Deflection wedge	100
13.9	Rotor assembly pulley side	101
13.10	Rotor assembly no pulley side	102
<b>14</b>	<b>Hydraulic Unit</b>	<b>103</b>
14.1	Hydraulic Diagram	103
14.2	Spare parts list hydraulic unit	104
14.3	Hydraulic Unit	105
<b>15</b>	<b>Clarification for Personal Training</b>	<b>106</b>
<b>16</b>	<b>Electrical Connection</b>	<b>107</b>
<b>17</b>	<b>Dimensions Of Standard Machine</b>	<b>108</b>
17.1	H 70/100	107
17.2	H 70/100	108
<b>18</b>	<b>ADDITION</b>	<b>110</b>

---

## **1 INFORMATION ON THIS INSTRUCTION MANUAL**

Author: VIRTUS EQUIPMENT

No part of this operation manual may be reproduced, distributed or used in any shape or form, stored in a data processing system or translated into another language without written permission.

This operation manual serves to help you to get to know your machine and how to make use of its application possibilities in accordance with the regulations.

The operation manual contains important information on how to operate the machine safely, correctly and economically. Following this advice will help you to avoid danger, minimize repair costs and down times and to increase the reliability and durability of the machine.

Before you begin to work on and with the machine, please read the operation manual thoroughly. Only after you have read and understood the contents of this operation manual may you begin work on and with the machine. Keep this operation manual at the application site for future reference.

References to chapters, plans and other documents as well as key markings are written in *italics*.

↓ Instructions on handling are marked in this way.

The machine is designed in modular system and offers a wide spectrum of variations to do justice to your expectations. In order that you receive with the delivery of your machine all the information relevant for you, this operation manual is divided into three parts:

1. Part A: Information of the basic machine.
2. Part B: Plans, operation manuals for systems from other manufacturers etc.

Should you wish to order further operation manuals, please quote the machine number.

We wish you every success with your new machine!



## 2 TECHNICAL DATA

### 2.1 H 60/80

Cutting chamber opening:	Data in mm:	788x695
Rotor dimension:	Diameter in mm:	600
	Width of cut in mm:	800
Rotor type S-3	3-knives-version	
Rotor knives:	Rows of knives:	3
	No. of rotor knives:	3 x 2
Rotor type S-5	5-knives-version	
Rotor knives:	Rows of knives:	5
	No. of rotor knives:	5 x 2
Rotor type S-7	7-knives-version	
Rotor knives:	Rows of knives:	7
	No. of rotor knives:	7 x 2
Rotor type A-4	4-knives-version	
Rotor knives:	Rows of knives:	4
	No. of rotor knives:	4 x 4
Stator knives:	No. of stator knives:	2
	Rows of stator knives:	2
Deflection wedge:		Yes/No
Block knife:	No. of block knives:	2
Rotor speed (50 Hz):	rpm	518
Width:	Data in mm:	1850
Length:	Data in mm:	2300
Height:	Data in mm:	3000
Drive motor:	Power in kW:	75; 90
Screen:	Type and screen hole size dependent on the application and customer requirements.	Hydraulic opening of screen holder
Opening device:	Standard	Hydraulic opening
Machine weight:	In kg	Approx. 4900
Electrical connection data:	markings are attached to the machine	
Noise level: Depends on plant location and type of grinding material!	Without noise equipment, in dB(A):	Approx. 110
	With noise equipment in dB(A):	depends on type of soundproof
Dimensions:	See Layout drawing	

**PART A: Basic machine**  
**Granulator**  
**H 60/80-70/100**



**2.2 H 70/100**

Cutting chamber opening:	Data in mm:	985x804
Rotor dimension:	Diameter in mm:	700
	Width of cut in mm:	1000
Rotor type S-5	5-knives-version	
Rotor knives:	Rows of knives:	5
	No. of rotor knives:	5 x 2
Rotor type S-7	7-knives-version	
Rotor knives:	Rows of knives:	7
	No. of rotor knives:	7 x 2
Rotor type S-9	9-knives-version	
Rotor knives:	Rows of knives:	9
	No. of rotor knives:	9x2
Stator knives:	No. of stator knives:	2
	Rows of stator knives:	2
Deflection wedge:		Yes/No
Block knife:	No. of block knives:	2
Rotor speed (50 Hz):	rpm	411
Width:	Data in mm:	2060
Length:	Data in mm:	2800
Height:	Data in mm:	3420
Drive motor:	Power in kW:	90; 110
Screen:	Type and screen hole size dependent on the application and customer requirements.	Hydraulic opening of screen holder
Opening device:	Standard	Hydraulic opening
Machine weight:	In kg	Approx. 7000
Electrical connection data:	markings are attached to the machine	
Noise level: Depends on plant location and type of grinding material!	Without noise equipment, in dB(A):	Approx. 110
	With noise equipment in dB(A):	depends on type of soundproof
Dimensions:	See Layout drawing	

---

### **3 GENERAL INFORMATION**

#### **3.1 Copyright**

VIRTUS Equipment holds the copyright for these operation instructions, entrusted to the owner of the granulator for his personal use. These contains technical instructions and drawings which are not be copied complete or in part, distributed or used for reasons of unauthorized competition or for informing others.

#### **3.2 Application**

The granulator is designed for size-reduction of plastic material such as PE, PP, PVC etc. The user is responsible for consequences resulting from incorrect operation: This will lead to the loss of the warranty as well as any compensation claims.

#### **3.3 Safety**

The granulator has been constructed in accordance to the general standards of technology and is fitted with safety devices to prevent accidents that could endanger the life or health of the operator. The company operating the unit is responsible for the compliance of the safety regulations. We recommend staff training courses at regular intervals subsequent to initial training during commissioning.

#### **3.4 Inspection of goods**

The goods must be inspected by the purchaser to ensure that the delivery is complete and free from damage during transport. In the event of any queries VIRTUS must be informed with regard to missing items or transport damage. In the event of actual transport damage, written notification including photographs should be made and sent to the transport company as well as sent to VIRTUS immediately after delivery.

---

## **4 GENERAL SAFETY ADVICE**

### **4.1 Safe operation of the machine**

The machine is built according to the state of the art and recognised safety regulations.

It is equipped with protective devices; however there is still the threat of danger in case of incorrect conduct or misuse:

- for the health of the operator and that of other persons,
- for the machine,
- for the environment,
- for material assets belonging to the company and the operator.

All persons involved in:

- transportation and storage,
- start-up and shutdown,
- operation,
- setting and fitting
- maintenance and waste disposal.

of the machine must carefully read and take note of the following advice. However, not only the general safety advice listed in this chapter has to be observed, but also the safety advice which is added specifically in the other chapters.

Failure to heed this safety advice can lead to loss of all compensation claims.

Furthermore, the existing rules and regulations for the prevention of accidents as well as in house company working, operational and safety regulations have to be observed.

## **4.2 Use in accordance with the regulations**

The operational safety of the delivered machine is only guaranteed for use in accordance with the regulations!

This regulation use is only achieved if the following points are observed and fulfilled.

### **Manufacturing process and grinding material**

The granulator is suitable exclusively for the grinding of material, which corresponds to the agreed customer-specific specifications in all points (see *Contract of sale*).

Any other work or design will differ from the specified requirements. VIRTUS will not be held responsible. The specified requirements also include all information found in the owner's manual such as maintenance and service.

Any change in the specifications or requirements must be brought to the attention of VIRTUS.

### **Suction unit**

If emissions occur during grinding of material, which exceed the permissible legal values for contaminants in the air, the granulator may only then be operated when the customer on site has installed a suitable air suction device.

### **Safety device for the in feed hopper**

In the case that your design of granulator does not contain any additional in feed device (e.g. nip roll feed device), the in feed hopper must be safeguarded in a suitable way against persons reaching in or falling in.

### **Connection of the Emergency Stop button**

The machine may only be operated with the installed Emergency Stop buttons. In case no Emergency Stop buttons have been installed, an Emergency Stop button must be mounted on the control cabinet, the second on the material in feed.

**Miscellaneous:**

- The working conditions and instructions specified in this operation manual must be adhered to.
- The machine is not suitable for operation in an explosive environment.
- Faults, which can impair safety, are to be reported immediately and eliminated by a trained and skilled specialist.
- The machine may only be used in the industrial application range.

**General Requirements Safety Information**

- The service and maintenance in this owner's manual must be performed on a regular basis.
- The machine is not designed for operation in a volatile environment.
- Faults that could be a safety factor must be reported immediately and repaired by experienced personal.
- The machine must only be installed in a production type building.

**Known uses not in accordance with the regulations**

Never grind grinding materials, which do not correspond to the agreed customer-specific specifications. If this occurs, there is a danger to persons and the possibility of the machine being damaged.

**Informal Safety Requirements**

The owner's manual should always be located near the machine. New excerpts or additions to the owners' manual must always be replaced to include any safety requirements or environmental requirements.

All safety or caution signs must be visual and easy to read.

---

### **4.3 Liability and Responsibility**

The General Conditions of Sale and Delivery basically apply. These conditions apply no later than the end of the contract. Liability and or responsibility to seller do not apply to the following;

- Equipment is not properly used for its specific application.
- Non-conforming installation, commissioning or service of the machines.
- Operation of the equipment without proper safety guards.
- Not conforming to the directions of the owners' manual regarding transport, storage, installation, commissioning or servicing the equipment.
- Any designs alterations on the machine.
- Any changes on the program logic which can alter the machine operation or electrical function.
- Changes in the logic function.
- In proper maintenance or serving the machines that can lead to extraordinary wear
- In proper serving of equipment
- Spontaneous crashes caused by foreign objects falling into the machine or acts of God

We honour a 12month guarantee valid after delivery under the conditions that originally delivery or original parts from VIRTUS are used or accepted for use in accordance with our owner's manual.

Otherwise the guarantee will be considered invalid. Excluded are wear and tear parts such as knives, screens, drive belts, bearings, etc.

---

#### **4.4 Structural changes, spare parts, accessories**

For reasons of safety, remodelling and modifications to the machine, in particular to the electrical devices, are only permissible by arrangement with the manufacturer!

Replace faulty parts immediately. Only use original spare parts or spare parts from other manufacturers, which correspond, to the original spare parts with regards to function, stress and safety. This applies in particular for reasons of EMC (electro-magnetic compatibility) for electrical components.

The use of unsuitable parts can impair resistance to rays and increase the emission of rays!

If parts are replaced which are relevant for safety, they must be checked afterwards for proper functioning.

Only use accessories, which have been approved by the manufacturer. Use of accessories can change work with the machine. You must therefore observe the additional advice for your work and your safety. Read *Part B: Accessories*, before you commission the machine.

#### **4.5 Operation manuals from other manufacturers**

Integrated in the machine are systems from other manufacturers. When working on or with these systems, please observe the advice in the operation manuals from the respective manufacturer. These operation manuals are enclosed with the machine documentation.



## **4.6 Noise levels and noise control measures**

The H series granulator standard design is without a sound proof enclosure.

The noise level of the granulator at idle speed is approximately 80-85 dB(A).

Especially by rigid materials soundproofing is recommended due to a noise level of up to 120 dB(A) when in operation.

In order not to exceed the noise level of 85 dB(A) is the purchaser required to provide soundproofing.

**The noise level can be affected by foundation static or dynamic, aux. blowers etc. or other additional equipment.** Therefore it is necessary to actually determine if the noise level is directly coming from the machine or another accessory equipment.

VIRTUS offers the following equipment to reduce the noise levels:

- Two piece soundproof box (one piece stationary, one piece moveable) also available with soundproof hopper.
- Walk-in type soundproof enclosure.

## **CAUTION**



**The user or purchaser is responsible for compliance with the instructions and procedures!**

## **4.7 Work stations**

During normal operation, the work station is the station at the in feed of the grinding material.

For maintenance work, the whole area around the machine is at your disposal.

## 4.8 Remaining risks

The machine is constructed so that you are able to operate it safely. Structurally non-avoidable dangers are prevented as well as possible by the protective devices. A certain remaining risk does however always remain! Being aware of these remaining risks of the machine will help you to structure your work more safely and in so doing to avoid accidents.

To avoid danger, please observe in addition the specific safety advice in the individual chapters.

### 4.8.1 Mechanical dangers

<b>Type of danger:</b>	Danger of crushing by heavy parts falling down or falling over.
<b>Activity:</b>	Unloading and transporting the machine or machine components.
<b>Possible consequences:</b>	Serious injury could result.
<b>Preventative measures:</b>	Wear personal protective gear. Follow the instructions in this <i>Operation manual</i> .

<b>Type of danger:</b>	Danger of cutting caused by sharp cutting knives, even when the rotor is stationary.
<b>Activity:</b>	Knife replacement, knife setting, and knife sharpening, other maintenance work.
<b>Possible consequences:</b>	Serious injury, particularly to hands and fingers can result.
<b>Preventative measures:</b>	Wear personal protective gear. Follow the instructions in this <i>Operation manual</i> .

<b>Type of danger:</b>	Danger of crushing when closing the granulator upper section.
<b>Activity:</b>	Maintenance work.
<b>Possible consequences:</b>	Serious injury can result.
<b>Preventative measures:</b>	When closing the granulator upper section, ensure that no persons are in the danger area.

<b>Type of danger:</b>	Tripping over cables and other objects lying around.
<b>Activity:</b>	All activities.
<b>Possible consequences:</b>	Serious injury can result.
<b>Preventative measures:</b>	Lay cables in accordance with the regulations. Keep work station clean and tidy.

<b>Type of danger:</b>	Danger of crushing, cutting and amputation caused by up to 3 minute run down of the rotor.
<b>Activity:</b>	Maintenance work.
<b>Possible consequences:</b>	Serious injury or death can result.
<b>Preventative measures:</b>	The housing upper section must always be tightly locked during operation using the connecting screws. Do not make the run down safety devices ineffective by using technical aids or other manipulations. Never check by hand whether the rotor has come to a stop.

<b>Type of danger:</b>	Danger of pulling in caused by running "V"-belts.
<b>Activity:</b>	All activities.
<b>Possible consequences:</b>	Hair, jewellery etc. can be pulled into the machine. Serious injury can result.
<b>Preventative measures:</b>	Never dismount "V"-belt protection and window.

**4.8.2 Electrical dangers**

<b>Danger:</b>	Direct or indirect contact with live parts in the terminal box.
<b>Activity:</b>	Maintenance work, start-up.
<b>Possible consequences:</b>	Serious injury or death.
<b>Preventative measures:</b>	<p>Trained electricians may only carry out all work on the electrical equipment.</p> <p>If work is necessary on parts, which conduct dangerous voltage, a second person should be called in who can break the power supply in case of emergency.</p> <p>The yellow-marked lines conduct voltage even when the machine is switched off (main switch to 0).</p> <p>Only use original safety fuses with stipulated intensity of current.</p> <p>Faulty electrical components must be replaced immediately.</p> <p>If faults occur in the electrical energy supply, switch machine off immediately.</p> <p>The terminal box must be locked during operation. Before opening the terminal box: Main switch to 0.</p>

**4.8.3 Dangers caused by the control system**

<b>Type of danger:</b>	Danger caused by failure of the Emergency Stop function.
<b>Activity:</b>	All activities.
<b>Possible consequences:</b>	Serious injury or death.
<b>Preventative measures:</b>	It must be guaranteed that failure of an Emergency Stop button is displayed and leads to an immediate stop of the machine.

**4.8.4 Thermal dangers**

<b>Type of danger:</b>	Danger of fire and explosion caused by throwing dangerous objects (e.g. spray cans) into the granulator.
<b>Activity:</b>	Grinding.
<b>Possible consequences:</b>	Serious injury or death can result.
<b>Preventative measures:</b>	Only grind grinding material, which corresponds to the agreed customer-specific specifications in all points.

**4.8.5 Dangers caused by noise**

<b>Type of danger:</b>	Damage to hearing.
<b>Activity:</b>	All activities.
<b>Possible consequences:</b>	Diminished hearing, headaches, impaired balance, and deterioration of concentration.
<b>Preventative measures:</b>	Reduce noise emissions by taking suitable measures. Wear ear protection.

**4.8.6 Dangers caused by vibration**

<b>Type of danger:</b>	Instability of the granulator caused by vibration.
<b>Activity:</b>	All activities.
<b>Possible consequences:</b>	Serious injury can result.
<b>Preventative measures:</b>	Install the machine according to the instructions of this <i>Operation manual</i> and the <i>Assembly drawing</i> .

<b>Type of danger:</b>	Loosening of the cutting knife mountings caused by vibration.
<b>Activity:</b>	All activities.
<b>Possible consequences:</b>	Serious injury can result.
<b>Preventative measures:</b>	Check the cutting knife mountings regularly according to the instructions in this operation manual.

**4.8.7 Dangers caused by materials and substances**

<b>Type of danger:</b>	Inhalation of grinding dust.
<b>Activity:</b>	All activities.
<b>Possible consequences:</b>	Diseases of the respiratory tract etc.
<b>Preventative measures:</b>	Mount a suitable air suction device. Wear breathing equipment if necessary. When cleaning the machine do not blow out grinding dust, use suction instead.

**4.8.8 Danger caused by manipulation of the protective devices**

<b>Type of danger:</b>	Danger of crushing, cutting and amputation.
<b>Activity:</b>	All activities.
<b>Possible consequences:</b>	Serious injury or death can result.
<b>Preventative measures:</b>	Never make the protective devices ineffective. Check the protective devices regularly for proper functioning according to the specifications given in this operation manual.

## **4.9 Protective devices**

The machine may under no circumstances be operated without these protective devices or with faulty or manipulated protective devices. The threaded spindles of the run down safety devices may only be rotated by hand.

### **4.9.1 Safety device for housing flap**

Illustration:  
Safety device  
for housing flap

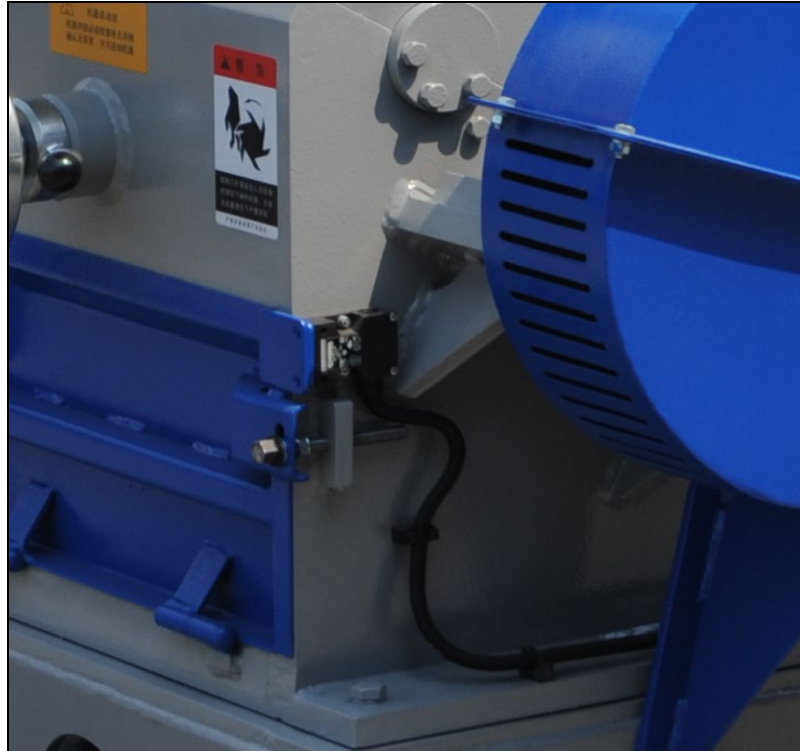

The granulator can only be operated if the housing flap is closed and the threaded spindle is rotated in completely thus deactivating the safety switch. If the housing flap is open, the threaded spindle cannot be rotated in.

If the threaded spindle is rotated out during operation, the safety switch is activated, thus switching off the machine. The run down time of the rotor is bridged by manually rotating out the threaded spindle which takes a certain amount of time, so that this is stationary, when the housing flap can be opened.

#### **4.9.2 Safety device for the granulator upper section**

Illustration:

Safety device upper  
housing

(1) Safety switch

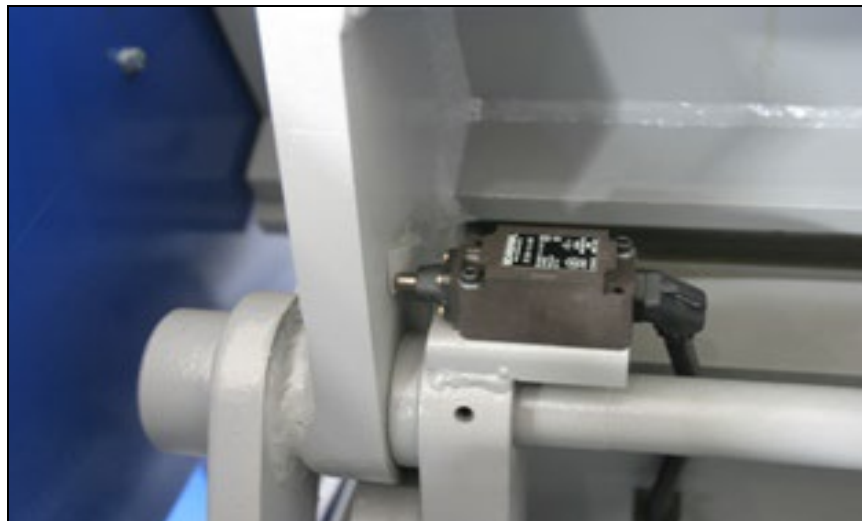

The granulator upper section can be opened by means of a hydraulic system. After switching off the machine a time relay will be activated this prevents that the hydraulic system can be started before the rotor has come to a complete standstill.

Another safety switch is installed on the hinge of the granulator. This prevents the granulator being put into operation when the granulator upper section is opened.

A third safety switch is installed on the hinge of the screen holder. It prevents that the granulator can be started, when the screen holder is lowered.

Illustration:

Safety device screen  
holder

(1) Safety switch





**PART A: Basic machine**  
**Granulator**  
**H 60/80-70/100**

Illustration:  
Opened hopper/  
upper section



#### 4.9.3 "V"-belts, disk flywheels and shaft protector

"V"-belt protection, disk flywheel protection (insofar as a disk flywheel is present) and shaft protector are fixedly connected to the machine. They can be dismantled for installation and maintenance work. However, this may only then be carried out when all rotating parts have come to a complete standstill.

Illustration:  
V-belt cover



If machines are delivered on the request of the customer without drive motors, the operator is obliged to fit and mount the protective devices delivered together with the machine himself in line with the current legal safety regulations.

Illustration:  
Shaft cover

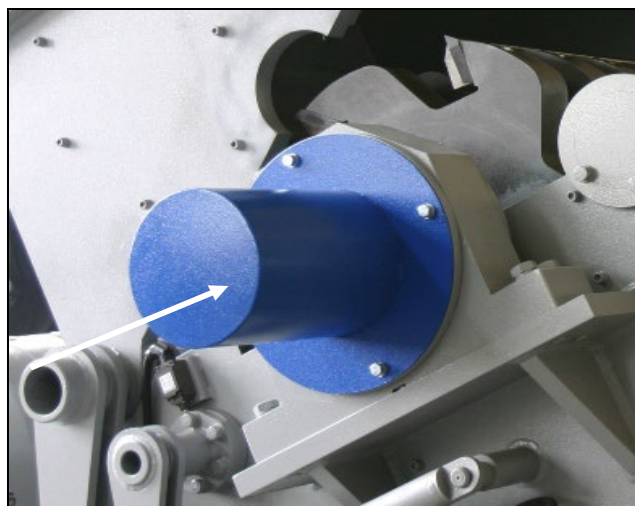

#### 4.9.4 Splash guard

In case that the grinding material is introduced directly via the in feed hopper, the input opening is provided with a splash guard.

Illustration:  
Hopper splash guard

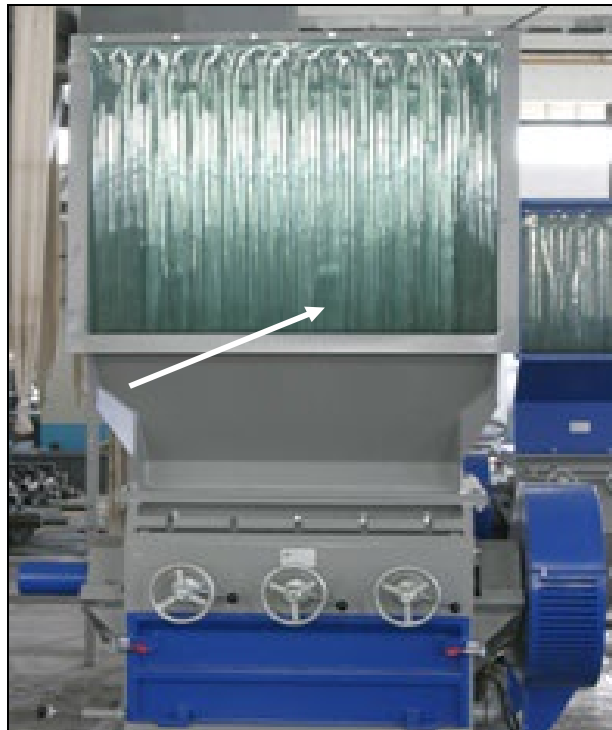

**Attention:**

Fixation of the splash guard curtains must be checked every month.

#### 4.9.5 Safety markings

Safety markings are attached to the machine. If one of these markings becomes detached or is no longer recognisable, it must be replaced. You can order new markings at specialist shops or from us.

**4.9.6 Rotor lock**

Illustration:  
Rotor Lock

- (1) Interlock
- (2) Rotor
- (3) Safety switch for interlock

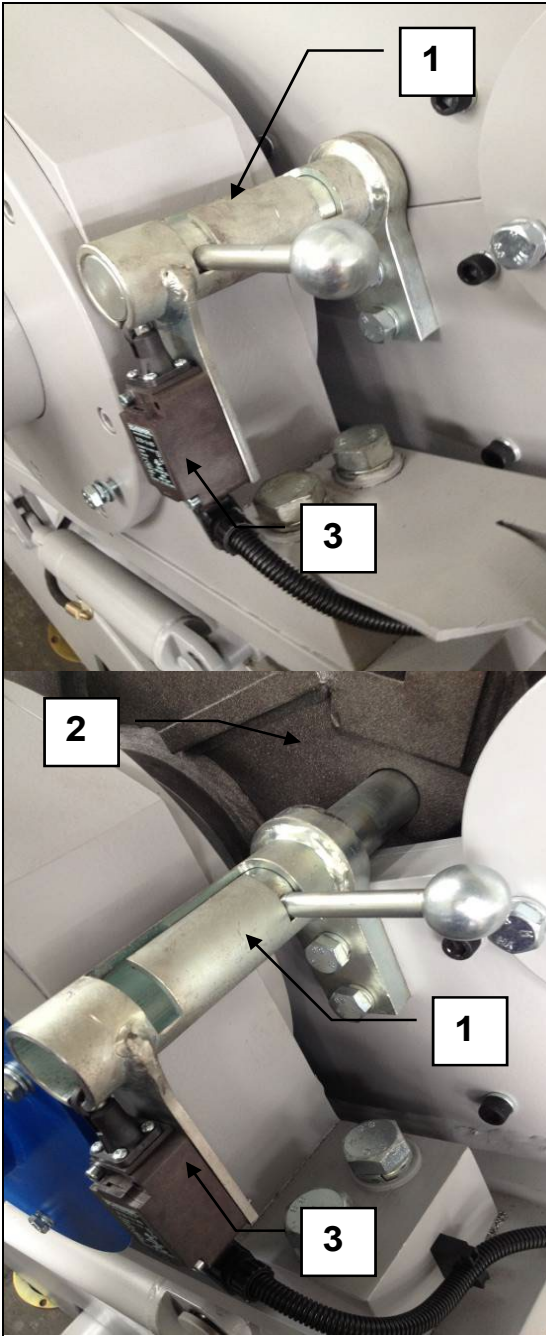

To secure the rotor against turning by knife change or other maintenance work, move the security interlock into the rotor. The interlock is secured by a safety switch what will provide damage to the lock caused by closing the housing

---

#### **4.10 Authorized persons**

Authorized personnel may only carry out work on the machine. Observe the legally permissible minimum age!

As a basic rule, persons who have received training on the machine may only operate the machine.

Personnel, who are still to be trained or receive instruction on the machine, may only work on the machine under constant supervision by an experienced person.

The company operating the machine must make the operation manual accessible to the machine user and ensure that he has read and understood it. Only then may he put the machine into operation.

Responsibility for the different jobs on the machine must be clearly established and adhered to. There must be no unclear areas of authority, as this could endanger the safety of the machine user.

If several persons work on the machine, a detailed division of workstations should be set up.

Trained electricians may only carry out all work on the electrical equipment.

Authorized specialist personnel may only eliminate faults on the control system.

All work related to installation, trained specialist personnel having received instruction on the machine might only carry out fittings and maintenance of the machine.

The operator must make sure that only authorized person's work on the machine. He is responsible for the safety of third persons in the working area of the machine.

#### **4.11 Personal protective gear**

Wear close-fitting clothing. Jewellery and hair must be worn so that they cannot be pulled into the machine by moving parts.

**The following protective gear must be worn when carrying out the following tasks:**

	<b>Safety helmet</b>	<b>Safety boots</b>	<b>Safety gloves</b>	<b>Safety goggles</b>	<b>Ear muffs</b>
Unloading machine.	x	x	x		
Connecting machine.		x			
Operation.		x	x	x	x
Cleaning.		x	x	x	
Maintenance of bearings.		x			
Screen replacement.		x	x		
Maintenance of "V"-belts.		x			
Maintenance of cutting knives.		x	x		
Knife sharpening.		x	x	x	x

If necessary, protect yourself (in addition to the air suction device) with breathing equipment before inhaling substances harmful to the health.

#### **4.12 Safety measures at the application site**

Requirements at the application site: see chapter *Initial Start-up*.  
The machine must be erected horizontally on a horizontal surface and in a stable manner.  
Ensure by means of appropriate in house orders and controls that the environment of the work station is always clean and clear of obstructions.

#### **4.13 Fire fighting agents**

In the case of fire, disconnect the power supply of the machine or pull out the mains plug. Extinguish the fire from a distance of several meters using a fire extinguisher suitable for the machine and the grinding material.

#### **4.14 Cleaning agents**

Only use suitable cleaning agents to clean the machine and in doing so, the advice of the manufacturer is to be heeded. Please be aware that unsuitable cleaning agents (e.g. thinners) can damage the paint of the machine as well as the cables and plastic parts.

#### **4.15 Conduct in case of an emergency**

The machine may only be operated with the installed Emergency Stop buttons. An Emergency Stop button must be mounted onto the control cabinet, the second onto the grinding material in feed.

##### **Emergency Stop:**

- ↓ In case of emergency, immediately press one of the *Emergency Stop buttons*.

## **CAUTION**

**The EMERGENCY STOP must be activated in all situations whereby injury or damage could result!**









##### **Reoperation:**

- ↓ Eliminate cause of Emergency Stop.
- ↓ Unlock *EMERGENCY STOP BUTTON*.
- ↓ Acknowledge fault.  
The machine is now ready for operation again.

#### 4.16 Classification of specific safety advice

The specific safety advices in the following chapters of this operation manual are classified as follows:

 <b>DANGER</b>	
	Indicates an immediately threatening danger. If you do not take avoiding action, death or serious injury will result.
 <b>WARNING</b>	
	Indicates a possibly dangerous situation. If you do not take avoiding action, death or serious injury could result.
 <b>CAUTION</b>	
	Indicates a possibly dangerous situation. If you do not take avoiding action, slight or minor injury could result.

This safety advice refers to the remaining risks for certain working steps and helps you to work safely with the machine. In addition to the safety advice above, there are also the hint and the tip.

#### **HINT**



Indicates a possibly harmful situation. If you do not take avoiding action, the machine could be damaged.

#### **TIP**



Indicates application tips and other particularly useful information.



## **5 DESCRIPTION OF THE MACHINE**



### **5.1 Grinding material in feed**



The grinding material can be fed into the granulator in the following ways:

- Manual in feed of the grinding material directly into the in feed hopper.
- Manual in feed of the grinding material with the help of an additional in feed device (e.g. nip roll feed device).
- Automatic in feed of the grinding material by means of an additional in feed device (e.g. conveyor belt).

#### **5.1.1 In feed hopper**

The grinding material in feed ensues via an in feed hopper, which is formed so that the grinding material can be delivered correctly and safely. A splashguard at the input opening prevents thrown-back parts being able to escape. The grinding material in feed can take place manually or with the help of an additional in feed device.

 <b>DANGER</b>	
	<b>Material fly back can occur out of the hopper opening. Serious injury or death can result. Do not remove the splash guards from hopper or throw in material larger than the hoppers capacity Splash guards has to be closed during grinding</b>

 <b>WARNING</b>	
	<b>If using a hopper with side infeed or pipe hopper: The material shall be shorter than 80% of the side arms length!</b>

#### **5.1.2 Additional in feed device**

If your machine has an optional in feed device such as roller feeder or conveyor belt please refer to the additional information about the accessories in the appendix.

**5.2 Base frame**

Illustration:

- (1) Base frame
- (2) Terminal box
- (3) Hydraulic system
- (4) Drive motor
- (5) Machine housing
- (6) Suction trough
- (7) Pads

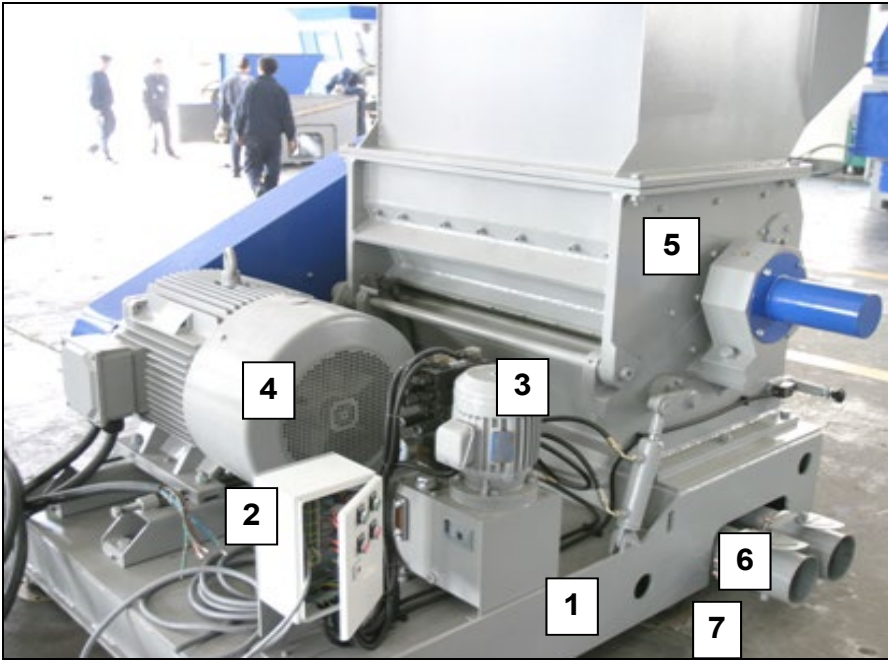

The machine housing, the suction trough, the drive motor, the hydraulic system and the terminal box, for the electrical connections, are mounted on the base frame.

The base frame is equipped with a sufficient number of vibration and noise muffling mounting pads.

### **5.3 Drive**

The drive of the rotor ensues by means of an electric motor via "V"-belts. The motor, which is mounted on sliding rails or a motor plate, can be adjusted for regulating the tension of the "V"-belts by means of tensioning screws. The "V"-belt pulley is attached with a special tensioning element to the motor shaft.

Illustration:  
Drive Motor

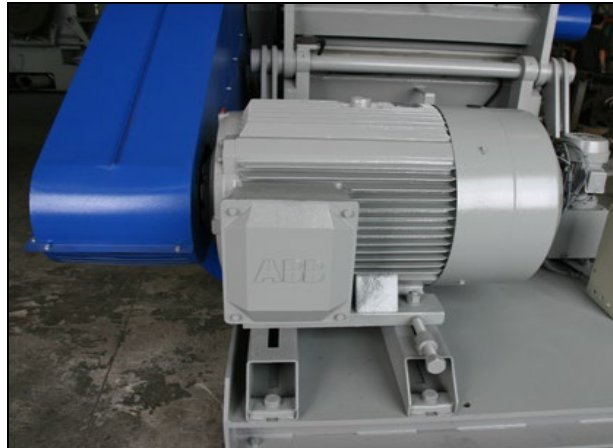

Please observe the operation manual from the manufacturer!

**5.4 Granulator upper section**

The granulator upper section can be opened or pivoted upwards for maintenance work and for cleaning. It is connected with the granulator lower section by means of a joint. Opening and closing ensues by means of a hydraulic system. The in feed hopper mounted on the granulator upper section pivots with the granulator upper section.

Illustration:  
Granulator upper section  
(opened)

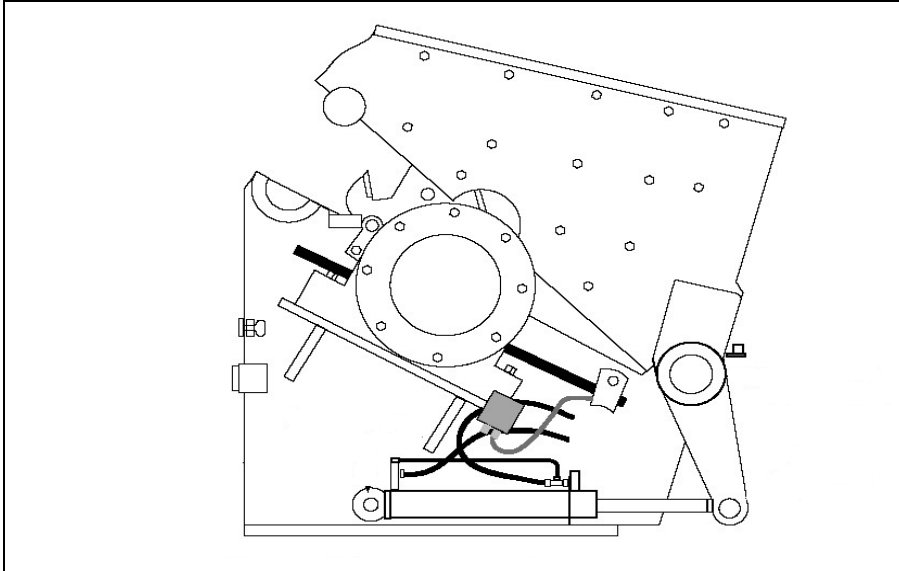

In addition, an anti-winding device is also integrated on the granulator upper section. This prevents foil strips, for example, becoming wrapped around the rotor axis and thus causing operational faults.

## 5.5 Granulator lower section

The granulator lower section and the drive are mounted onto the base frame. The rotor is arranged on bearings in the granulator lower section. The bearings lie outside the grinding chamber and are sufficiently sealed off against penetrating dirt. The stator knives which are installed in the granulator lower section are easily accessible and simple to install and dismantle. In the upper section the deflection wedge and the third stator knife are installed. The ground material falls through a screen into the suction trough mounted underneath the rotor and can be sucked off from there.

### 5.5.1 Rotor and cutting knives

Illustration:

- (4) Stator knives
- (5) Rotor knives
- (6) Deflection wedge
- (7) 3. Stator knife  
(Block knife)

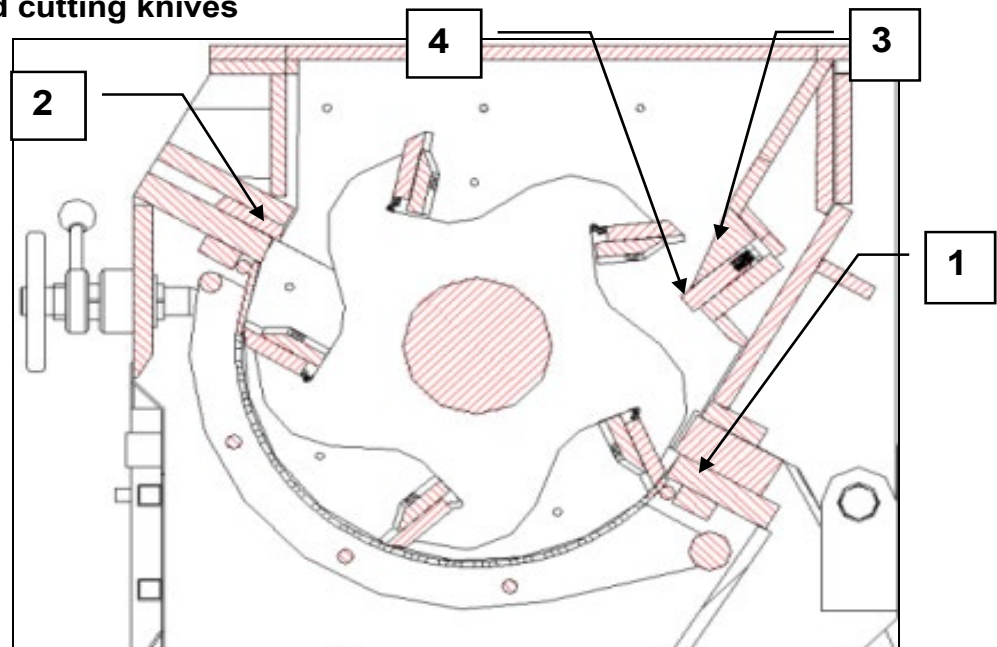

The material is ground between the knives assembled on the rotor and the stator knives which are mounted in a fixed position in the housing.

All rotors are equipped with either a single or a v-shaped scissor cut to decrease the power consumption and to increase the capacity of the machine, while avoiding high amp-peaks.

The design of the rotor has a significant influence on the quality of the grinding process and its results. The rotor construction, the type of knife mounting and the number of knives have all been exactly matched to your task allocation.

**PART A: Basic machine  
Granulator  
H 60/80-70/100**

The rotor is arranged on roller bearings, which are situated outside the housing. The "V"-belt pulley is attached by means of a taper bush to the rotor axis. The rotor is dynamically counter balanced and has vibration-free concentricity. The rotor is accessible after opening the granulator upper section.

Illustration:  
Bearing

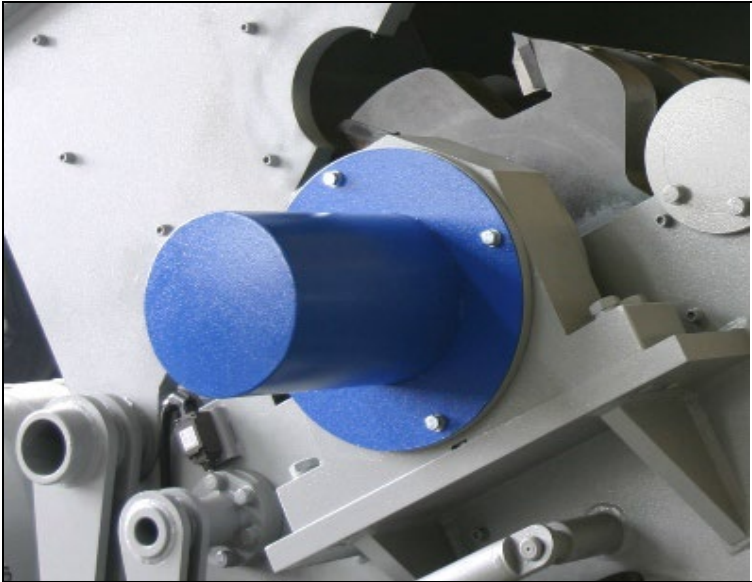

The deflection wedge, mounted in the upper section of the housing is a removable part. The deflection wedge and the block knives ensure that larger pieces of grinding material e.g. lumps, foil rolls etc. can be ground and do not cause blockage of the rotor.

Illustration:  
Deflection wedge  
(3.Stator knife)





### 5.5.2 Screen and screen support

Illustration:

- (1) Screen
- (2) Housing door
- (3) Screws for screen support
- (4) Screen support

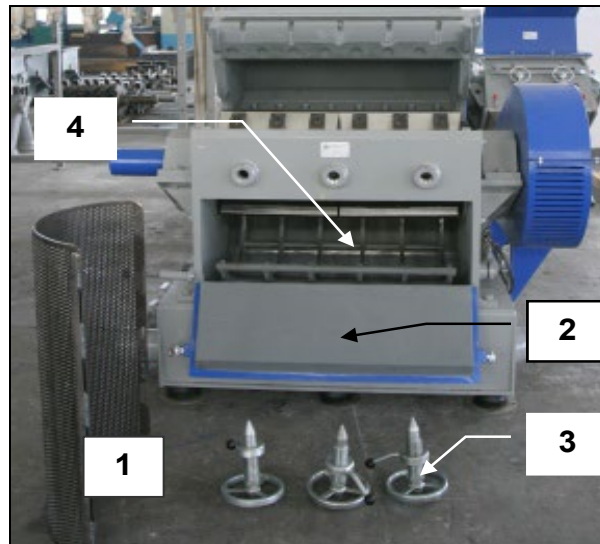

The screen lies in the supporting screen support in the granulator lower section. This screen support is arranged on bearings which can be pivoted and screwed into the working position with the granulator lower section.

Illustration:

- (1) Screen support in position "down"
- (2) Screen support in position "ready for work"
- (3) Housing door

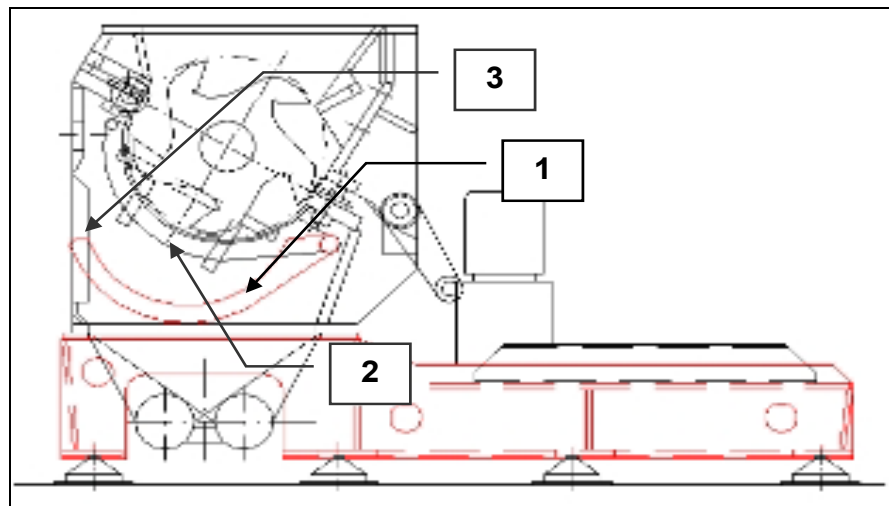

The screen is slightly larger in its radius than the cutting circle of the rotor knife. The screen perforation is selected according to the desired grain size of the grinding material. All grinding material parts which are smaller than the screen perforation fall through the screen into the suction trough. The screen is replaceable and can be taken out through the open housing flap of the granulator lower section.

## 5.6 Discharge of grinding material

Illustration:

Pipe connection for  
blower

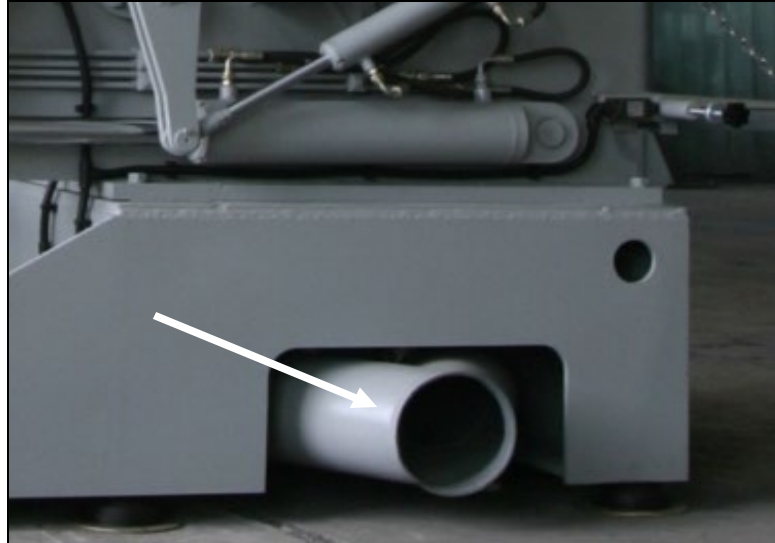

The ground material is sucked off by means of a blower out of the suction trough of the granulator. During this process, air is sucked through the in feed hopper of the granulator and drawn through the grinding chamber. At the same time, the grinding chamber and the grinding material are cooled. In addition, a partial air current is sucked in through the by-pass flap which is located on the suction trough. This air current can be regulated with the help of an air regulating flap mounted here.

Illustration:

By-pass flap

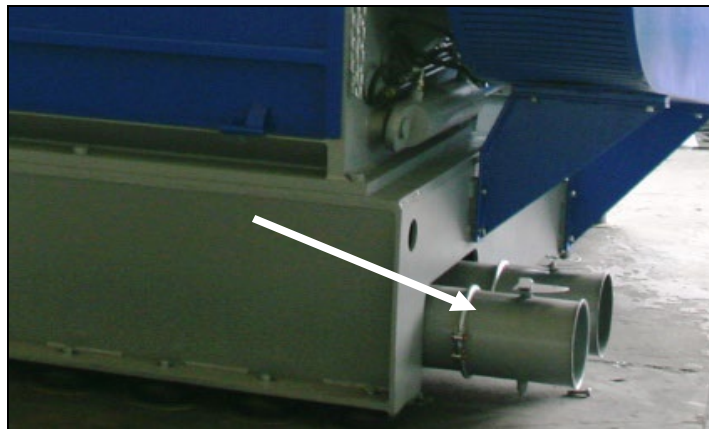

If a material blower is installed in your plant configuration, please observe the additional information for work with and on the material blower in *Part B: Accessories*.



## 5.7 Hydraulic opening device

Illustration:

- (1) Hydraulic cylinder for opening hopper and machine upper section
- (2) Hydraulic cylinder for screen support opening

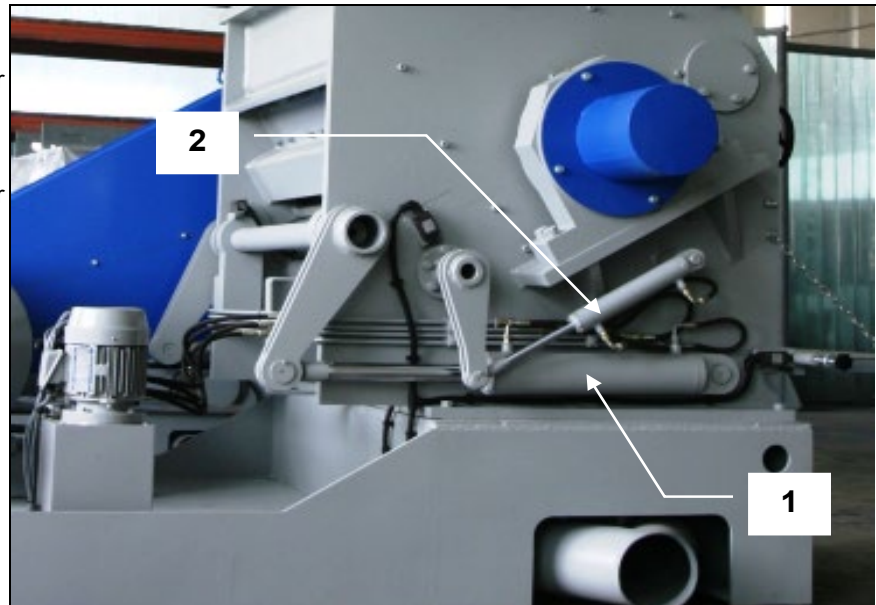

The granulator upper section and the screen support can be opened with a hydraulic system for maintenance work and cleaning. It is connected with the lower part by means of a joint.

Illustration:

- (1) Hydraulic Unit
- (2) Hydraulic Controls

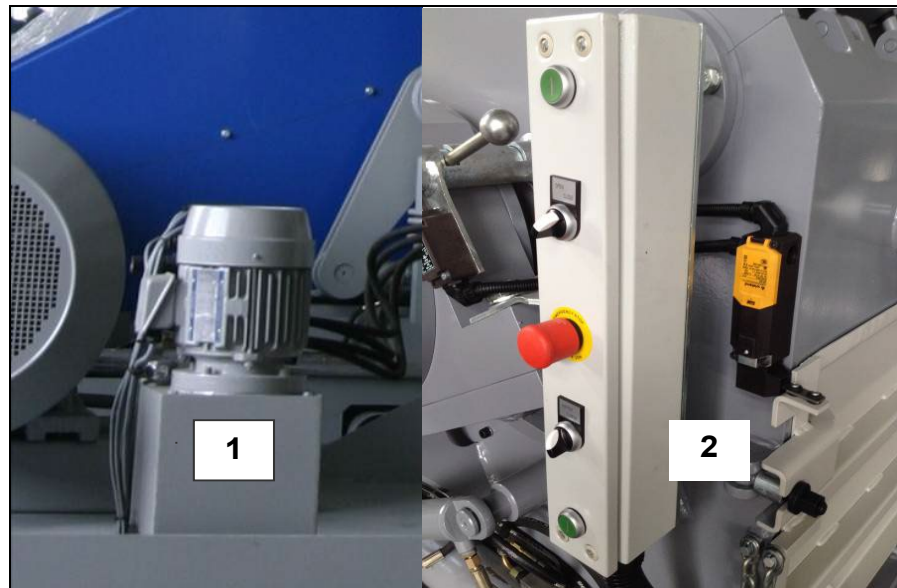

### 5.7.1 Hydraulic controls

Illustration:

- (1) Emergency STOP
- (2) Selector switch  
SCREEN/HOUSING
- (3) Selector switch  
OPEN/CLOSE
- (4) Two hand switch start  
1 and 2

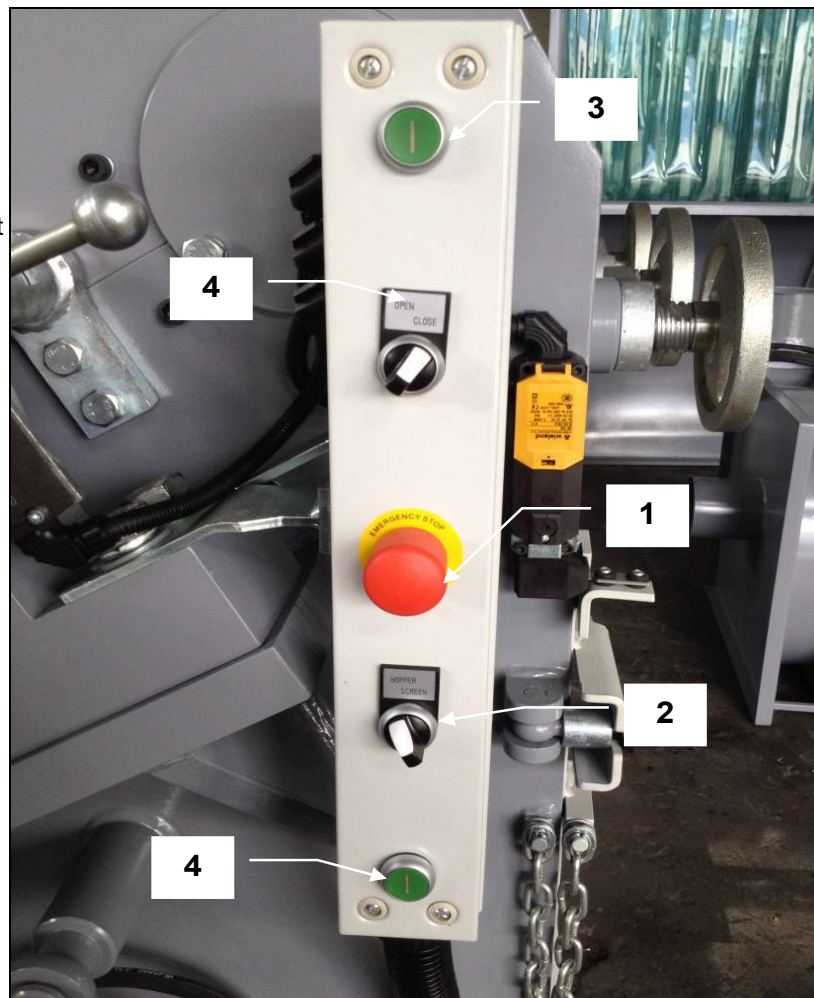

The hydraulic unit is set ready for operation at VIRTUS. Normally adjustment work is not necessary. On the control arm you have 2 buttons (Start) and 2 switches (hopper open/close and screen open/close).

## **6 INITIAL STARTUP**

### **6.1 General Advice**

**All work related to start-up may only be carried out by trained specialist personnel.**

**Check the machine for possible transportation damage or other damage. Should you determine damage, have this confirmed by the freight company and please report this to us in writing immediately after delivery. When starting up for the first time and after setting up ready for service, you must carry out the necessary checks according to the chapter *Machine Check prior to Initial Start-up*.**



### **6.2 Requirements at the application site**

The site of application for the machine must exhibit the following features:



- Enclosed space.
- The ground must exhibit sufficient load-bearing capacity (you can find the machine weight in the *Chapter Technical Data*). The unevenness of the ground surface may not exceed 5 mm.
- The machine must be freely accessible from all sides.
- There must be sufficient room available for operating and service personnel.
- Spatial requirements: see *Assembly drawing*. All hinged parts must be able to be opened completely.
- Vibration-free environment.
- The application site must be well-lit.
- The machine may not be exposed to direct radiation caused by radiators or the sun.
- Room temperature: +5° to +40°C
- Relative atmospheric humidity according to DIN 40040:  
15 to 70 % (indoor)  
By humidity levels higher than 70 %, apply anticorrosive agent to the metallic-finished machine parts. Insulation for the tropics is also necessary.
- The machine may not be operated within range of static discharges or strong magnetic fields as this could lead to faults in the machine control system.

### 6.3 Unloading and installing the machine

The machine or the machine components are packed so that they arrive with you safely. To see how the machine is packed or should be packed, please see the *Packing plan*. For unloading the packaged machine or machine components you may use a suitable crane or forklift truck.



 <b>WARNING</b>	
	<b>Suspended load.</b> <b>Falling loads can cause serious injury or death.</b> <b>Only use a crane or a forklift which is suitable for the weight and the dimensions of the load.</b>
	<b>Also use a suitable stopping means and pay attention to the gravity centre location.</b> <b>Do not step under the suspended load.</b> <b>Wear a safety helmet in addition to your basic protective gear.</b>

- ↓ After unloading, remove the packaging material and all transportation safety devices.
- ↓ In the case that the granulator and its accessory components have been delivered as individual items, mount these at the site of application using the mounting screws sent with the delivery exactly in accordance with the data given in the *Assembly drawing*. Only in this way can it be guaranteed that there are sufficient delivered piping parts, tubing and cable connections and that the linking places match.

 <b>WARNING</b>	
	<b>Overturning or falling machine.</b> <b>Serious injury or death can result.</b> <b>In the case that you wish to erect the granulator over a pit, on a frame or on a platform, you must secure the machine by putting mounting screws through the holes on the mounting pads (see <i>Assembly drawing</i>). If assembling the machine on solid ground, this safety device is not absolutely necessary.</b>



- ↓ Align the machine horizontally with the help of a suitable spirit level.  
Do not use blocks to place underneath the machine, use instead metal strips in order to prevent buckling of the base frame. Make sure that an even distribution of weight is achieved on all the points of support.

## 6.4 Electrical connection

 <b>WARNING</b>	
	<p><b>Dangerous voltage.</b> Touching live parts can lead to serious injury or death. All work which relates to the electricity of the machine may only be carried out by trained electricians. Observe the currently effective EMC regulations.</p>

Voltage, current, frequency and protection are marked on the *Type plate*. The voltage tolerance is  $\pm 10\%$ .

- ↓ For machines, which have been supplied none pre-wired by VIRTUS the electrical connection, is to be carried out in accordance with the enclosed *Wiring diagram* in the terminal box. When doing this, the regulations of the local electricity authority are to be adhered to. The cable cross section required is to be determined according to the rated capacity of the units.

 <b>WARNING</b>	
	<p><b>When operating specific equipment caution must be taken to prevent electrical shock. Installation, service, alterations and or modifications must only be done by qualified personal and with up most safety. Not conforming to the requirements could result in bodily injury, death or costly damage.</b></p>



## HINT

Alterations to the wiring diagrams from VIRTUS require our approval. Failure to do this will exclude all guarantee claims.

The wiring schematics are located in the control panel in the event that the control panel is a part of the delivery.

### **Connection of Emergency Stop button**

The machine may only be operated with installed Emergency Stop buttons. In the case that no Emergency Stop buttons have been installed at the factory, an Emergency Stop button must be installed at the control cabinet, the second at the grinding material in feed.

### **Checking the rotational direction**

Checking the rotational direction is part of the machine checks before initial start-up (see chapter of same name). The steps prior to this check must be carried out beforehand.

Switch the machine on and then immediately off again for a short time (see Switch on machine and Switch off machine).

- ↓ Observe whether the discharge air fan in the drive motor is rotating in the direction of the attached direction arrow.



## **HINT**

**If running in the wrong direction, reconnect the motor connection immediately. Damage to the machine will result from operation in the wrong direction.**



## 6.5 Machine check prior to initial start-up

Check	See chapter
1. When granulator is open, check the knife mounting screws using a torque wrench.	<i>Replacing and checking the cutting knife mountings.</i>
2. Search the grinding chamber for foreign matter.	<i>Closing the granulator</i>
3. Open the housing flap on the housing lower section and check whether the screen has been inserted in accordance with the regulations.	<i>Emptying the screen</i>
4. Close granulator upper section and fasten screws tightly.	<i>Opening and closing the granulator.</i>
5. Examine in feed device (accessories) for foreign matter.	<i>Part B: Accessories.</i>
6. Check that the <i>Emergency Stop buttons</i> are unlocked.	
7. Check all safety devices for proper functioning.	<i>Checking the protective devices.</i>
8. Switch on machine for a short time and check rotational direction. The rotational direction can be seen at the discharge air fan of the drive motor (observe running direction arrow).	<i>Electrical connection.</i>
9. Allow machine to run for approx. 10 minutes without grinding material.	<i>Switch on machine.</i>
10. Connect material blower (accessories) and in feed device (accessories), check rotational direction of blower.	<i>Part B: Accessories.</i>
11. Feed grinding material uniformly. Too much grinding material can lead to overload of the machine.	<i>Manual in feed of grinding material.</i>
12. If necessary, check the temperature of the ground material.	
13. Monitor the ammeter. This displays the present current consumption and in this way gives information on the load of the machine. The ammeter is only integrated into granulators which have been delivered with an electrical control system.	
14. Open the air regulating flap on the by-pass flap far enough so that the trough is completely emptied (do not open further!).	<i>Discharge of grinding material</i>

## 7 OPERATION

Have you read and understood the operation manual, in particular the safety advice in the chapter on? You may not operate the machine until you have done so!

### TIP



Should faults occur during work with the machine, please observe the advice in the chapter *Troubleshooting*.

### 7.1 Machine checks before switching on the machine

Check	See
1. The knives are properly set and the screws are tightened with the specified torque.	<i>Replacing and checking the cutting knife mountings.</i>
2. The screen is inserted into the screen support in accordance with the rules and the screen support is held fixedly at the end position due to the tightened mounting screws.	<i>Emptying the screen.</i>
3. The grinding chamber is free of foreign matter.	<i>Closing the granulator</i>
4. The housing flap on the screen support is closed.	<i>Emptying the screen.</i>
5. The granulator upper section is closed and screwed to the granulator lower section.	<i>Opening the granulator</i>
6. All safety devices including those of the installed grinding material in feed and discharge devices are checked and operative.	<i>Checking the protective devices.</i>
7. The material blower is installed properly and the air regulating flap on the suction trough is set so that the grinding material can be completely sucked away.	<i>Part B: Accessories.</i>

### 7.2 Switch on machine



1. Switch on the grinding material discharge device.
2. Switch on the granulator (main switch to 1). Wait until the rotor has reached its full speed and switched from star to delta.
3. Switch on the grinding material in feed device (accessories).



### **7.3 Switch off machine**

1. Switch off the grinding material in feed device (accessories).
2. Wait until the remaining grinding material has been ground, then switch off the granulator, (main switch to 0).
3. Switch off the grinding material discharge device.

### **7.4 Manual in feed of grinding material**

 <b>DANGER</b>	
	<p><b>Rotating knives. Can cause serious cutting and crushing injuries, possibly leading to death. Do not reach into the in feed hopper or lean in whilst the rotor is running (pay attention to the 3 minute run down time). Only use approved grinding material.</b></p>



- ↓ Throw the grinding material into the grinding chamber through the splash guard.

If in your design of machine an additional in feed device is installed, please observe the additional information for work with and on the in feed device *Part B: Accessories*.

## 8 MAINTENANCE

### 8.1 Safety advice

Trained specialist personnel may only carry out work included within the framework of maintenance. Carry out the maintenance work within the specified time and document this. The machine will thank you for this by providing high reliability.

 <b>WARNING</b>	
	<b>Danger caused by electrical voltage and starting the machine during maintenance work. Mortal danger.</b>
	<b>Therefore, as a basic rule when carrying out maintenance work: Main switch to 0, safeguard using padlock and attach a warning sign.</b>

### 8.2 Maintenance plan

The tasks for maintenance work are described in detail in this chapter.

<b>Maintenance work</b>	<b>Every day</b>	<b>Every week</b>	<b>Every month</b>
Check protective devices for proper functioning.		<b>x</b>	
Clean machine.		<b>x</b>	
Check cutting knife mountings.	<b>x</b>		
Check the main bearings and regrease 80g			<b>x</b>
Lubricant replacement, lubricant renewal	<b>See motor manual</b>		
Check "V"-belt tension force and "V"-belt condition.			<b>x</b>
Check condition of cutting knives.		<b>x</b>	
Check all screws of the machine for a tight fit.		<b>x</b>	
Check wearing parts. (screen, wear plates)			<b>x</b>

#### Yearly maintenance



The purpose of yearly maintenance of the machine is primarily to check the general condition of the machine and to arrange for the supply of any necessary replacement parts in good time. A service engineer from VIRTUS can also carry this out on request.

**8.3 Checking the protective devices**

For this, see also the chapter *Protective devices*.

Check the safety devices for:

- Stipulated condition,
- Stipulated location,
- Safe mounting,
- Stipulated function.

 <b>WARNING</b>	
	<p><b>Danger due to non-functioning protective devices. Serious injury or death can result.</b></p> <ul style="list-style-type: none"><li>• <b>Eliminate all defects before you put the machine into operation!</b></li><li>• <b>If defects occur during operation, stop the machine immediately and eliminate the defects!</b></li><li>• <b>Do not change or remove any protective devices. Do not put any protective devices out of action by modifying them.</b></li></ul>

## 8.4 Opening and closing the granulator

For some maintenance work it is necessary to open the granulator.

<b>! WARNING</b>	
	<p><b>Granulator upper section pivots downwards. Serious injury can result. Always open the granulator upper section completely. Intermediate positions are not allowed. Make sure when closing that no persons are in the danger area.</b></p>

### 8.4.1 Opening the granulator upper section

**Proceed as follows:**

- ↓ Switch off the granulator at the main switch
- ↓ Activate the key switch “DOOR OPEN”
- ↓ Activate the hydraulic via key switch on the control panel
- ↓ Rotate out the threaded spindle by hand and open the soundproof housing
- ↓ Open the bolts, which are connecting the lower with the upper section of the granulator.



- ↓ Open the hopper by using the hydraulic system, by pushing the start buttons of the 2 hand switch on the control arm. ( Selector switch 1 at HOPPER and selector switch 2 at OPEN)



---

**8.4.2 Closing the granulator**

**Proceed as follows:**



- ↓ Clean all surfaces between the granulator upper section and the granulator lower section with a hand brush as well as all contact surfaces on the screen.
- ↓ Check that there are no objects in the grinding chamber.
- ↓ Close the hopper slowly to ensure that all parts fit properly, by pushing the start buttons of the 2 hand switch on the control arm. (Selector switch 1 at HOPPER and selector switch 2 at CLOSE)
- ↓ Tighten the connecting bolts between the granulator lower section and the granulator upper section.
- ↓ Switch of the hydraulic via key switch on the control panel
- ↓ Deactivate the key switch "DOOR OPEN"
- ↓ Machine can be started again.

## 8.5 Cleaning the machine

 <b>WARNING</b>	
	<p><b>Danger of cutting caused by sharp cutting knives, even when the rotor is at a standstill.</b> <b>Serious injury, particularly to hands and fingers, can result.</b> <b>Wear protective gloves.</b></p>

**Proceed as follows:**

- ↓ Open granulator (see *Opening the granulator* ).
- ↓ Remove the screen.
- ↓ Empty the screen.

 <b>WARNING</b>	
	<p><b>Inhalation of grinding dust which is dangerous to the health.</b> <b>This can result in injury to the respiratory tract.</b> <b>Never blow out the grinding material residue, use suction instead.</b> <b>Wear breathing protection if necessary.</b></p>

- ↓ Pre-clean the grinding chamber using a hand brush.
- ↓ Suck up the remaining grinding material residue using a suitable suction device.
- ↓ Remove clinging grinding material residue using a suitable wooden scraper.
- ↓ Put the screen into the screen support.
- ↓ Pivot the screen support into the working position using the hydraulic system and fasten with the mounting screws
- ↓ Close the granulator upper section (see *Closing the granulator*).
- ↓ Rotate in the threaded spindle completely
- ↓ Machine can be started again

## **8.6 Replacing the main bearings**

The main bearings of the machine are dimensioned so that a bearing replacement is only necessary in exceptional cases. Dismounting and mounting of the bearings requires specialist knowledge and a careful working method. Therefore, in addition to the following advice, please observe the instructions given in the installation manual of the bearing manufacturer.

The bearings mounted in this machine are indicated in the spare parts list. A requirement for dismounting and mounting the bearings is a suitable pulling-off device.

### **8.6.1 Dismounting the main bearings**

#### **To dismount the bearings proceed as follows:**

The parts which are marked with a piece number are illustrated in the drawings of the spare parts list!

- ↓ Dismount the "V"-belt cover.
- ↓ Dismount the "V"-belts (see *Replacing the screen*).
- ↓ Loosen the tensioning element for the "V"-belt pulley (see, *Mounting and dismounting TAPER-LOCK tensioning element*).
- ↓ Pull the "V"-belt pulley off the rotor axis, do not tip up. Use suitable lifting and stopping means.
- ↓ Pull the distance sleeve off the rotor axis.
- ↓ If the granulator is equipped with a disk fly wheel, dismount this in the same way as the "V"-belt pulley.
- ↓ Open the granulator upper section (see *Opening the granulator*).
- ↓ Dismount the cutting knives (see *Dismounting the cutting knives*).
- ↓ Unscrew the bearing housing from the granulator lower section.
- ↓ Carefully lift out the complete rotor using suitable lifting and stopping means.
- ↓ Lay the rotor down in a safe location. Suitable for this are timber beams of appropriate size.
- ↓ Loose the bearings cover mounting screws and take off the bearing cover.
- ↓ Pull the bearing housing off with a pulling-off device.
- ↓ Pull the bearing off the rotor axis using a pulling-off device.

## 8.6.2 Mounting the main bearing

### To mount the bearings proceed as follows:

- ↓ Before mounting, clean the bearing surfaces and the shaft surfaces thoroughly and grease lightly.
- ↓ Mount bearing in bearing housing.
- ↓ Attach the bearing with the bearing housing to the rotor axis.

## HINT



- During mounting, the mounting forces must always engage into the inner ring, otherwise the roller bodies will be damaged.
  - The hardened bearing rings are sensitive to impact stress. For this reason, never hit directly on the rings with the hammer, use instead preferably a brass arbor or better still a striking bush (piping piece) made from a soft material. The inner diameter of the striking bush should be only slightly larger than the diameter of the bearing base.
  - The bearing is then pushed onto the shaft using light blows. When doing this, the force of pressure must be evenly distributed on the circumference of the bearing ring.
  - If the plummer block is also replaced, the rotor must be readjusted to the centre of the granulator.
- 
- ↓ Lift the rotor using suitable lifting and stopping equipment and put carefully into the receptacle of the granulator lower section.
  - ↓ Attach the bearing housing (Pos. ) to the granulator lower section using screws.
  - ↓ Mount the cutting knives.
  - ↓ Close the granulator upper section (see Closing the granulator).
  - ↓ If the granulator is equipped with a disk flywheel:
    - ↓ Push the disk flywheel onto the rotor axis and tighten using the tensioning element.
    - ↓ Push the distance sleeve (Pos. ) onto the rotor axis.
  - ↓ Mount the "V"-belt pulley and tighten using the tensioning element. (see, *Mounting and dismounting TAPER-LOCK tensioning element*).
  - ↓ Pull on "V"-belts and adjust the "V"-belt tension force ( see Retensioning and relaxing the "V"-belt).
  - ↓ Attach the "V"-belt cover.
  - ↓ Carry out a test run.



## 8.7 Lubricating the main bearings

An important requirement for high operational safety and long service life of the arrangement of bearings is the correct lubricant supply. Every VIRTUS machine is greased and checked in test runs before delivery.

### HINT



**Unsuitable lubricant, lubricant deficiency, excessive lubrication or impurities in the lubricant lead to overheating and thus extreme wear of the bearings.**

#### 8.7.1 Lubrication intervals:

Shift operation	Replace lubricant	Check
One shift operation:	every 18 months	monthly
Two shift operation:	every 9 months	monthly
Three shift operation:	every 6 months	monthly

#### 8.7.2 Check lubricant quality

You can judge whether the lubricant needs to be replaced by checking for the following features:

- change in consistency,
- discolouration,
- degree of soiling.

#### 8.7.3 Replacing or refilling lubricant

### HINT



- Fill the bearings uniformly with grease, so that all operating surfaces are well greased.
- For the rotor bearings, a lubricant quantity of one third to a maximum of half of the bearing volume per bearing is required. If too much grease is filled in, the lubricant will become unusable as a result of excessive temperature.
- Only one type of grease may be used, mixing different types of grease is not allowed. The bearings have been filled at the factory with lithium base saponification roller bearing grease F3.
- To find out which lubricants from which manufacturers you can use, look in the *List of lubricants*.

### **Refilling lubricant**

The grease reaches through the circulating grooves and bores via lubrication nipples into the interior of the bearing.  
The greasing quantity is 60 to 100 g roller bearing grease F3 per bearing.

Illustration:  
Grease nipple

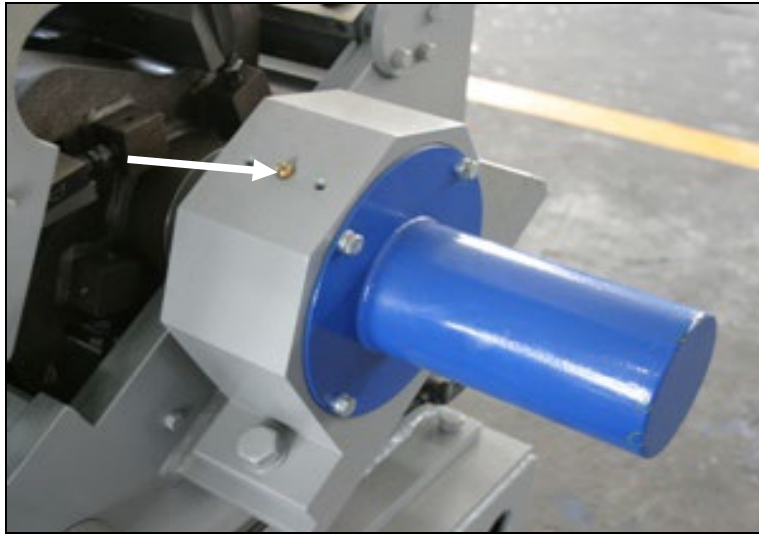

### **Replacing lubricant**

Only in the case of unusual bearing noises or overheating is it also necessary to renew the lubricant between the specified intervals. Mounting and dismounting of the bearings is to be carried out in accordance with the instructions in this operation manual (see *Replacing the main bearing*).

- ↓ Open the bearing.
- ↓ Remove the bearing casing and the bearing cover.
- ↓ Clean the bearing carefully using petroleum ether.  
Petroleum ether, petroleum, spirit, aqueous neutral or alkaline cleaning agents may be used to clean the bearings. After washing out, the bearing must immediately be preserved using lubricant, in order to avoid corrosion.
- ↓ Fill bearing with approved lubricant (see *List of lubricants*).

**8.7.4 List of lubricants**

<b>Country of manufacture / manufacturer</b>	<b>Roller bearing grease</b>
ARAL	ARAL Grease HL 3
BP	BP ENERGREASE LS 3
CASTROL	CASTROL SPHEEROL AP 3
ESSO	Beacon 3
FUCHS	FUCHS Grease 1200 FUCHS Grease FWA 220
SHELL	SHELL Alvania Grease 3
MOBIL-OIL	MOBILUX 3
WISURA	WISURA Liba L 3
Zeller & Gmelin	ZET GE Grease M 50
FAG	FAG L 71
ANTAR Petroles de l'Antlantique	ROLEXA
Holland, Beverol	Beverol Multi Purpose Grease
Italy, Agip	AGIP Grease 33 FD
Swede, NYNÄS	Nynäs FI 3-42

## **8.8 Mounting and dismounting the DOKO tensioning element**

### **8.8.1 Installation and operation**

The rotor-"V"-belt pulley and the disk fly wheel (accessories) are mounted to the shaft or axis by means of DOKO tensioning elements. The disks must be dismantled for certain maintenance work.

Illustration:

Tensioning element

- (1) Hub body
- (2) Tensioning bush
- (3) Tensioning screws



The hub body and the tensioning element have a joint stepped cone. The tensioning element has a slit and contains corresponding holes to put the tensioning screws through. Arranged offset between these are threaded holes which serve to receive the tensioning screws functioning as threaded screws. The hub body has corresponding threaded holes in the area of the inner relief for receiving the tensioning screws. The length of the thread allows maximum utilization of the tensioning screws.

**Tightening torque of the screws: 395Nm**

### 8.8.2 Mounting the DOKO tensioning element

**Proceed as follows:**

- ↓ Make sure the cylindrical bore of the tensioning element and the appropriate cylindrical part of the shaft as well as the conical surface of the tensioning element are free from oil, grease or other protective coatings.
- ↓ Rub the conical surfaces and the screws in the threaded portion and under the head with Molycote paste „G“ or colloidal graphite.
- ↓ Put the tensioning element into the hub body and safeguard against it falling out using the mounting screws.
- ↓ Put two screws loosely into the opposing threaded bores.
- ↓ Push the hub body onto the shaft and tighten the screws evenly. Your attention is drawn to the fact that when tightening the screws the outer portion pulls on the inner bush, i.e. here the axially occurring shift measure should be observed for the end position of the body. This measure lies between approx. 1-6 mm depending on the size of the bush. This is dependent on the clearance present between the shaft and the bore of the inner bush and between the diameter of the outer sleeve and the work piece bore as well as the necessary clamping force of the screws.
  
- ↓ If, when fastening the hub onto the shaft, the position of the disk is not yet exactly correct, loosen the screws slightly and tighten the screws lightly which are inserted in the threaded bores. In this way, the tensioning element will become loose again in the hub and the disk can be pushed onto the shaft by hand.
- ↓ Having exactly aligned the threaded screws, screw again into their own threaded bore.
- ↓ Tighten the opposing screws evenly in several steps using a torque wrench. The values can be found in the table.

If the tensioning elements only have to be dismantled for the first time after a longer period, you should spray corrosion solvent into the slit and into the open screw holes and allow this to react for a sufficient amount of time.

---

### **8.8.3 Dismounting the DOKO tensioning element**

**Proceed as follows:**

- ↓ Loosen the screws and screw into the threaded bores.
- ↓ Tighten the threaded screws evenly using a torque wrench set to the permissible torque (see table for the values) and push out the tensioning element.
- ↓ If the tensioning element cannot be loosened using the threaded screws, hit uniformly with a plastic hammer on the edge of the hub.
- ↓ Then try to loosen the tensioning element by tightening the threaded screws again using the torque wrench. Keep repeating this process until the tensioning element becomes loose.
- ↓ Remove the tensioning element.

## 8.9 Mounting and dismounting TAPER-LOCK tensioning element

The motor-"V"-belt pulley is attached onto the shaft by means of a TAPER-LOCK tensioning element. The disks must be dismantled for certain maintenance work.

**IMPORTANT:** Follow all instructions in this manual carefully. This is necessary to insure satisfactory performance.

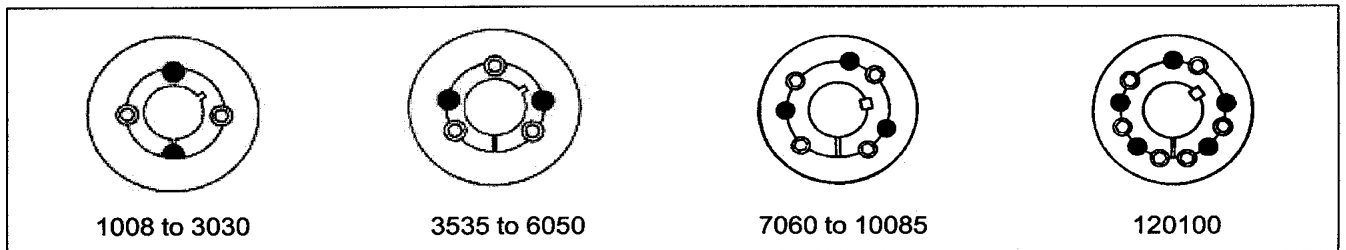

### To Install:

1. Clean shaft, bore, and outside of bushing, and bore of hub (taking bushing from hub if already assembled). Remove any oil, lacquer, or dirt. Place bushing in hub and match half holes to make complete holes (each complete hole will be threaded on one side only).
2. Oil thread and point of set screws or thread and under head of cap screws. Place screws loosely in holes that are threaded on hub side (shown thus  in diagram).
3. Make sure bushing is free in hub. Slip assembly onto shaft and locate in position desired.
4. Tighten screws (see note\*) alternately and evenly until all are pulled up very tightly. Use a piece of pipe on wrench to increase leverage. (See table for wrench torque on reverse side.)
5. Hammer against large end of bushing using hammer and block or sleeve to avoid damage. Screws can now be turned a little more using the specified wrench torque. Repeat this alternate hammering and screw re-tightening until the specified wrench torque no longer turns the screws after hammering.
6. After drive has been running under load for a short time stop and check tightness of screws. Fill other holes with grease to exclude dirt.

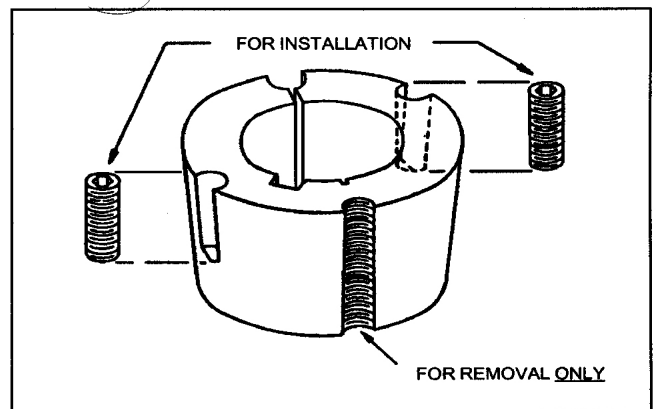

### To Remove:

1. Remove all screws. Oil thread and point of set screws or thread and under head of cap screws.
2. Insert screws in holds that are threaded on bushing side (shown thus  in diagram). In sizes where washers are found under screw heads, be sure to use these washers. Note that one screw in each hub is left over and is not used in this loosening operation.
3. Tighten screws alternately until bushing is loosened in hub. If bushing does not loosen immediately, tap on hub.

### 8.9.1 Table for the tightening torque of the screws

Tensioning element (Type)	Screws-Tightening torque in Nm	Screw details	
		Number	Size (BSW)
3535	60	3	1/2"
4040	102	3	5/8"

### **8.9.2 Mounting the TAPER-LOCK tensioning element**

**Proceed as follows:**

- ↓ Remove the protective coating from the bore and outside of bush, and bore of hub. After ensuring that the mating tapered surfaces are completely clean and free from oil or dirt. Insert bush in hub so that holes line up.
- ↓ Sparingly oil thread and point of grub screws, or thread and under head on cap screws. Place screws loosely in holes threaded in hub, shown thus ☉ in.
- ↓ Clean shaft and fit hub to shaft as one unit and locate in position desired, remembering that bush will hip the shaft first and then will be slightly drawn on the bush.
- ↓ Using a hexagon wrench tighten screws gradually and alternately to certain torque.
- ↓ Hammer against large-end of bush, using a block or sleeve to prevent damage. (This will ensure that the bush is seated squarely in the bore). Screws will now turn a little more. Repeat this alternate hammering and screw tightening once or twice to achieve maximum grip on the shaft.
- ↓ If a key is to be fitted place it in the shaft keyway before fitting the bush. It is essential that it is a parallel key and side fitting only and has TOP CLEARANCE.
- ↓ After drive has been running under load for a short time stop and check tightness of screws.
- ↓ Fill empty holes with grease to exclude dirt.

### **8.9.3 Dismounting the TAPER-LOCK tensioning element**

**Proceed as follows:**

- ↓ Slacken all screws by several turns, remove one or two according to number of jacking off holes shown thus • in the illustration. Insert screws in jacking off holes after oiling thread and point of grub screws or thread and under head of cap screws.
- ↓ Tighten screws alternately until bush is loosened in hub and assembly is free on the shaft.
- ↓ Remove assembly from shaft.



## 8.10 Replacing the screen

In order to keep the throughput of the granulator and the quality of the grinding material constant, the condition of the screen must be checked regularly.

The screen may be damaged, dirty or not suitable for the grinding material:

- Screen holes too fine: overheating of the grinding material.
- Screen holes too course: parts in ground material which are too big.

### **Proceed as follows:**

- ↓ Switch off the granulator at the main switch, safeguard main switch using a padlock.
- ↓ Switch off the granulator at the main switch
- ↓ Activate the key switch "DOOR OPEN"
- ↓ Open the housing flap.
- ↓ Unfasten the screen support mounting screws.



- ↓ Pivot the screen support downwards, by pushing the start buttons of the 2 hand switch on the control arm. ( Selector switch 1 at SCREEN and selector switch 2 at OPEN)

Illustration:

Tensioning element

- (1) Screen
- (2) Screen support
- (3) Screen support spindles

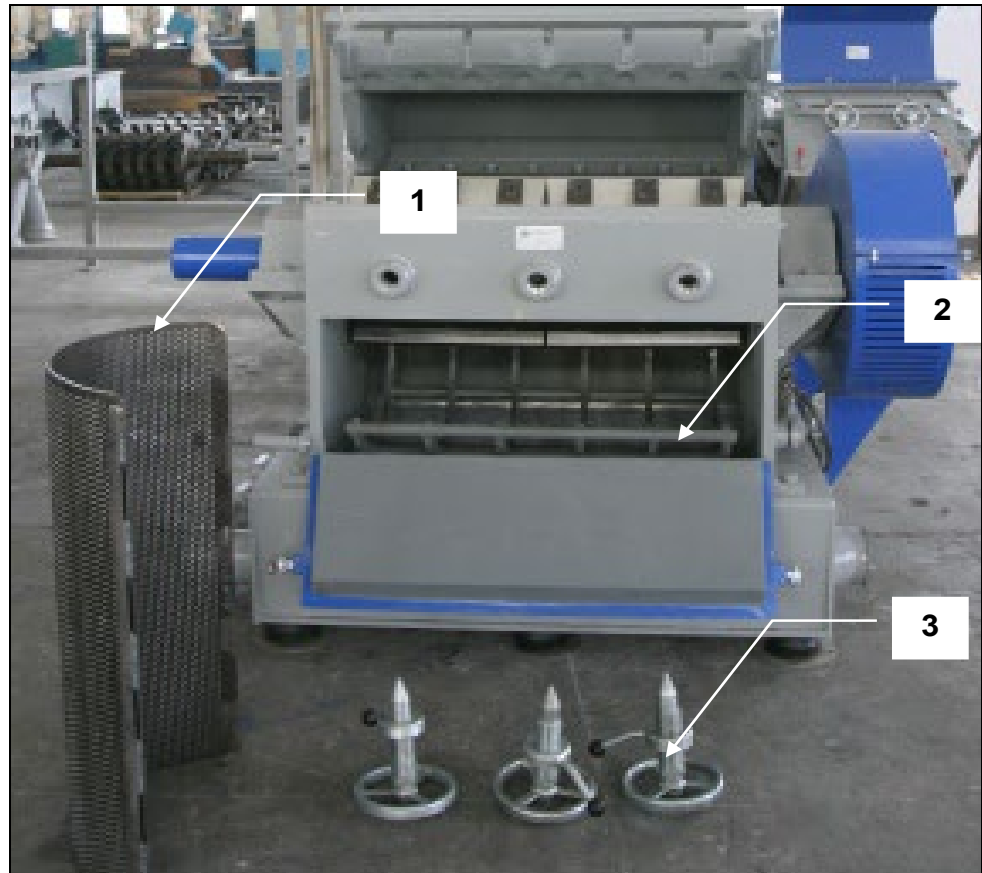

- ↓ Remove the screen.
- ↓ Put a new screen into the screen support.
- ↓ Pivot the screen support into the working position, by pushing the start buttons of the 2 hand switch on the control arm. ( Selector switch 1 at SCREEN and selector switch 2 at CLOSE)
- ↓ Fasten the screen support by using the mounting screws.
- ↓ Close the housing flap.
- ↓ Deactivate the key switch "DOOR OPEN"
- ↓ Granulator can be started again.

## 8.11 Work on the "V"-belts

"V"-belts are wearing parts, which stretch and must be retensioned. In order to guarantee a long service life of the "V"-belts, regular checks on the tension force of the "V"-belts and the condition of the "V"-belts are necessary.

### 8.11.1 Checking the tension force of the "V"-belt

Illustration:

- a: Distance between roller centres
- b: Sag
- F: Force(direction)

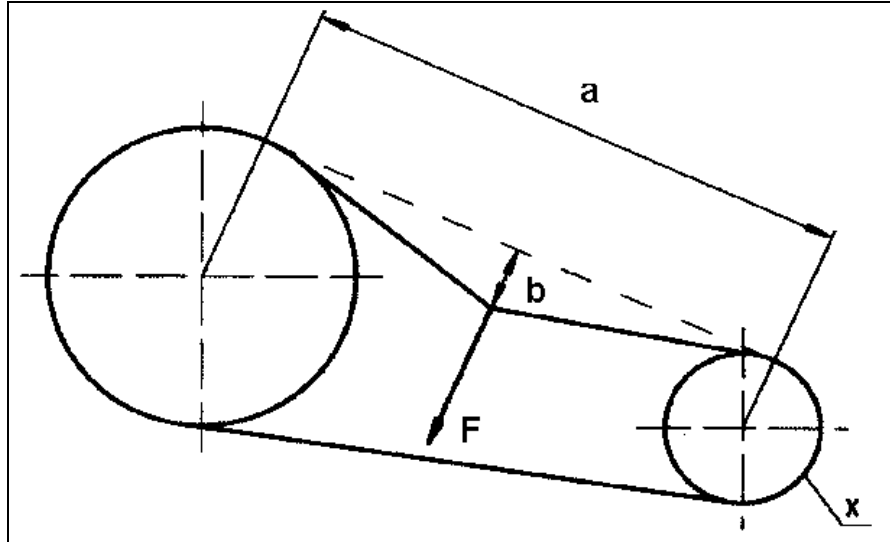

- ↓ Remove the "V"-belt cover.
- ↓ Measure the distance between the roller centres.
- ↓ Determine the belt sag force F for each belt at 16 mm sag if sag "b" is equal to 1 m distance between roller centres. Do this by measuring at the middle of the distance between roller centres at a right angle to the "V"-belt.

		Force required for 1 m distance between roller centres and 16 mm sag	
Profile section	Efficiency of x in mm	P in Newton	P in lbs
SPC	224 - 355	60 - 90	13,2 - 19,8
SPC	375 - 560	90 - 120	19,8 - 26,4

- ↓ Compare determined value with the value in the above table. If the value lies below the lowest tolerance limit, the "V"-belt must be retensioned. If the value lies above the highest tolerance limit, the "V"-belt must be relaxed.



### 8.11.2 Retensioning and relaxing the "V"-belt

Enlarging or decreasing the centre distance "A" into which the drive motor is shifted carries out tensioning or relaxing the "V" - belt.

**Proceed as follows:**

- ↓ Loosen the tensioning screw.
- ↓ Shift the drive motor as required onto the sliding rails.
- ↓ Lock the drive motor into new position using both tensioning screws in such a way that the motor shaft is parallel to the rotor axis and aligned.
- ↓ Check the tension force of the "V"-belt (see *Checking the tension force of the "V"-belt*).
- ↓ Mount the "V"-belt cover.

### 8.11.3 Checking "V"-belt condition, replacing "V"-belt

 <b>CAUTION</b>	
	<p><b>Danger of pulling into machine caused by running "V"-belts.</b> <b>Hair, jewellery etc. can be pulled into the machine. Serious injury can result.</b> <b>Never dismantle the "V"-belt cover and window during operation.</b></p>

- If a "V"-belt is porous or ripped, it must be replaced as follows:
- ↓ Remove the "V"-belt cover.
  - ↓ Loosen the front and rear tensioning screw.
  - ↓ Relax the "V"-belt by shifting the drive motor.
  - ↓ Put new "V"-belt in.
  - ↓ Tension the "V"-belt (see Retensioning and relaxing the "V"-belt).
  - ↓ Mount the "V"-belt cover.

## **8.12 Working on the cutting knives**

In the case of granulators, the correct grinding properties, correct setting and mounting of the cutting knives are important factors to ensure perfect functioning and economic operation of the machine.

### **8.12.1 Replacing and checking the cutting knife mountings**

Due to their function, certain machine parts are subject to stress in their operating state as a result of vibrations, which can lead to loosening of the screw connections. Therefore, it is absolutely necessary to check the cutting knife mounting screws in accordance with the *Maintenance plan*.

- ↓ Tighten the mounting screws on the cutting knives using a torque wrench which is set to the required torque for the screw size.  
**The required torque for the knife fixing bolts is 580 Nm.**

You can find out the required torque from the following table. Take note too that the tightening capacity decreases of screws which have been loosened and tightened again several times. New screws of the same material quality must therefore replace the cutting knife mounting screws after they have been loosened and tightened several times.

#### **Torque:**

Bolt type	Grade 8.8		Grade 10.9		Grade 12.9	
	Nm	lbf ft	Nm	lbf ft	Nm	lbf ft
M8	25	18.4	35	25.8	41	30.2
M10	49	36.1	69	50.9	83	61.2
M12	86	63.4	120	88.5	145	106
M16	210	154	295	217	355	261
M20	410	302	580	428	690	508
M24	710	523	1000	737	1200	885

### 8.12.2 Checking the condition of the cutting knives

<b>! WARNING</b>	
	<b>Danger of cutting caused by sharp knives, even when the rotor is at a standstill. Serious injury, particularly to hands and fingers, can result. Wear protective gloves.</b>

The cutting knives become blunt after a certain number of operation hours. Therefore they should be checked regularly.

**Using blunt knives has the following consequences:**

- Decreased grinding capacity.
- Increased current consumption of the drive motor.
- Inexact cut.
- Overheating of the ground material.

### 8.12.3 Dismounting the cutting knives

<b>! WARNING</b>	
	<b>Danger of cutting caused by sharp knives, even when the rotor is at a standstill. Serious injury, particularly to hands and fingers, can result. Wear protective gloves.</b>

**Proceed as follows:**

Illustration:

- (1) Rotor knife
- (2) Knife mounting screws

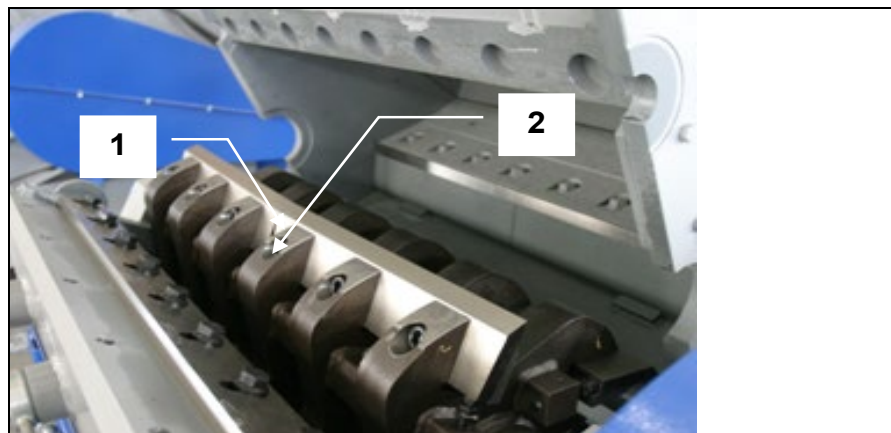

- ↓ Open the granulator (see *Opening the granulator* ).
- ↓ Safeguard the rotor against torsion.
- ↓ Loosen the knife mounting screws.
- ↓ Take out the knife capping and knives.

#### 8.12.4 Mounting the cutting knives

### **WARNING**



**Danger of cutting caused by sharp knives, even when the rotor is at a standstill.  
Serious injury, particularly to hands and fingers, can result.  
Wear protective gloves.**

### **HINT**



**The cutting knives, in particular the rotor knives, should only be sharpened or replaced in sets. There is a danger of balance error if a combination of rotor knives from different knife sets is used.**

#### **Proceed as follows:**

- ↓ Clean the knife supporting surface and threaded holes.
- ↓ Insert sharp and preset knives and push against the setting surface.
- ↓ Put on the knife capping.
- ↓ Screw in the mounting screws and tighten using a torque wrench.

**The required torque for all knife mounting bolts is 580 Nm (also see the table under *Replacing and checking the cutting knife mountings*).**

- ↓ **Check whether the cutting gap is correct and whether the cutting knives do not collide as the rotor turns.**

### **TIP**



**Stator knives from VIRTUS have two symmetrical cutting edges.**

**This makes it possible to turn the knives and only to sharpen after every second knife change.**

- ↓ Remove tools and other objects from the grinding chamber.
- ↓ Close the granulator upper section (see *Closing the granulator*).
- ↓ Switch on the granulator for a short time without grinding material and listen for noises. If you hear unusual noises, determine the cause and eliminate it.

8.12.5 Sharpening cutting knives

## TIP



Specialist sharpening of the cutting knives is part of the service offer of VIRTUS.

## WARNING



Danger of cutting caused by sharp knives, even when the rotor is at a standstill. Serious injury, particularly to hands and fingers, can result. Wear protective gloves.

## HINT



The cutting knives, in particular the rotor knives, should only be sharpened or replaced in sets. There is a danger of balance error if a combination of rotor knives from different knife sets is used.

### Proceed as follows:

- ↓ Dismount the cutting knives (see *Dismounting the cutting knives*).
- ↓ Sharpen the cutting knives.  
A specialist in accordance with the sharpening plan using particular care should uniformly sharpen the cutting knives mechanically. It is important to make sure that sharpening takes place with small grinding allowance and sufficient coolant supply. The sharpening process is finished when the cutting edge is sharply cut. Not all indentations must be ground out; otherwise the number of possibilities for sharpening is unnecessarily reduced. For the sharpening process, use soft grinding wheels (Quality 40 H or 46 K). Knives, which have grinding cracks, are not to be reused due to danger of breakage during operation.
- ↓ Whet the cutting edges of the cutting knives using a whetstone.  
By taking these measures, the service life of the cutting knives can be increased.
- ↓ Set the cutting knives (see *mounting the cutting knives*).
- ↓ Mount the cutting knives (see *mounting the cutting knives*).



Illustration: *Resharpener plan S-rotor knife*

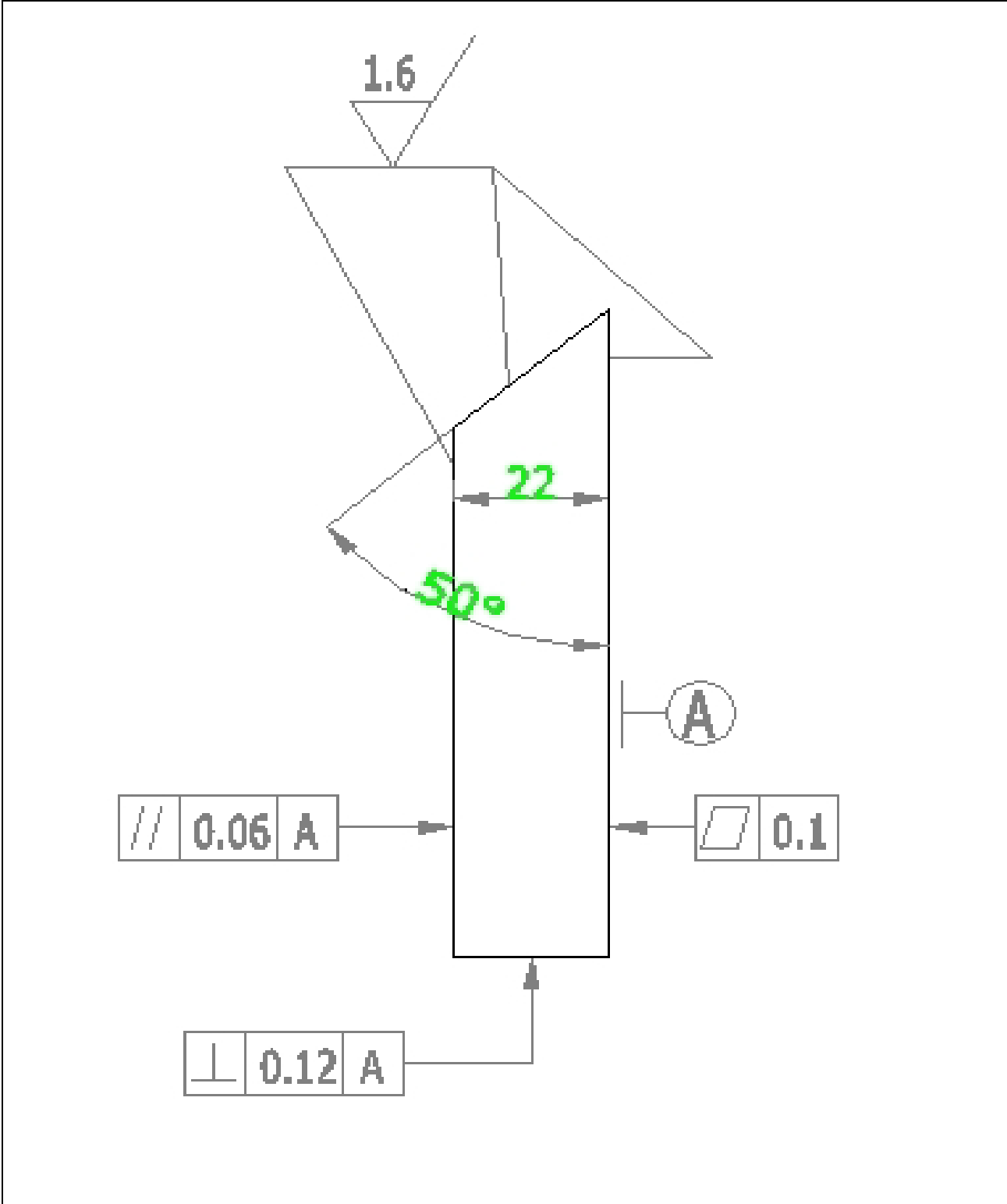

Illustration: *Resharpener plan stator knife*

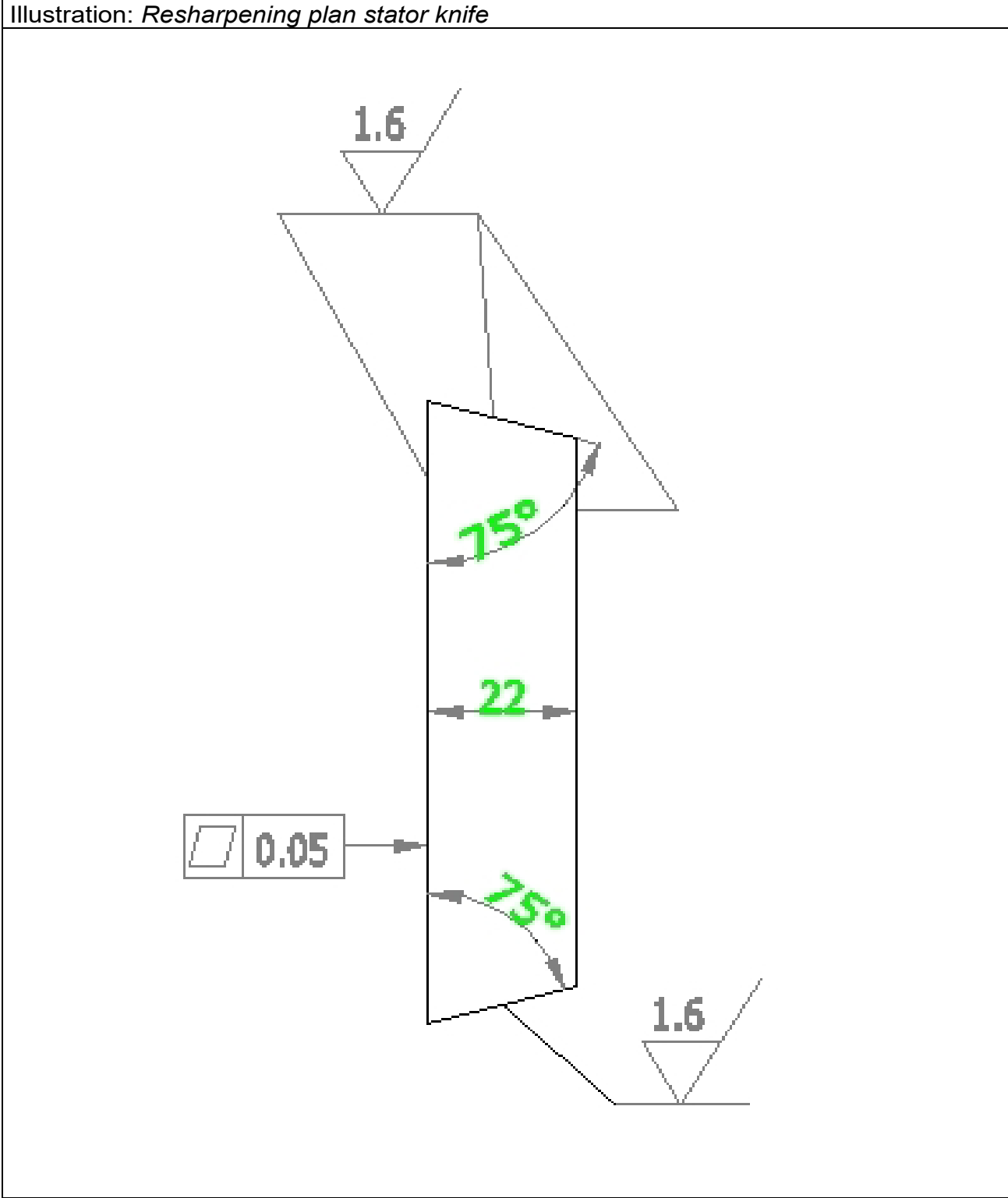
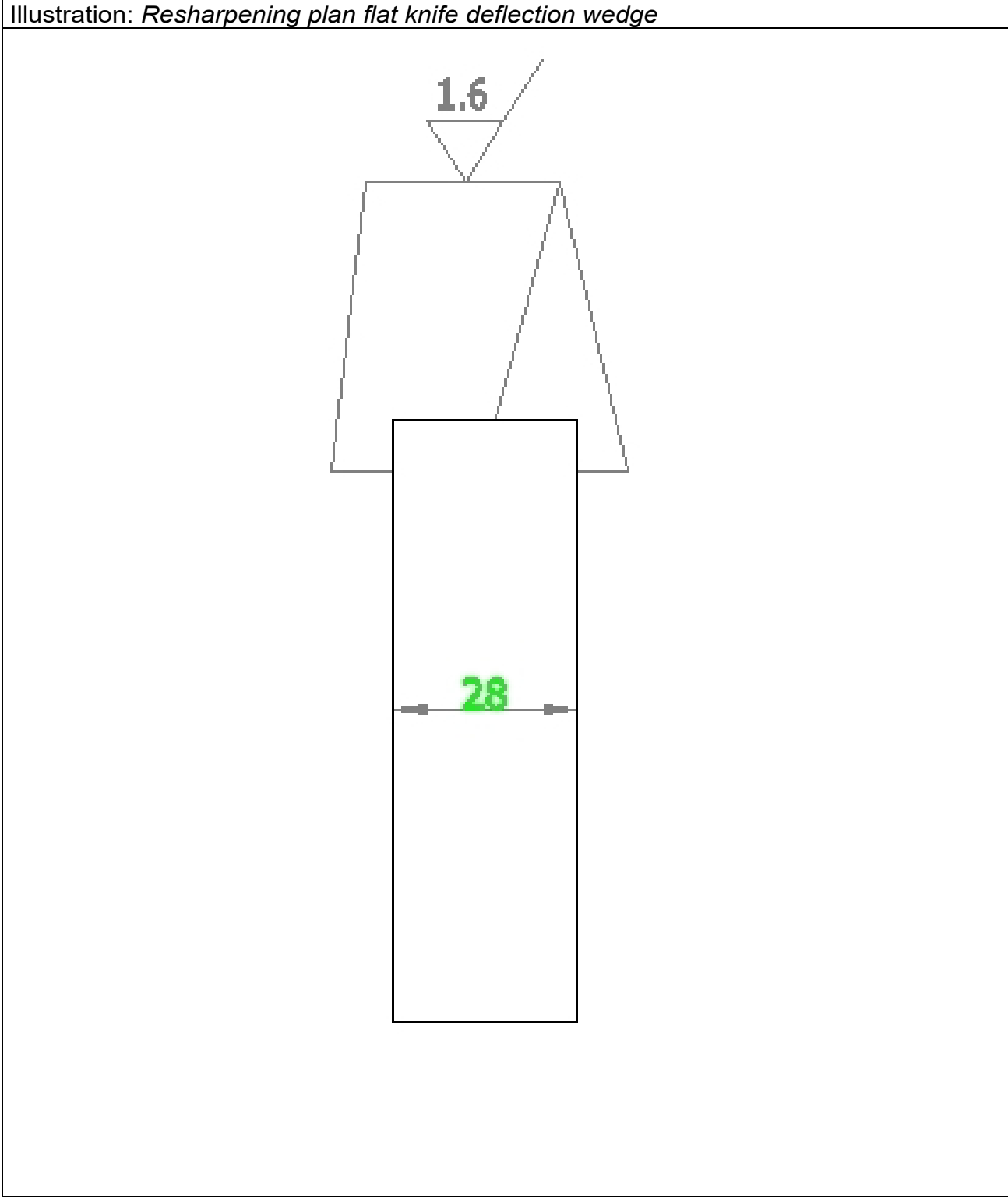



Illustration: *Resharpener plan flat knife deflection wedge*



**8.12.6 Setting the cutting knives**

<b>⚠ WARNING</b>	
	<p><b>Danger of cutting caused by sharp cutting knives. Serious injury, in particular to hands and fingers, can result. Wear protective gloves.</b></p>

To simplify knife setting and shorten standstill periods when replacing the knives, a knife setting device is delivered together with rotors with adjustable knives.

Knife setting can be carried out easily outside the machine using this setting device. If you have several knife sets, you will also avoid standstill periods of the machine.

Correct and careful setting of the gap between the rotor knives and the bed knives (cutting gap) is an important requirement for the productive capacity of the granulator.

Factors for the size of the knife gap are the size of the rotor, the design of the rotor and the material to be ground.

The cutting gap is set using the knife gap of the rotor knives in the knife-setting device.

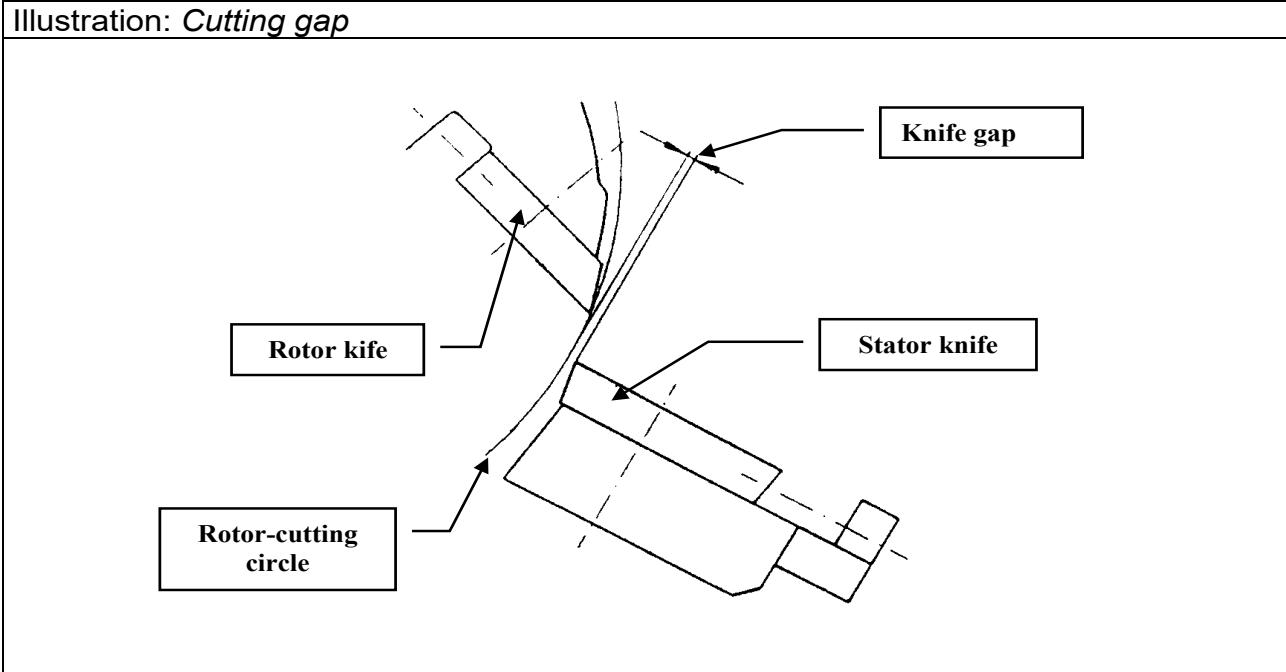

**For setting the rotor knives, proceed as follows:**

Illustration:

Knife setting device

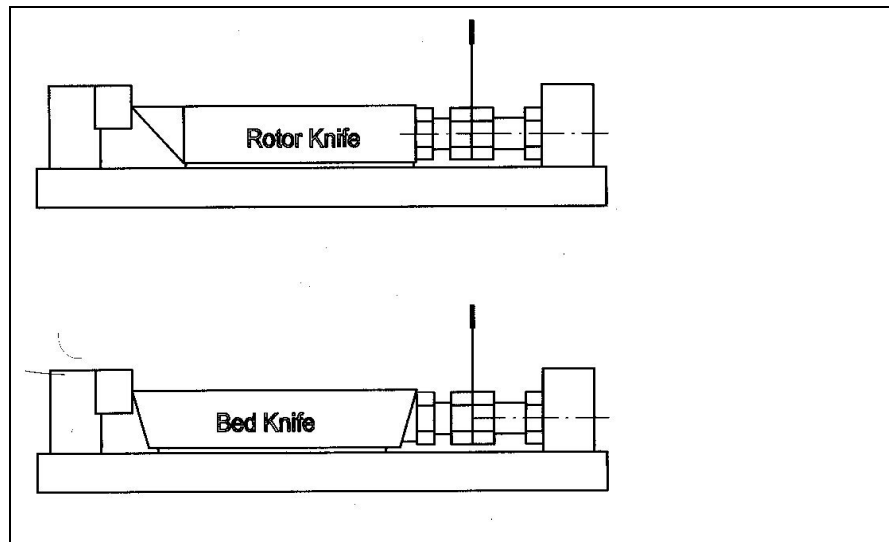
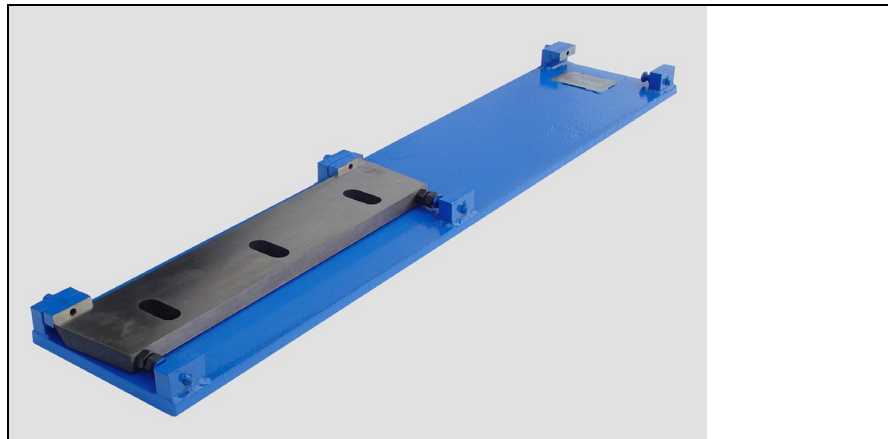

- ↓ Insert the knives into the knife setting device as shown.
- ↓ Select the guide calibre appropriate for the size of the knife gap from the delivered guide calibre set.  
The guide calibres are marked with numbers, which when divided by 100, give the thickness in mm.

**Further procedure for each setting screw:**

- ↓ Push the guide calibre between the stopper of the knife setting device and the setting screw of the cutting knife.  
Doing this, the knife edge must lie against the stopper.
- ↓ Unscrew the setting screw of the knife so far that the feeler gage is gently squeezed.
- ↓ Tighten the counter nut.
- ↓ Set all the setting screws as described.  
Check the knife gap at the end of setting and correct if required.

**Recommended knife gap: 0,3mm**

Illustration:

- (1) Rotor knife
- (2) Knife fixing bolt
- (3) Cover plate

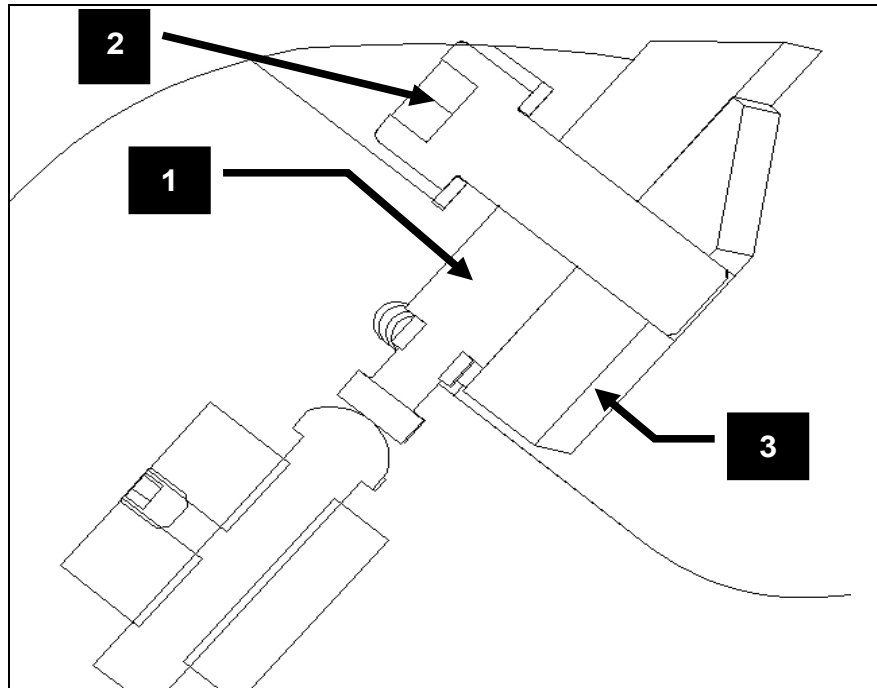

## HINT

In operating state, the granulator heats up and expands unevenly. Therefore, if the knife gap is too small this can lead to machine damage caused by the knives colliding.

Illustration: *Cutting gap*

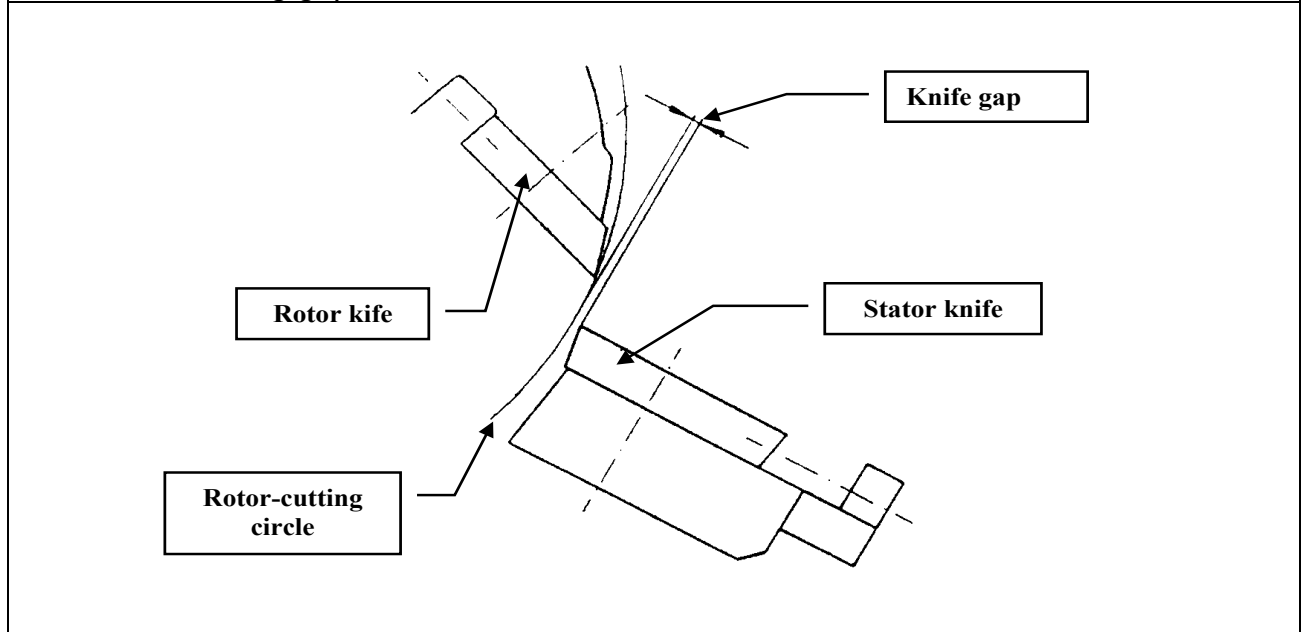

### 8.12.7 Transporting and storing the cutting knives



#### **WARNING**



**Danger of cutting caused by sharp cutting knives. Serious injury, in particular to hands and fingers, can result. Only transport and store the cutting knives packaged. Grease the cutting knives well, so that they do not rust. Protect the cutting edges with doubled cardboard and use adhesive tape to safeguard the knives against slipping out of the sides of the sheath.**

**After unpacking, you must degrease the cutting knives so that they can be gripped safely.**

## 8.13 Deflection wedge removal

 <b>WARNING</b>	
	<b>Danger of cutting caused by sharp knives. Serious injury, particularly to hands and fingers, can result. Wear protective gloves.</b>

The deflection wedge and the block knives ensure that larger pieces of grinding material e.g. lumps, foil rolls etc. can be ground and do not cause blockage of the rotor.

Illustration:  
Deflection wedge





The deflection wedge, mounted in the upper section of the housing is a removable part.

For bulky items like drums, barrels or blow moulding parts the deflection wedge can be removed as follows:

- ↓ Switch off the granulator at the main switch
- ↓ Safeguard main switch using a padlock.
- ↓ Remove the hopper from the machine housing
- ↓ Screw Eye bolts in the deflection wedge
- ↓ Fix lifting equipment so that the wedge cannot fall down after removing the fixing bolts
- ↓ Remove the fixing bolts from the deflection wedge on the backside of the upper machine section
- ↓ Take out the deflection wedge



 <b>WARNING</b>	
	<b>Ensure that the deflection wedge cannot fall onto the rotor shaft while removing the fixing bolts.</b>

For operation without the deflection wedge place the cover plate into the unit and screw in bolts from the rear.  
The cover plate prevents both damage to the rear surface of the housing and material leaving the granulator through bolt holes. The cover plate is only supplied with the unit if the granulator is intended for operation without the deflection wedge.

## 9 TROUBLESHOOTING

### 9.1 Machine blocks or switches itself off

No.	Possible causes	Remedy required
9.1.1	Too much feed material.	Reduce grinding material in feed.
9.1.2	Screen blocked.	Clean screen, check condition, if necessary select larger screen perforation.
9.1.3	"V"-belts slip.	Check "V"-belt tension and condition and retighten if necessary or replace.
9.1.4	Knife condition.	Check knives and resharpen or replace if needed.
9.1.5	Cutting gap.	Check cutting gap and set according to the instructions in this operation manual.
9.1.6	Suction trough blocked.	Change in rotational direction of blower needed. Replace fan blades if necessary. Open the air regulating flap on the suction trough as far as necessary. Check discharge air flow from cyclone for blockages.
9.1.7	Current failure.	Check limit switch for defective contact. Check electrical connection, if necessary tighten limit switch.
9.1.8	Fuse too small.	Fit larger fuse. <b>Only after consulting the service department of VIRTUS.</b>
9.1.9	Frequent peak loads.	Install disk flywheel.
9.1.10	Rotational direction of rotor.	Check motor and reverse polarity if necessary.
9.1.11	Rotor speed.	Change rotor speed. <b>Only after consulting the service department of VIRTUS.</b>
9.1.12	Bed knives mounted mirror inverted.	Knife tip must protrude in direction of rotation.

### 9.2 Rotor does not grip bulky material

No.	Possible causes	Remedy required
9.2.1	Knife condition.	Check and sharpen if needed according to the instructions in this operation manual.
9.2.2	Protruding bed knife.	Chamfer bed knives, consult with service department of VIRTUS .

### 9.3 Overheating of the grinding material

No.	Possible causes	Remedy required
9.3.1	See 9.1.1 to 9.1.5. See 9.1.11 and 9.1.12.	See 9.1.1 to 9.1.5. See 9.1.11 and 9.1.12.
9.3.2	Screen perforation too small.	Insert a screen with larger perforation.
9.3.3	Knives wrongly sharpened.	Modify knife finish. <b>Only after consulting the service department of VIRTUS.</b>
9.3.4	Suction air.	Close air-regulating flap on suction trough step by step.
9.3.5	Material rubs against the housing wall.	Fit anti-winding device.
9.3.6	Insufficient cooling.	Fit water-spraying device, increase air intake (larger suction fan).
9.3.7	Suction fan rotates in wrong direction.	Check connection, if required reverse polarity.

## 9.4 Unusual vibrations

No.	Possible causes	Remedy required
9.4.1	Rotor out of balance.	Weigh knives, balance rotor.
9.4.2	Bearing damage.	Check bearings, replace bearings if necessary.
9.4.3	Mounting pads defective (vibration elements).	Check mounting pads and renew these if necessary.

## 9.5 Extreme cutter wear

No.	Possible causes	Remedy required
9.5.1	Bearing damage.	Check bearings, replace bearings if necessary.
9.5.2	Knife finish.	Check knife and sharpen or replace if necessary.
9.5.3	Wrong cutting angle.	Modify cutting angle after consulting VIRTUS service department.
9.5.4	Wrong cutting angle.	Check cutting gap and set according to the instructions in this operation manual.
9.5.5	Foreign matter.	Fit feed device with a metal detector.

## 9.6 Bearings too hot

No.	Possible causes	Remedy required
9.6.1	Too much grease in bearing.	Reduce amount of grease.
9.6.2	"V"-belts too tight.	Reduce tension.
9.6.3	Rubbing on housing sealing ring.	Check sealing ring, oil or replace.
9.6.4	Bearing damage.	Check bearings, replace if necessary.
9.6.5	No grease in bearing.	Lubricate bearing.

## 9.7 Too many fines in grinding material

No.	Possible causes	Remedy required
9.7.1	Type of material.	Fit fines separator under cyclone.
9.7.2	Screen worn.	Renew screen, possibly using manganese steel.
9.7.3	Unsuitable screen perforation.	Replace screen after consulting VIRTUS service department.
9.7.4	Suction unit too weak.	Change rotor speed. <b>Only after consulting the service department of VIRTUS.</b>

## 9.8 Cutting gap alters during operation

No.	Possible causes	Remedy required
9.8.1	Knife mounting screws not tight.	Retighten using torque wrench in accordance with table in operation manual.
9.8.2	Screw fatigue.	Fit new screws.
9.8.3	Cover disks or plate deformed.	Insert new cover disks or plate.
9.8.4	Supporting surfaces not clean.	Clean and de-rust supporting surfaces.
9.8.5	Threads in housing worn.	Fit new bushes in housing.

## 9.9 Screen damage

No.	Possible causes	Remedy required
9.9.1	Screen inserted wrongly.	Fit screen correctly.
9.9.2	Screen support buckled.	Replace screen support.

## 9.10 Granulator does not start

No.	Possible causes	Remedy required
9.10.1	Limit switches not activated.	Check position of limit switch and correct.
9.10.2	Main and control fuses.	Replace fuse.
9.10.3	Feed device not connected.	Switch on in sequence.
9.10.4	Residue material in granulator.	Empty granulator before switching on.
9.10.5	Star delta connection.	Correct wiring on motor.
9.10.6	Motor protection switches off.	Check motor relay for correct setting and increase if necessary.
9.10.7	Star delta time relay.	Correct time.

## 9.11 Granulator blocks when under load

No.	Possible causes	Remedy required
9.11.1	Feed starts too early.	Start feed only after switch over from star to delta.
9.11.2	Limit switch loose or wrongly set.	Reposition and tighten limit switch.
9.11.3	Fuse defective.	Replace fuse. Fit larger fuse. <b>Only after consulting the service department of VIRTUS.</b>
9.11.4	Motor fuse switches off - red indicator.	Reduce feed quantity of the grinding material, correct setting, replace fuse.

## 9.12 Frequent switching off of grinding material in feed device

No.	Possible causes	Remedy required
9.12.1	Current relay switches off.	Correct setting.

## 10 STORAGE, DISPOSAL, TRANSPORTATION

### 10.1 Storage



Clean the machine (see *Closing the granulator*). Preserve all polished metal surfaces using a suitable rust preventing agent. Store the machine in an enclosed, dry place. Cover the machine completely with a plastic sheet.



### 10.2 Disposal



**Protect the environment.**

The disposal of machines, machine components and process materials is partially subject to legal controls. More detailed information is given at the relevant administrative authority (e.g. regional and national Water Conservation Bureaux and Environmental Protection Agencies). Only deposit the material to be disposed of at authorized drop-off points.

### 10.3 Transportation

 <b>WARNING</b>	
	<p><b>Suspended load.</b>  <b>Falling loads can cause serious injury or death.</b>  <b>Only use a crane or forklift truck, which is suitable for the weight and dimensions of the loads.</b></p>
	<p><b>Also use suitable stopping means and pay attention to the gravity centre location.</b>  <b>Do not step under the suspended load.</b>  <b>Wear a protective helmet in addition to your basic protective gear.</b></p>

## 11 HYDRAULIC MAINTENANCE

Before start-up of the machine, hydraulic oil has to be filled into the tank.

The type of oil which should be used depends on your location. We recommend oil of the type DIN 51524 HLP 32 for areas with temperatures below 0°C in the winter and HLP 46 for temperatures of around 30°C in the summer. For extremely hot tropical areas e. g. Thailand, Malaysia, Nigeria etc. we recommend to use HLP 68.

The first oil replacement should be done after one year and than every year one time. The oil filter has to be replaced too.



### HINT

**If the oil will not be replaced after this time damage to the hydraulic system can occur, due to overheating of the oil and dirt in the oil. This can lead to a complete standstill of the machine.**

When adding hydraulic oil, attention must be paid that the same type of oil is used. If the same type of oil is not available, or if the type used is unknown, the oil in the tank and in the complete hydraulic system has to be removed and the complete system flushed carefully. The system may only be filled with new oil after this has been done. This is necessary to prevent gumming of the valves.

**Hydraulic liquid recommendation:**

Designation to DIN 51 524	HLP 32
Ambient temperature:	-7 to +70°C
Supplier	Name of the oil
ARAL	Aral Vitam GF 32 Aral Vitam HF 32
BP	BP Energol HLP-D 32 BP Energol HLP 32 BP Energol SHF 32
ELF	Elfolna 32 Hydrelf 32
ESSO	Nuto H 32 HLPD-Oel 32
FINA	Fina Hydran 32
FUCHS	Renolin MR 10 Renolin B 10
MOBIL	Mobil DTE 24 Mobil DTE 17 Drucköl HLP 32 - C Hydrauliköl HLPD 32
TEXACO	Rando Oil HD A - 32 Rando Oil HD AZ - 32 Alcor Oil DD 32

## 12 CUSTOMER SERVICE AND SPARE PARTS ORDERS



Should problems occur during operation of the machine or if you have general questions about the machine which this operation manual cannot answer, please do not hesitate to contact us. We would be pleased to help you further in order to solve your problem as quickly as possible.

You can identify the spare parts you require using the spare parts list. Please quote the following information when making your order so that we can deliver the spare parts to you quickly:

- Company name and address.
- Contact person.
- Machine type.
- Machine number.
- Piece number of the spare part.
- Spare part reference.
- Subject number.
- Order quantity.

Virtus Equipment  
9120 Centerlinks Commerce DR., Unit 4  
Fort Myers, FL 33912

Phone: +1-239-219-1500

E-Mail: [PARTS@VIRTUS-EQUIPMENT.com](mailto:PARTS@VIRTUS-EQUIPMENT.com)

Internet: [www.VIRTUS-Equipment.com](http://www.VIRTUS-Equipment.com)



### TIP

The easiest way to order your spare parts is to copy the spare parts list and to fill in the order amount after the respective spare part.



## 13 SPARE PARTS LIST

### 13.1 H 60/80

Pos.	Pc	Description/Standard	Partnumber/SAP	Order
100		<b>Machine complete</b>	10000240	
101	1	Standard hopper	20000000	
102	1	PVC-curtain 1	80012240	
103	1	Cover plate	80008430	
104	1	PVC-curtain 1	80012240	
105	1	Cover plate	80008430	
106	1	PP-curtain	80012220	
107	1	Shaft	80008990	
108	1	Housing upper section	20002500	
109	2	Wearing plate upper section	20004200	
110	1	Housing lower section	20004600	
111	2	Wearing plate lower section	20006300	
112	1	Door	20008200	
113	1	Threaded spindle	20013000	
114	1	Base frame	20014900	
115	1	Suction trough	20018950	
116	10	Anti vibration pad	80012740	
117	5	Connecting bolts upper section-lower section DIN 444 M20x135 8.8	80010310	
200		<b>Screen complete</b>		
201	1	Screen support	20006400	
202	2	Screen support spindle	20006700	
203	1	Screen adjusting bolt	20007700	
204	1	Screen		
300	2	<b>Bearing</b>		
301	2	Bearing housing SN324	20031800	
302	2	Bearing 22324/W33	80002980	
303	1	Bearing Cover A	20011700	
304	2	Bearing Cover B	20011800	
305	1	Bearing Cover C	20012000	
306	4	Sealing	80004040	
307	2	Key	80003430	
308	24	DIN 912 M10x30 8.8		
309	2	Grease nipple		
400		<b>Drive</b>		
401	1	Motor 55 kW	80000080	

**PART A: Basic machine  
Granulator  
H 60/80-70/100**

		Motor 75 kW	80000050 80000052 80020060	
		Motor 90 kW	80000030	
402	1	Rotor pulley SPC 800-6	80001950	
403	1	Rotor pulley taper bush TB 5050-120	80002220	
404	1	Key	80003430	
405	5	V-Belt SPC 4000	80002570	
406	1	Motor pulley SPC 280-6	80001990	
407	1	Motor pulley taper bush TB 3535-65	80002340	
		Motor pulley taper bush TB 3535-75	80002330	
408	1	Pulley cover	20017400	
409	1	Shaft cover	20012600	
410	2	Sleeve 1		
411	1	Sleeve 2		
412	2	Washer		
413	2	DIN127-20		
414	2	DIN933/M20x60/8.8		
500		<b>5-knife rotor</b>		
501	10	Rotor knife 385x100x22	80000920	
502	30	Fixing Bolt M20x60/DIN 912/12.9	80011352	
503	30	Washer	80010780	
504	20	Adjusting bolt M12x40/flat head/12.9	20031600	
505	20	Nut M12/DIN 934/12.9	80010470	
506	20	Adjusting bolt M16x70/ball head/12.9	20031500	
507	10	Cover plate ( Rotor knife )	80001500	
508	20	Set screw DIN914/M10x12	80011710	
500		<b>7-knife rotor</b>		
501	14	Rotor knife 385x100x22	80000920	
502	42	Fixing Bolt M20x60/DIN 912/12.9	80011352	
503	42	Washer	80010780	
504	28	Adjusting bolt M12x40/flat head/12.9	20031600	
505	28	Nut M12/DIN 934/12.9	80010470	
506	28	Adjusting bolt M16x60/ball head/12.9	20031500	
507	14	Cover plate ( Rotor knife )	80001500	
500		<b>A4- rotor</b>		
501	16	Rotor knife 192x100x35	80050662	
502	48	Fixing Bolt DIN7984 - M20x55 - 12.9		
503	48	Washer DIN433 – 20		
600		<b>Stator knife</b>		
601	2	Stator knife 795x100x22	80001070	
602		Fixing Bolt M20x65/DIN 933/12.9	80010160	

**PART A: Basic machine  
Granulator  
H 60/80-70/100**

603		Washer	80010780	
604	4	Adjusting bolt M12x40/flat head/12.9	20031600	
605	4	Nut M12/DIN 934/12.9	80010470	
606	4	Wedge Washer	80012950	
607	4	Adjusting bolt M10x40/ball head/12.9	20031400	
608	1	Cover plate	20013600	
609	4	Set screw DIN914/M10x12	80011710	
700		<b>Deflection wedge</b>	20013700	
701	2	Block knife 392x100x28	80001340	
702	8	Fixing bolt ( Block knife ) M20x70 / DIN933 / 12.9	80010180	
703	8	Washer	80010780	
704	2	Adjusting bolt DIN 933 M16x45 10.9	20031700	
705	2	Nut DIN 936 M16/10	80040045	
706	2	Adjusting bolt M20x65	20014100	
707	2	Nut DIN 934 M20	80010490	
708	2	Cover plate	20110900	
709	14	Fixing bolt ( Deflection wedge ) M16x60 / DIN 912 / 12.9	80011310	
800		<b>Hydraulic</b>		
801	1	Cylinder hopper opening	80001800	
802	1	Cylinder screen opening	80001860	
803		Piping	80001600 80001610 80001640 80001650	
804		Connectors	80001700 80001710	
805	1	Hydraulic unit		
		1.5KW/400V-50HZ/220V	80001900	
		1.5KW/400V-50HZ/110V	80050102	
		1.5KW/460V-60HZ/110V	80001886	
		1.5KW/415V-50HZ/110V	80050316	
		1.5KW/415V-50HZ/220V	80050149	
900		<b>Electrical parts</b>	10002240	
901	2	Safety switch ZS336	80005600	
902	1	Control panel		

**PART A: Basic machine  
Granulator  
H 60/80-70/100**

**13.2 H 70/100**

Pos.	Pc	Description/Standard	Partnumber/SAP	Order
100		<b>Machine complete</b>	10000250	
101	1	Standard hopper	20100000	
102	1	PVC-curtain 1	80012240	
103	1	Cover plate	80008430	
104	1	PVC-curtain 2	80012240	
105	1	Cover plate	80008430	
106	1	PP-curtain	80012220	
107	1	Shaft	80009010	
108	1	Housing upper section	20102100	
109	2	Wearing plate upper section	20103600	
110	1	Housing lower section	20104100	
111	2	Wearing plate lower section	20105600	
112	1	Door	20106900	
113	1	Threaded spindle	20007800	
114	1	Base frame	20111400	
115	1	Suction trough	20114400	
116	13	Anti vibration pad	80012740	
117	5	Connecting bolts upper section-lower section DIN 444 M20x135 8.8	80010310	
200		<b>Screen complete</b>		
201	1	Screen support	20105700	
202	3	Screen support spindle	20105900	
203	2	Screen adjusting bolt	20106600	
204	1	Screen		
		φ 4	20117800	
		φ 5	20117900	
		φ 6	20124400	
		φ 8	20117700	
		φ 10	20118000	
		φ 12	20118200	
		φ 15	20123700	
		φ 16	20124800	
		φ 20	20123900	
		φ 30	20124700	
300	2	<b>Bearing</b>		
301	2	Bearing housing SN324	20031800	
302	2	Bearing 22324/W33	80002980	
303	1	Bearing Cover A	20011700	
304	2	Bearing Cover B	20011800	

**PART A: Basic machine  
Granulator  
H 60/80-70/100**

305	1	Bearing Cover C	20012000	
306	4	Sealing	80004040	
307	2	Key	80040342	
308	24	DIN 912 M10x30 8.8		
309	2	Grease nipple		
400		<b>Drive</b>		
401	1	Motor 75 kW 400V50HZ	80000050	
		Motor 90 kW 400V50HZ	80000030	
		Motor110kW 400V50HZ	80000020	
402	1	Rotor pulley SPC 900-8	80001940	
403	1	Rotor pulley bush	80002541	
404	8	V-Belt SPC 4750	80002560	
405	1	Motor pulley SPC 250-8	80001920	
406	1	Motor pulley taper bush 4040-75	80002300	
		Motor pulley taper bush 4040-80	80002290	
407	1	Pulley cover	20112600	
408	1	Shaft cover	20109400	
409	1	Sleeve 1	20109200	
410	1	Sleeve 2	20109250	
411	1	Sleeve 3	20109300	
412	2	Washer		
413	2	DIN127-20		
414	2	DIN933/M20x60/8.8		
500	1	<b>3-knife rotor</b>	20108900	
501	6	Rotor knife 485x100x22	80000910	
502	18	Fixing Bolt M20x65/DIN 933/12.9	80010160	
503	18	Washer	80010781	
504	12	Adjusting bolt M12x40/flat head/10.9	20031600	
505	12	Nut M12/DIN 934/10	80010470	
506	12	Adjusting bolt M16x70/ball head/10.9	20031500	
507	6	Cover plate ( Rotor knife )		
508	12	Set screw DIN914/M10x12	80011710	
500	1	<b>5-knife rotor</b>	20108900	
501	10	Rotor knife 485x100x22	80000910	
502	30	Fixing Bolt M20x65/DIN 933/12.9	80010160	
503	30	Washer	80010781	
504	20	Adjusting bolt M12x40/flat head/10.9	20031600	
505	20	Nut M12/DIN 934/10	80010470	
506	20	Adjusting bolt M16x70/ball head/10.9	20031500	
507	5	Cover plate ( Rotor knife ) R	80001530	
	5	Cover plate ( Rotor knife ) L	80001520	
508	20	Set screw DIN914/M10x12	80011710	

**PART A: Basic machine**  
**Granulator**  
**H 60/80-70/100**



500	1	<b>7-knife rotor</b>	20108400	
501	14	Rotor knife 485x100x22	80000910	
502	42	Fixing Bolt M20x65/DIN 933/12.9	80010160	
503	42	Washer	80010781	
504	28	Adjusting bolt M12x40/flat head/10.9	20031600	
505	28	Nut M12/DIN 934/10	80010470	
506	28	Adjusting bolt M16x70/ball head/10.9	20031500	
507	7	Cover plate ( Rotor knife ) R	80001530	
	7	Cover plate ( Rotor knife ) L	80001520	
508	28	Set screw DIN914/M10x12	80011710	
500	1	<b>9-knife rotor</b>	20107600	
501	18	Rotor knife 485x100x22	80000910	
502	54	Fixing Bolt M20x65/DIN 933/12.9	80010160	
503	54	Washer	80010781	
504	36	Adjusting bolt M12x40/flat head/10.9	20031600	
505	36	Nut M12/DIN 934/10	80010470	
506	36	Adjusting bolt M16x70/ball head/10.9	20031500	
507	9	Cover plate ( Rotor knife ) R	80001530	
	9	Cover plate ( Rotor knife ) L	80001520	
508	36	Set screw DIN914/M10x12	80011710	
600		<b>Stator knife</b>		
601	2	Stator knife 995x100x22	80001060	
602	16	Fixing Bolt M20x65/DIN 933/12.9	80010160	
603	16	Washer	80010780	
604	4	Adjusting bolt M12x40/flat head/10.9	20031600	
605	4	Nut M12/DIN 934/10	80010470	
606	4	Wedge Washer	80012950	
607	4	Adjusting bolt M10x40/ball head/10.9	20031400	
608	1	Cover plate	20110000	
609	4	Set screw DIN914/M10x12	80011710	
700	1	<b>Deflection wedge</b>	20110200	
701	2	Block knife 490x100x28	80001330	
702	8	Fixing bolt ( Block knife ) M20x70 / DIN933 / 12.9	80010180	
703	8	Washer	80010780	
704	2	Adjusting bolt DIN 933 M16x45 10.9	20031700	
705	2	Nut DIN 936 M16/10	80040045	
706	2	Adjusting bolt M20x65	20014100	
707	2	Nut DIN 934 M20	80010490	
708	2	Cover plate	20110900	
709	14	Fixing bolt ( Deflection wedge ) M16x60 / DIN 912 / 12.9	80011310	

**PART A: Basic machine  
Granulator  
H 60/80-70/100**



800		<b>Hydraulic</b>		
801	2	Cylinder hopper opening	80001780	
802	2	Cylinder screen opening	80001840	
803	6	Piping 1	80001640	
	6	Piping 2	80001650	
804	10	Connector	80001700	
805	1	Hydraulic unit		
		1.5KW/400V-50HZ/220V	80001900	
		1.5KW/400V-50HZ/110V	80050102	
		1.5KW/460V-60HZ/110V	80001886	
		1.5KW/415V-50HZ/110V	80050316	
		1.5KW/415V-50HZ/220V	80050149	
900		<b>Electrical parts</b>		
901	3	Safety switch ZS336	80005600	
902	1	Control panel		

**13.3 Machine complete**

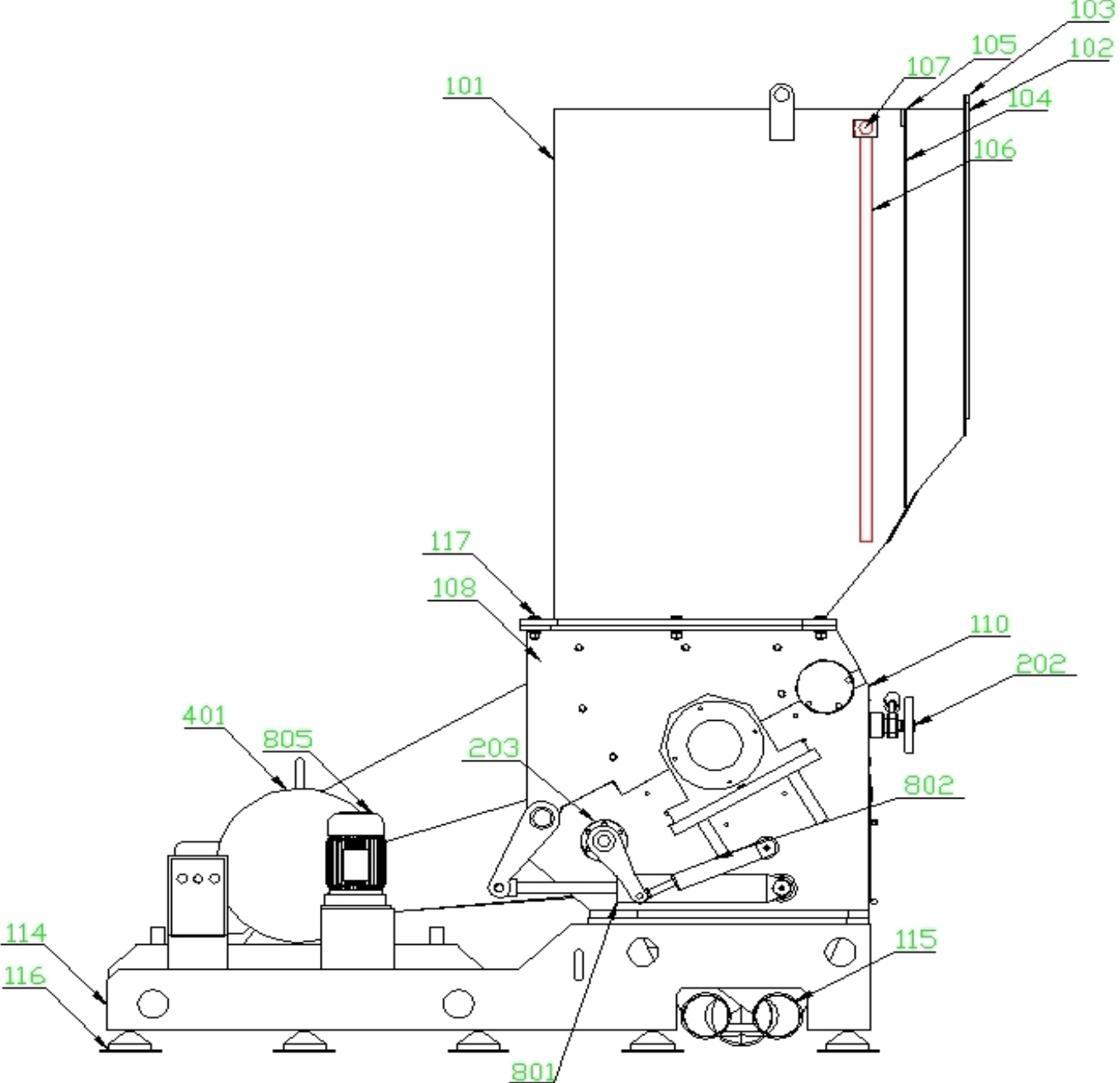



**13.4 Machine section view**

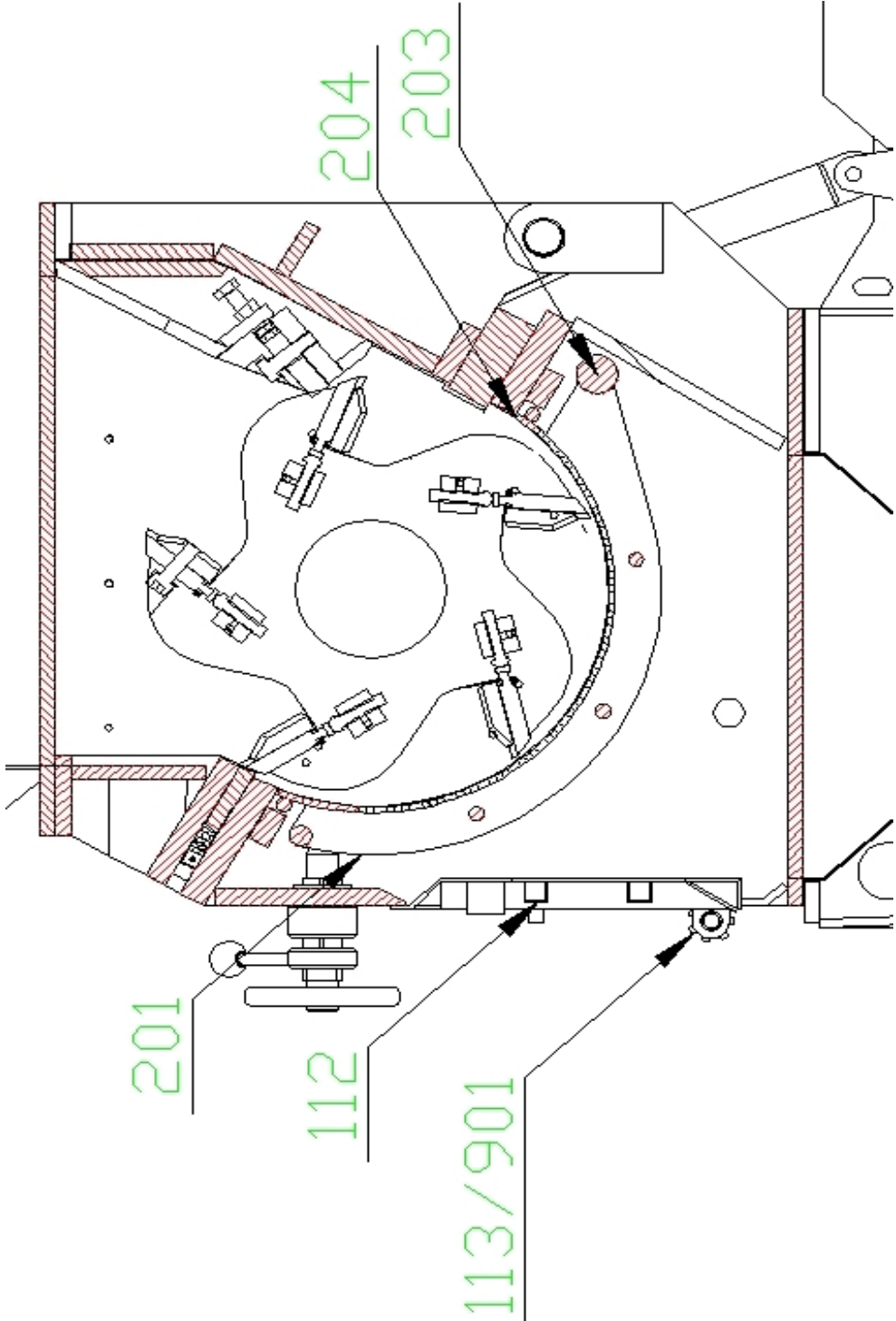

**13.5 S- Rotor**

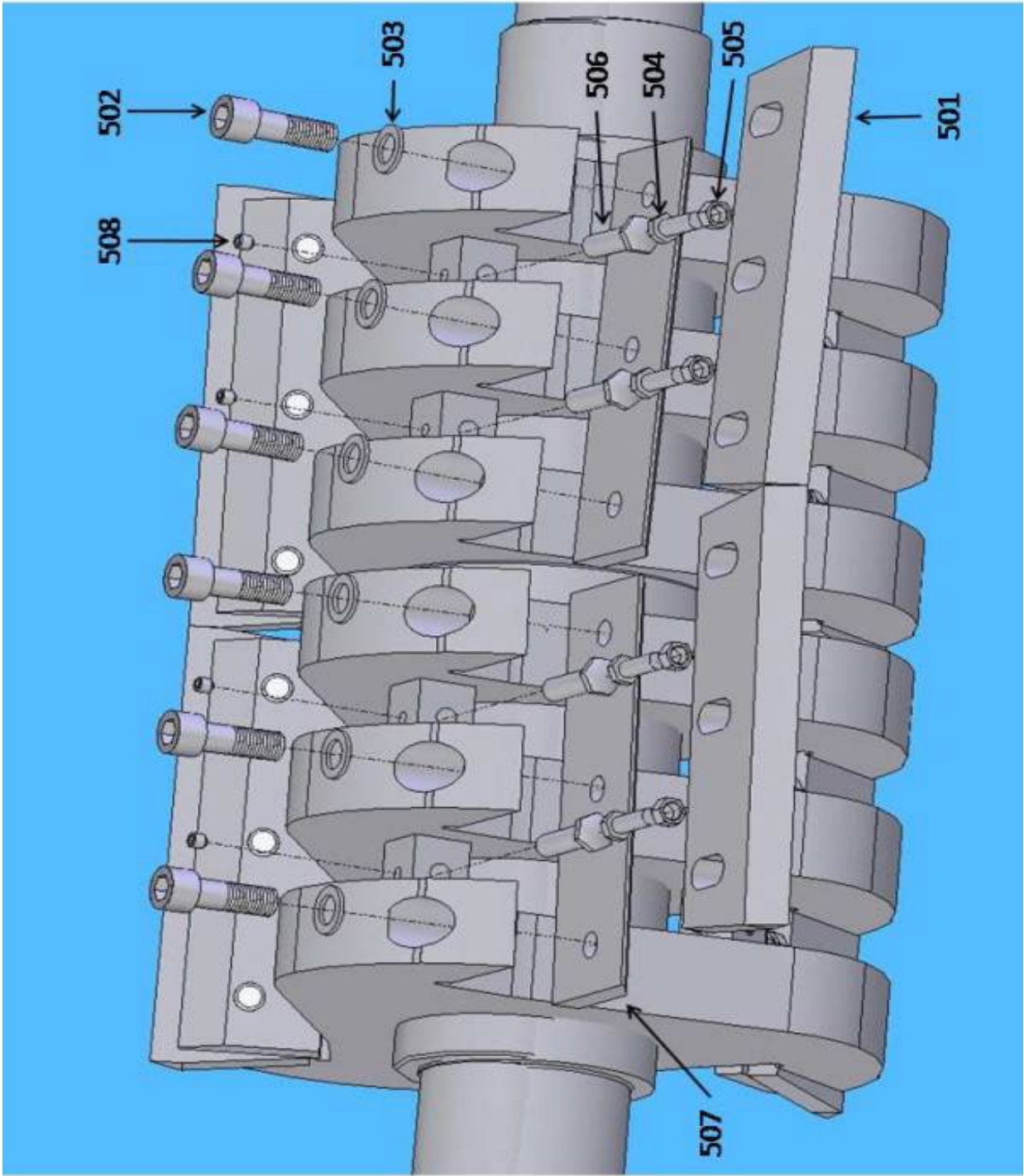

**13.6 H- Rotor**

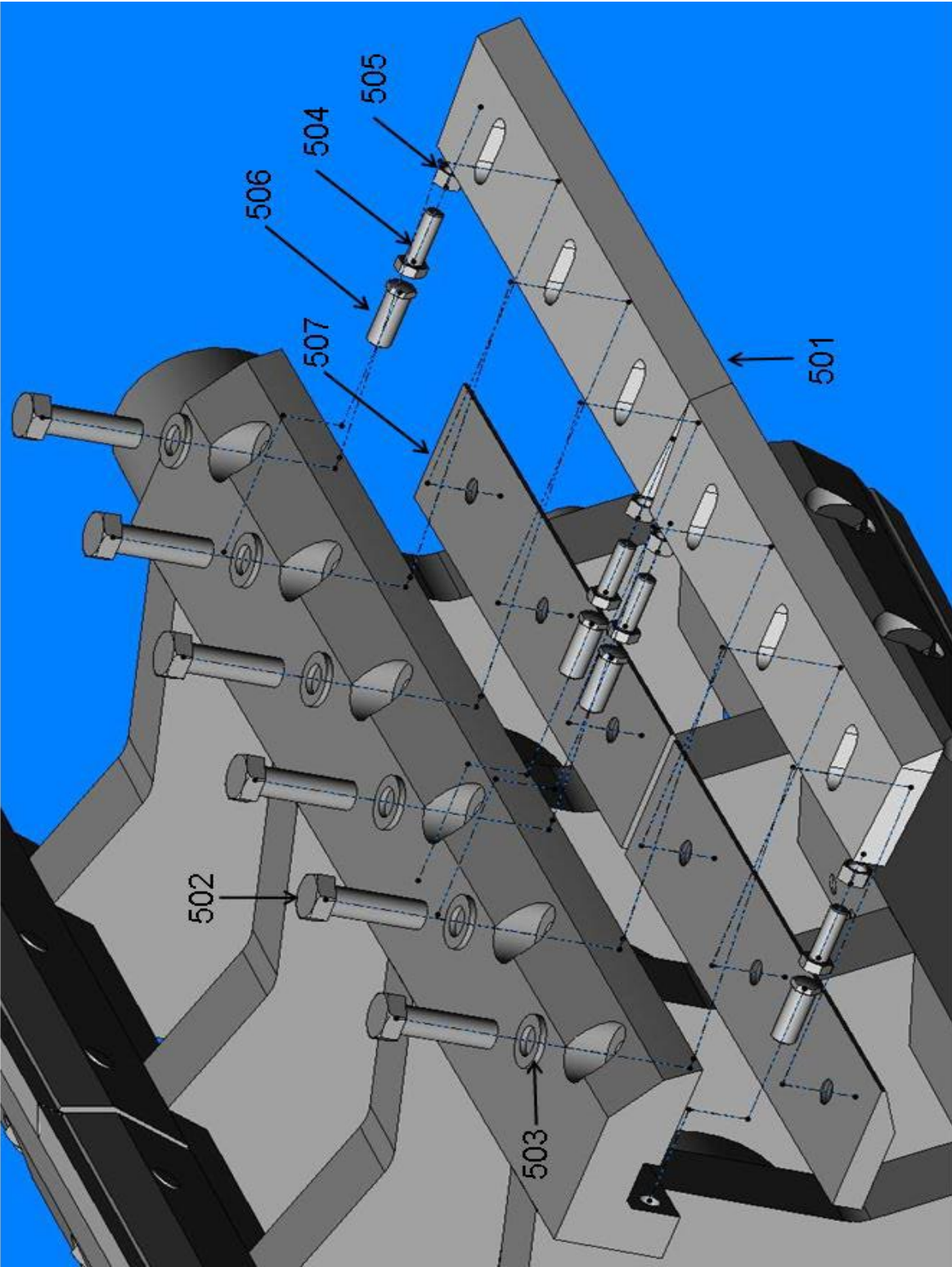



**13.7 Stator knife**

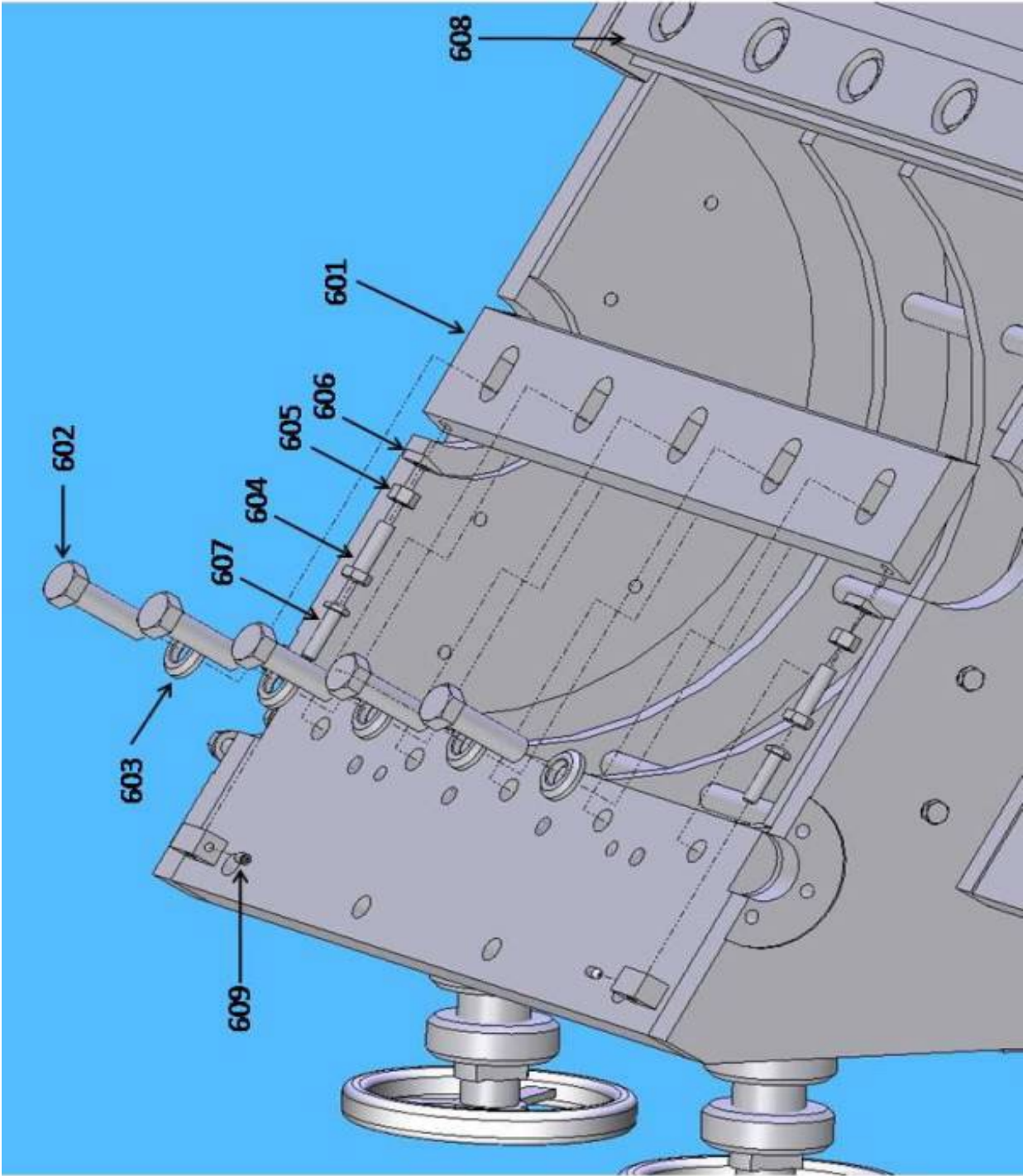

**13.8 Deflection wedge**

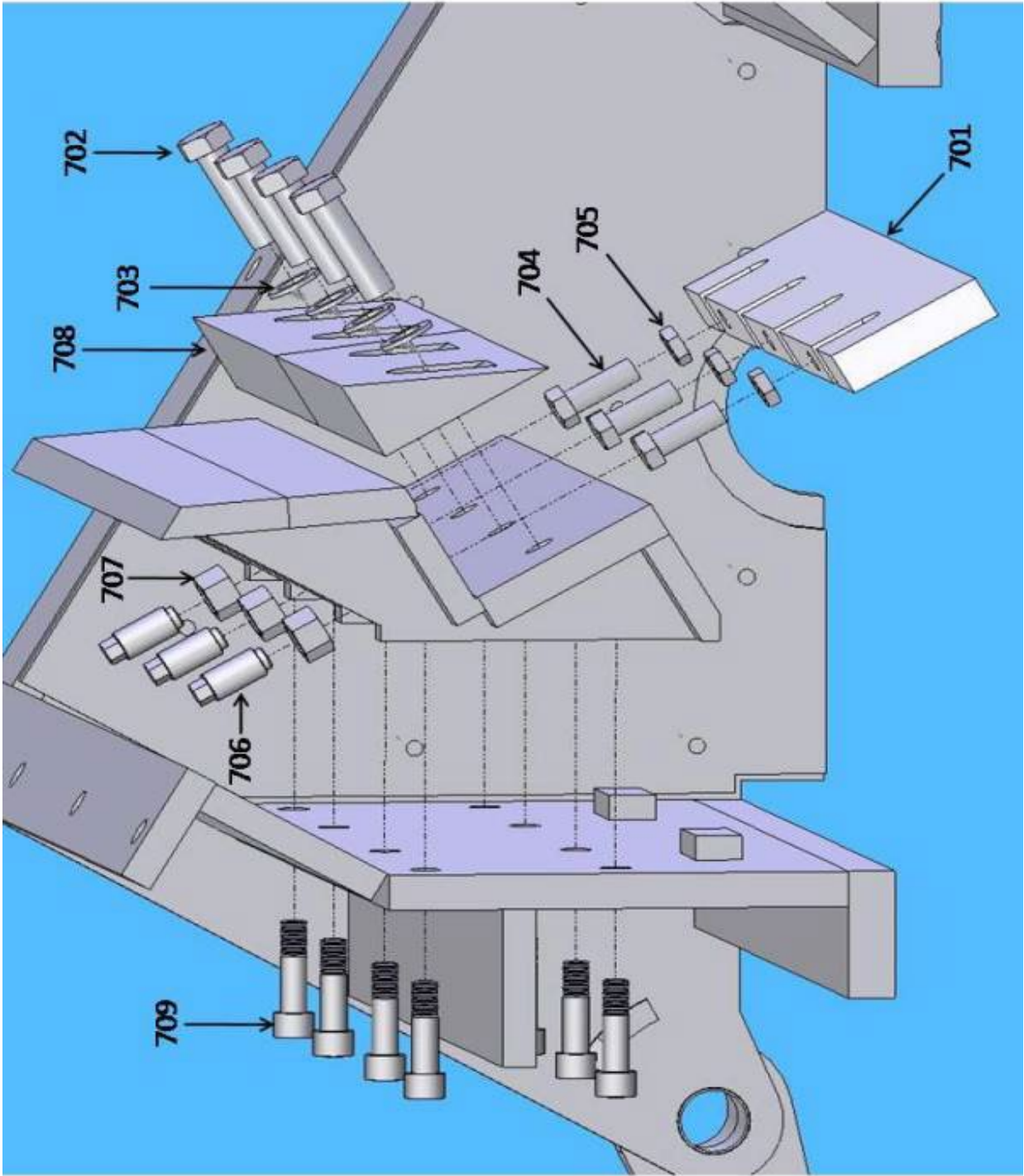

**13.9 Rotor assembly pulley side**

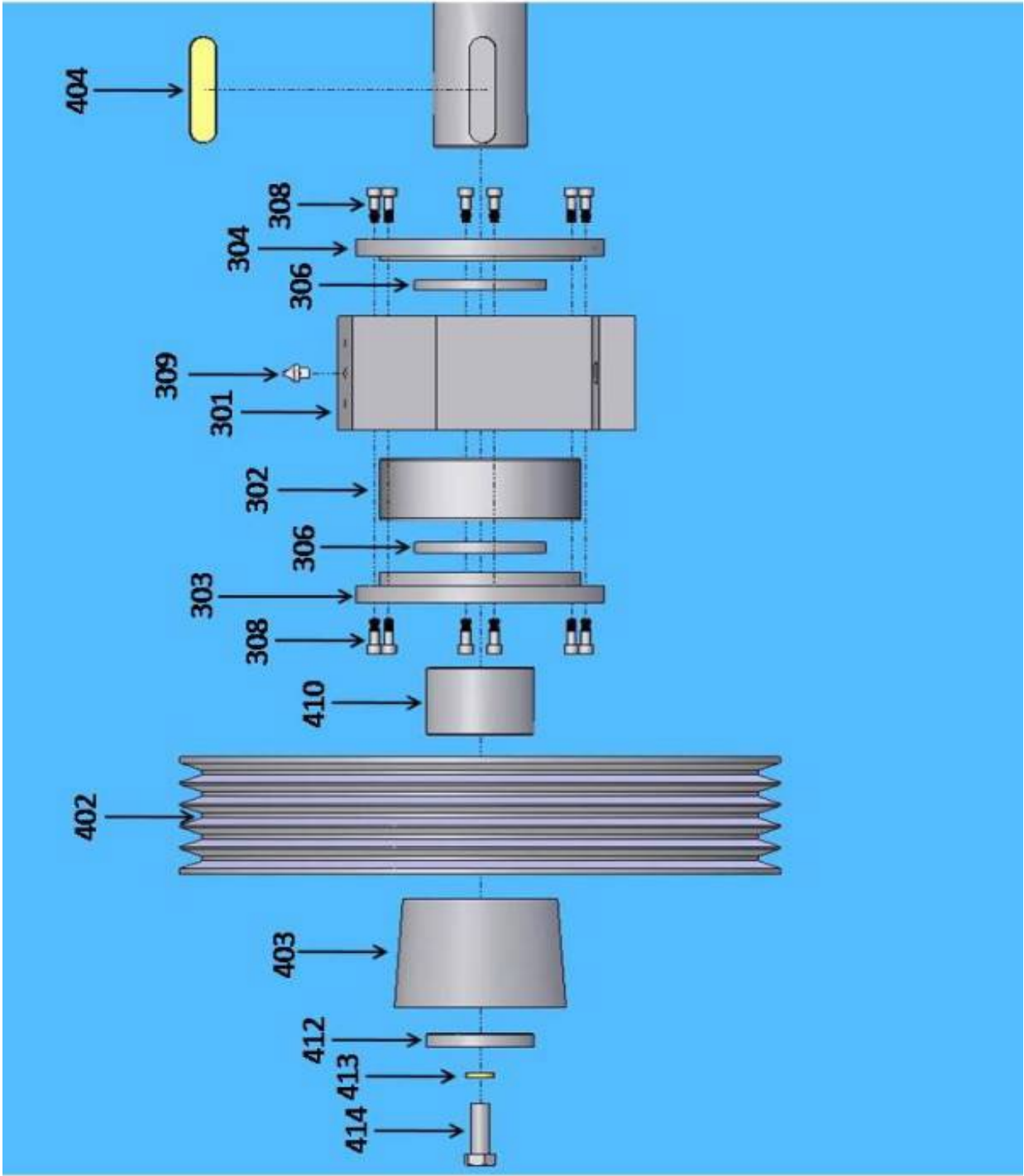

**13.10 Rotor assembly no pulley side**

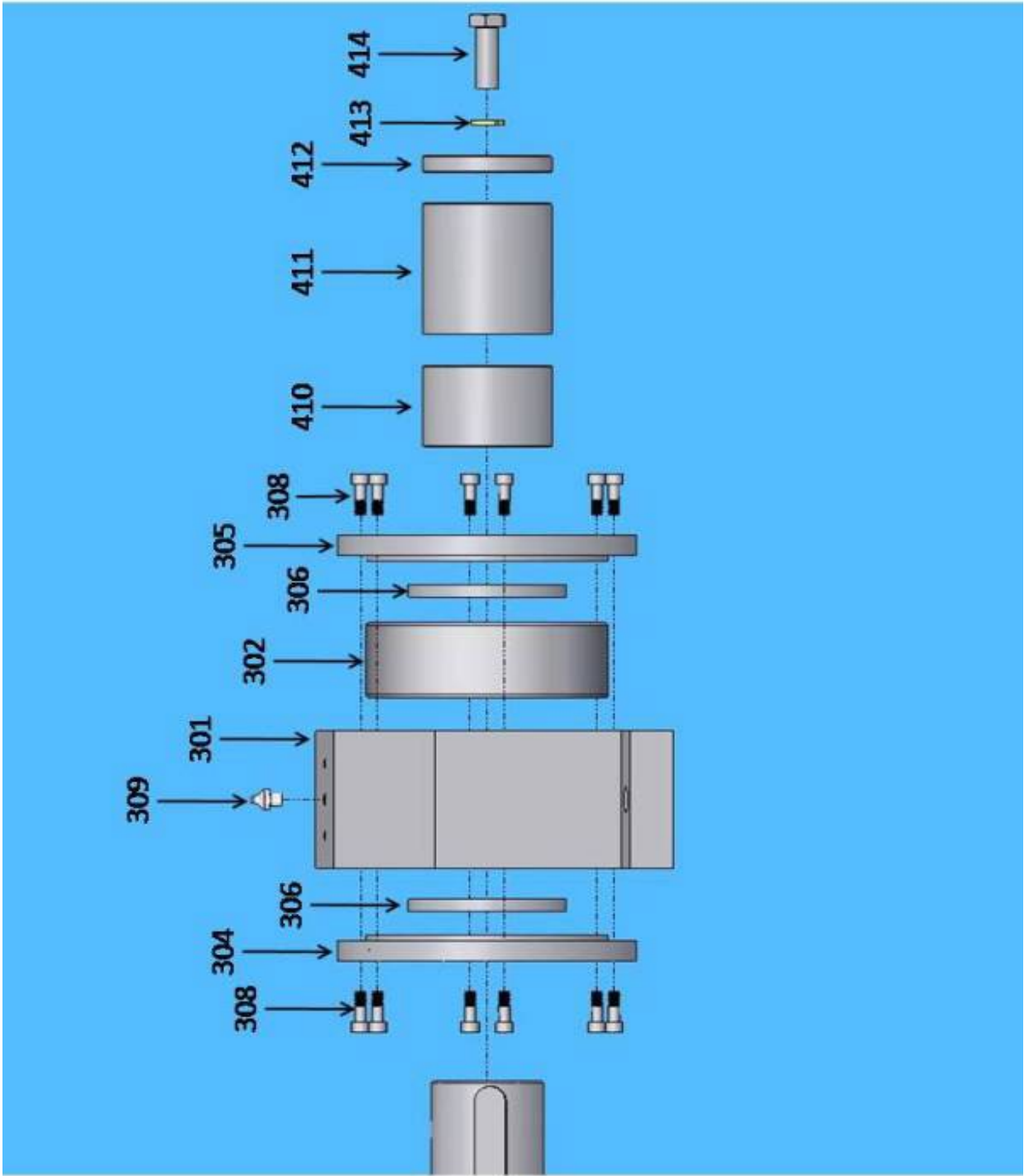

**14 HYDRAULIC UNIT**

**14.1 Hydraulic Diagram**

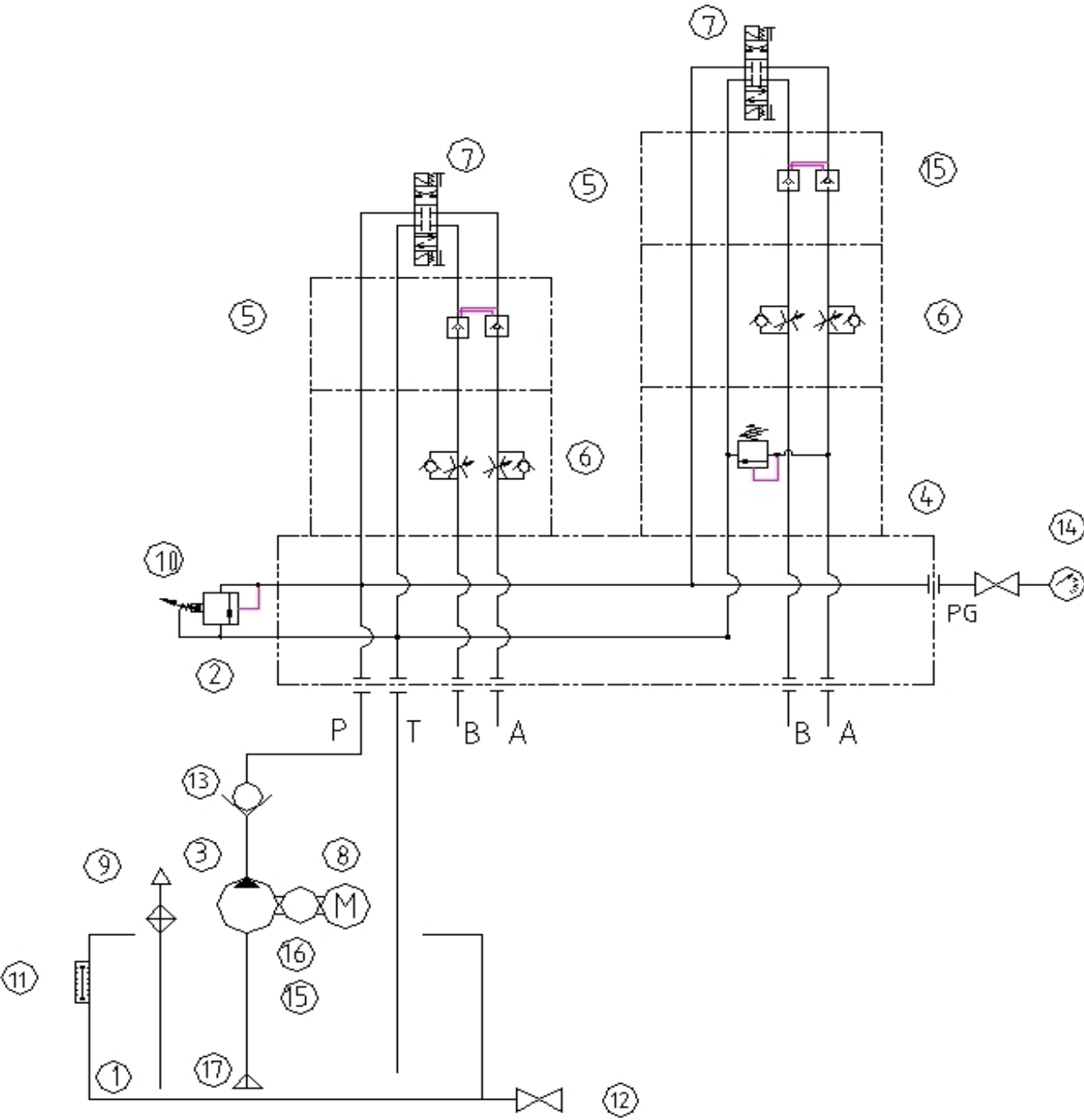



## 14.2 Spare parts list hydraulic unit

Pos	Description	Standard	Pc	Supplier
1	Tank	320x240x268	1	7Ocean
2	Valve block	MFB-113-03-B	2	7Ocean
3	Pump	HGP-1A	1	Xin Hong
4	Modular relief valve	MRV-02-A-2-10	1	7Ocean
5	Modular pilot check valve	MPC-02-W-1-10	2	7Ocean
6	Modular throttle check valve	MTC-02-W-0-10	2	7Ocean
7	Solenoid valve	DSD-G02-2C-DC24-31	2	7Ocean
8	Electric motor	1.5 kW; 2HP-4P	1	ABB
9	Oil lubricator	AB-1162	1	CLC
10	Cartridge relief valve	CRV-60-A-10	1	7Ocean
11	Level gauge	LS-3"	1	CLC
12	Oil discharge plug	PT3-4	1	7Ocean
13	Check valve	CIT-03	2	7Ocean
14	Pressure gauge	AT-63x250kg/cm <sup>2</sup>	1	7Ocean
15	Coupling		1	7Ocean
16	Cover		1	7Ocean
17	Suction filter	MF-04	1	7Ocean

**14.3 Hydraulic Unit**

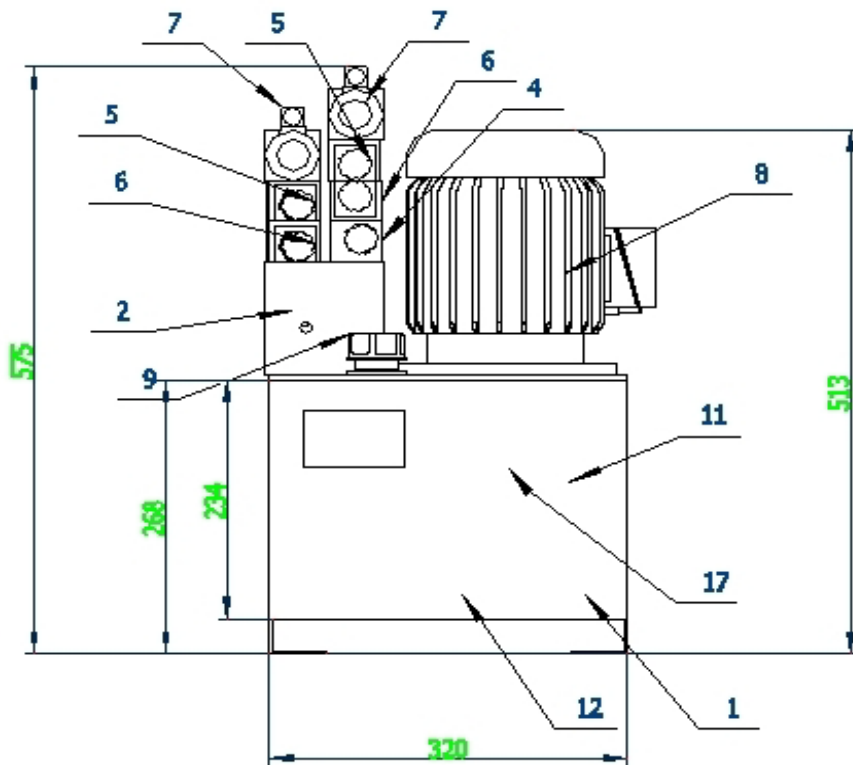
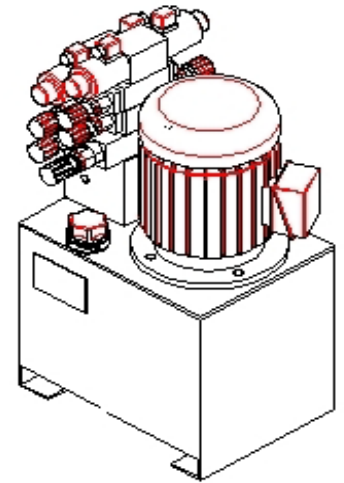
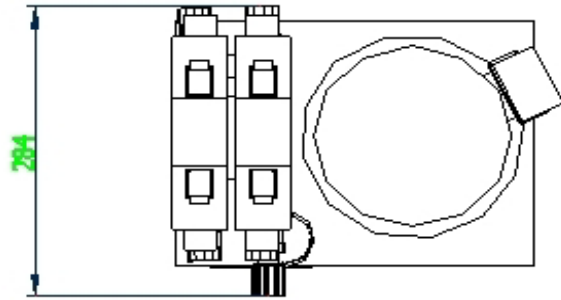

**15 CLARIFICATION FOR PERSONAL TRAINING**

This is to certify that I have attended an in company training for service and operation of the granulator and understand all safety regulations. Further to this I have read and understand the owners' manual.

<b>City</b>	<b>Date</b>	<b>Printed name</b>	<b>Signature</b>

## **16 ELECTRICAL CONNECTION**

The machine should be wired by a qualified electrician.

Please refer to the wiring diagram.

## 17 DIMENSIONS OF STANDARD MACHINE

### 17.1 H 70/100

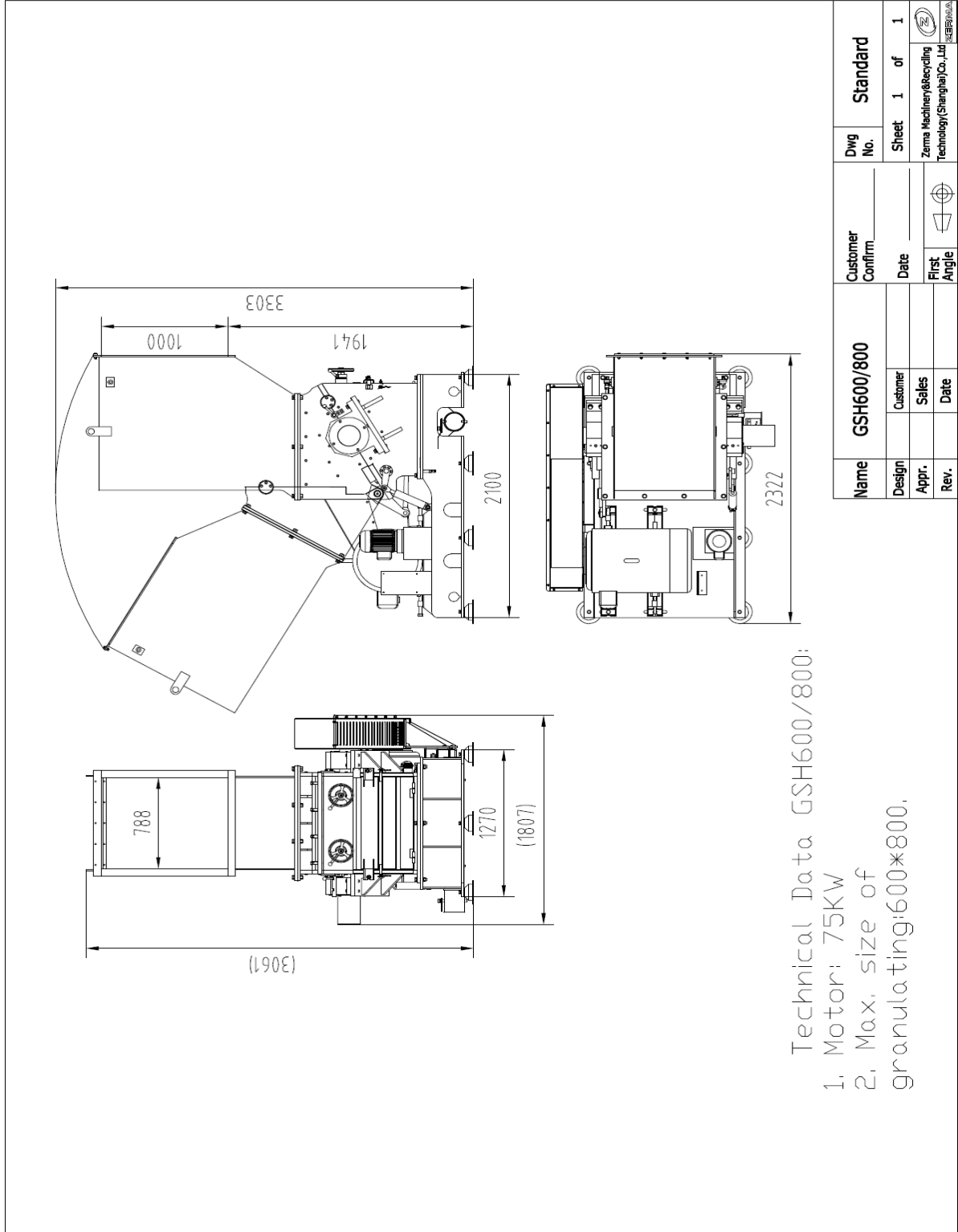

**PART A: Basic machine  
Granulator  
H 60/80-70/100**

**17.2 H 70/100**

Technical Data GSH700/1000:  
 1. Motor: 90KW  
 2. Max. size of granulating: 700x1000.

<b>Name</b>	GSH700/1000			<b>Customer Confirm</b>	<b>Dwg No.</b>	<b>Standard</b>
<b>Design</b>	Customer	Customer	Date	Date	Sheet	1 of 1
<b>Appr.</b>	Sales	Sales	Date	First Angle	Zema Machinery&Recycling Technology(Shanghai)Co.,Ltd	
<b>Rev.</b>						

---

**18      ADDITION**

Documentation Main Drive Granulator  
(PART B)  
Delivery documentation

**ATTENTION:**

**The wiring schematics are located in the control panel in the event that the control panel is a part of the delivery**



**Virtus Equipment**

9120 Centerlinks Commerce Dr., Unit 4  
Fort Myers, FL 33912

239-219-1500

Parts@Virtus-Equipment.com

[www.Virtus-Equipment.com](http://www.Virtus-Equipment.com)