

OPERATING MANUAL

L SERIES



Virtus Equipment

9120 Centerlinks Commerce Dr., Unit 4
Fort Myers, FL 33912

239-219-1500
Parts@Virtus-Equipment.com

www.Virtus-Equipment.com



The Right Machine for Today's
Recycling Requirements

**PART A: Basic machine
Shredder
L 60; L85**

Table of Contents

1	Information on this instruction manual	5
2	Technical data	6
3	General Information	8
3.1	Copyright	8
3.2	Application	8
3.3	Safety	8
3.4	Inspection of goods	8
4	General safety advice	9
4.1	Safe operation of the machine	9
4.2	Use in accordance with the regulations	10
4.3	Liability and Responsibility	12
4.4	Structural changes, spare parts, accessories	13
4.5	Operation manuals from other manufacturers	13
4.6	Noise levels and noise control measures	14
4.7	Work stations	14
4.8	Remaining risks	15
4.8.1	Mechanical dangers	15
4.8.2	Electrical dangers	16
4.8.3	Dangers caused by the control system	17
4.8.4	Thermal dangers	17
4.8.5	Dangers caused by noise	17
4.8.6	Dangers caused by vibration	18
4.8.7	Dangers caused by materials and substances	18
4.8.8	Danger caused by manipulation of the protective devices	18
4.9	Protective devices	19
4.9.1	Safety device for housing flap	19
4.9.2	Safety device for hopper	20
4.9.3	Splash guard	21
4.9.4	Safety markings	21
4.10	Authorized persons	22
4.11	Personal protective gear	23
4.12	Safety measures at the application site	24
4.13	Fire fighting agents	24
4.14	Cleaning agents	24
4.15	Conduct in case of an emergency	24
4.16	Classification of specific safety advice	25

PART A: Basic machine

Shredder

L 60; L85

5	Description of the machine	26
5.1	Grinding material in feed	26
5.1.1	In feed hopper	26
5.2	Machine (Standard execution)	27
5.3	Drive	28
5.4	Rotor and knives	29
5.5	Discharge of grinding material	31
5.6	Control panel	31
6	Initial startup	32
6.1	General Advice	32
6.2	Requirements at the application site	33
6.3	Unloading and installing the machine	34
6.4	Electrical connection	35
6.5	Machine check prior to initial start-up	37
7	Operation	38
7.1	Machine checks before switching on the machine	38
7.2	Switch on machine	38
7.3	Switch off machine	39
7.4	Manual in feed of grinding material	39
8	Maintenance	40
8.1	Safety advice	40
8.2	Maintenance plan	40
8.3	Checking the protective devices	41
8.4	Cleaning the machine	42
8.5	Replacing the gearbox motor	43
8.6	Replacing the rotor	43
8.6.1	Dismounting the rotor	43
8.6.2	Mounting the rotor	44
8.7	Replacing the main bearings	45
8.7.1	Dismounting the main bearings	45
8.7.2	Mounting the main bearing	46
8.8	Lubricating the main bearings	47
8.8.1	Lubrication intervals:	47
8.8.2	Check lubricant quality	47
8.8.3	Replacing or refilling lubricant	47
8.8.4	List of lubricants	49

PART A: Basic machine

Shredder

L 60; L85

8.9	Working on the cutting knives	50
8.9.1	Replacing and checking the cutting knife mountings	50
8.9.2	Checking the condition of the cutting knives	51
8.9.3	Dismounting the rotor knives	52
8.9.4	Dismounting the rotor knife holders	53
8.9.5	Dismounting the stator knives	55
8.9.6	Mounting the rotor knife holders	56
8.9.7	Mounting the rotor knives	57
8.9.8	Mounting the stator knives	58
8.9.9	Sharpening cutting knives	60
8.9.10	Setting the cutting knives	61
8.9.11	Transporting and storing the cutting knives	62
9	Troubleshooting	63
9.1	Machine blocks or switches itself off	63
9.2	Rotor does not grip bulky material	63
9.3	Overheating of the grinding material	63
9.4	Unusual vibrations	63
9.5	Extreme cutter wear	64
9.6	Bearings too hot	64
9.7	Cutting gap alters during operation	64
9.8	Shredder does not start	64
9.9	Shredder blocks when under load	64
9.10	Frequent switching off of grinding material in feed device	64
10	Storage, disposal, transportation	65
10.1	Storage	65
10.2	Disposal	65
10.3	Transportation	65
11	Customer service and spare parts orders	66
12	Spare Parts List L 60	67
13	Spare Parts List L 85	69
14	Clarification for Personal Training	76
15	Electrical Connection	77
16	Dimensions Of Standard Machine	78

1 INFORMATION ON THIS INSTRUCTION MANUAL

Author: VIRTUS EQUIPMENT

No part of this operation manual may be reproduced, distributed or used in any shape or form, stored in a data processing system or translated into another language without written permission.

This operation manual serves to help you to get to know your machine and how to make use of its application possibilities in accordance with the regulations.

The operation manual contains important information on how to operate the machine safely, correctly and economically. Following this advice will help you to avoid danger, minimize repair costs and down times and to increase the reliability and durability of the machine.

Before you begin to work on and with the machine, please read the operation manual thoroughly. Only after you have read and understood the contents of this operation manual may you begin work on and with the machine. Keep this operation manual at the application site for future reference.

References to chapters, plans and other documents as well as key markings are written in *italics*.

↓ Instructions on handling are marked in this way.

The machine is designed in modular system and offers a wide spectrum of variations to do justice to your expectations.

This operation manual is divided into three parts:

1. Part A: Information of the basic machine.
2. Part B: Plans, operation manuals for systems from other manufacturers etc.

Should you wish to order further operation manuals, please quote the machine number.

We wish you every success with your new machine!

PART A: Basic machine
Shredder
L 60; L85

2 TECHNICAL DATA

L 60

Opening cutting chamber	Data in mm:	580x560
Rotor dimension:	Diameter in mm:	310
	Width of cut in mm:	550
Rotor knives:	No. of rotor knives:	26
Stator knives:	No. of stator knives:	2
Rotor speed (50 Hz):	rpm	60
Width:	Data in mm:	1400
Length:	Data in mm:	1000
Height:	Data in mm:	2165
Drive motor:	Power in kW:	11
Screen:	Type and screen hole size dependent on the application and customer requirements.	
Machine weight:	In kg	150
Electrical connection data:	markings are attached to the machine	
Noise level: Depends on plant location and type of grinding material!	Without noise equipment, in dB(A):	

PART A: Basic machine
Shredder
L 60; L85

L 60+

Opening cutting chamber	Data in mm:	580x560
Rotor dimension:	Diameter in mm:	310
	Width of cut in mm:	550
Rotor knives:	No. of rotor knives:	26
Stator knives:	No. of stator knives:	2
Rotor speed (50 Hz):	rpm	60
Width:	Data in mm:	1400
Length:	Data in mm:	1000
Height:	Data in mm:	2165
Drive motor:	Power in kW:	11
Screen:	Type and screen hole size dependent on the application and customer requirements.	
Machine weight:	In kg	160
Electrical connection data:	markings are attached to the machine	
Noise level: Depends on plant location and type of grinding material !	Without noise equipment, in dB(A):	

3 GENERAL INFORMATION

3.1 Copyright

VIRTUS EQUIPMENT holds the copyright for these operation instructions, entrusted to the owner of the shredder for his personal use. This contains technical instructions and drawings which are not be copied complete or in part, distributed or used for reasons of unauthorized competition or for informing others.

3.2 Application

The shredder is designed for size-reduction of plastic material such as PE, PP, and PVC etc. The user is responsible for consequences resulting from incorrect operation: This will lead to the loss of the warranty as well as any compensation claims.

3.3 Safety

The shredder has been constructed in accordance to the general standards of technology and is fitted with safety devices to prevent accidents that could endanger the life or health of the operator. The company operating the unit is responsible for the compliance to the safety regulations. We recommend staff training courses at regular intervals subsequent to initial training during commissioning.

3.4 Inspection of goods

The goods must be inspected by the purchaser to ensure that the delivery is complete and free from damage during transport. In the event of any queries VIRTUS must be informed with regard to missing items or transport damage. In the event of actual transport damage, written notification including photographs should be made and sent to the transport company as well as sent to VIRTUS immediately after delivery.

4 GENERAL SAFETY ADVICE

4.1 Safe operation of the machine

The machine is built according to the state of the art and recognised safety regulations.

It is equipped with protective devices; however there is still the threat of danger in case of incorrect conduct or misuse:

- for the health of the operator and that of other persons,
- for the machine,
- for the environment,
- for material assets belonging to the company and the operator.

All persons involved in:

- transportation and storage,
- start-up and shutdown,
- operation,
- setting and fitting
- maintenance and waste disposal...

of the machine must carefully read and take note of the following advice. However, not only does the general safety advice listed in this chapter need to be observed, but also the safety advice which is added specifically in the other chapters.

Failure to heed this safety advice can lead to loss of all compensation claims.

Furthermore, the existing rules and regulations for the prevention of accidents as well as in house company working, operational and safety regulations have to be observed.

4.2 Use in accordance with the regulations

The operational safety of the delivered machine is only guaranteed for use in accordance with the regulations!

This regulation use is only achieved if the following points are observed and fulfilled.

Manufacturing process and grinding material

The shredder is suitable exclusively for the grinding of material, which corresponds to the agreed customer-specific specifications in all points (see *Contract of sale*).

Any other work or design will differ from the specified requirements. VIRTUS EQUIPMENT will not be held responsible. The specified requirements also include all information found in the owner's manual such as maintenance and service. Any change in the specifications or requirements must be brought to the attention of VIRTUS .

Suction unit

If emissions occur during grinding of material, which exceed the permissible legal values for contaminants in the air, the shredder may only then be operated when the customer has installed a suitable air suction device on site.

Safety device for the in feed hopper

In the case that your design of the shredder does not contain any additional in feed device (e.g. nip roll feed device), the in feed hopper must be safeguarded in a suitable way against persons reaching in or falling in.

If, without our knowledge, the machine is installed "underground" on site, it is deemed to be installation contrary to the intended purpose. The attached manufacturer's declaration alone, stating that the machine may not be operated without additional measures

Connection of the Emergency Stop button

The machine may only be operated with the installed Emergency Stop buttons. In case no Emergency Stop buttons have been installed, an Emergency Stop button must be mounted on the control cabinet, the second on the material in feed.

Miscellaneous:

- The working conditions and instructions specified in this operation manual must be adhered to.
- The machine is not suitable for operation in an explosive environment.
- Faults, which can impair safety, are to be reported immediately and eliminated by a trained and skilled specialist.
- The machine may only be used in the industrial application range.

General Requirements Safety Information

- The service and maintenance in this owner's manual must be performed on a regular basis.
- The machine is not designed for operation in a volatile environment.
- Faults that could be a safety hazard must be reported immediately and repaired by experienced personal.
- The machine must only be installed in an industrial type building.

Known uses not in accordance with the regulations

Never grind materials, which do not correspond to the agreed customer-specific specifications. If this occurs, there could be a danger to persons and the possibility of the machine being damaged.

Informal Safety Requirements

The owner's manual should always be located near the machine. New excerpts or additions to the owners' manual must always be inserted to include any safety requirements or environmental requirements.

All safety or caution signs must be visible and easy to read.

4.3 Liability and Responsibility

The General Conditions of Sale and Delivery apply. These conditions apply no later than the end of the contract. Liability and or responsibility to seller do not apply to the following;

- Equipment is not properly used for its specific application.
- Non-conforming installation, commissioning or service of the machines.
- Operation of the equipment without proper safety guards.
- Not conforming to the directions of the owners' manual regarding transport, storage, installation, commissioning or servicing the equipment.
- Any designs alterations on the machine.
- Any changes on the program logic which can alter the machine operation or electrical function.
- Changes in the logic function.
- Improper maintenance or servicing of the machines that can lead to extraordinary wear
- Improper servicing of equipment
- Spontaneous crashes caused by foreign objects falling into the machine or acts of God

We honour a 12 month guarantee valid after delivery under the conditions that originally delivery or original parts from VIRTUS EQUIPMENT are used or accepted for use in accordance with our owner's manual.

Otherwise the guarantee will be considered invalid. Excluded are wear and tear parts such as knives, screens, drive belts, bearings, etc.

4.4 Structural changes, spare parts, accessories

For reasons of safety, remodelling and/or modifications to the machine, in particular to the electrical devices, are only permissible by arrangement with the manufacturer!

Replace faulty parts immediately. Only use original spare parts or spare parts from other manufacturers, which correspond to the original spare parts with regards to function, stress and safety. This applies in particular for reasons of EMC (electro-magnetic compatibility) for electrical components.

The use of unsuitable parts can impair resistance to relays and increase the emission of relays!

If parts are replaced which are relevant for safety, they must be checked afterwards for proper function.

Only use accessories, which have been approved by the manufacturer. Use of accessories can change how the machine works. You must therefore observe the additional advice for your work and your safety. Read *Part B: Accessories*, before you commission the machine.

4.5 Operation manuals from other manufacturers

Integrated in the machine are systems from other manufacturers. When working on or with these systems, please observe the advice in the operation manuals from the respective manufacturer. These operation manuals are enclosed with the machine documentation.

4.6 Noise levels and noise control measures

The L series shredder standard design is without a sound proof enclosure.

The noise level of the shredder at idle speed is approximately 85 dB (A).

Especially by rigid materials soundproofing is recommended due to a noise level of up to 120 dB (A) when in operation.

In order not to exceed the noise level of 85 dB (A) is the purchaser required to provide soundproofing.

The noise level can be affected by foundation static or dynamic, aux. blowers etc. or other additional equipment. Therefore it is necessary to actually determine if the noise level is directly coming from the machine or accessory equipment.

VIRTUS EQUIPMENT offers the following equipment to reduce the noise levels:

- Two piece soundproof box (one piece stationary, one piece moveable) also available with soundproof hopper.
- Walk-in type soundproof enclosure.



CAUTION

The user or purchaser is responsible for compliance with the instructions and procedures!

4.7 Work stations

During normal operation, the work station is the station at the in feed of the grinding material.

For maintenance work, the whole area around the machine is at your disposal.

4.8 Remaining risks

The machine is constructed so that you are able to operate it safely. Structurally non-avoidable dangers are prevented as well as possible by the protective devices. A certain remaining risk does however always remain! Being aware of these remaining risks of the machine will help you to structure your work more safely and in so doing to avoid accidents.

To avoid danger, please observe in addition the specific safety advice in the individual chapters.

4.8.1 Mechanical dangers

Type of danger:	Danger of crushing by heavy parts falling down or falling over.
Activity:	Unloading and transporting the machine or machine components.
Possible consequences:	Serious injury could result.
Preventative measures:	Wear personal protective gear. Follow the instructions in this <i>Operation manual</i> .

Type of danger:	Danger of cutting caused by sharp cutting knives, even when the rotor is stationary.
Activity:	Knife replacement, knife setting, and knife sharpening, other maintenance work.
Possible consequences:	Serious injury, particularly to hands and fingers can result.
Preventative measures:	Wear personal protective gear. Follow the instructions in this <i>Operation manual</i> .

Type of danger:	Danger of crushing when opening/closing the maintenance doors on the front side of the machine.
Activity:	Maintenance work.
Possible consequences:	Serious injury can result.
Preventative measures:	Ensure that no persons are in the danger area while closing the door.

Type of danger:	Tripping over cables and other objects lying around.
Activity:	All activities.
Possible consequences:	Serious injury can result.
Preventative measures:	Lay cables in accordance with the regulations. Keep work station clean and tidy.

**PART A: Basic machine
Shredder
L 60; L85**

Type of danger:	Danger of crushing, cutting and amputation caused by run-down of the rotor.
Activity:	Maintenance work.
Possible consequences:	Serious injury or death can result.
Preventative measures:	The maintenance doors must always be tightly locked during operation. Do not make the run down safety devices ineffective by using technical aids or other manipulations. Never check by hand whether the rotor has come to a stop.

4.8.2 Electrical dangers

Danger:	Direct or indirect contact with live parts in the terminal box.
Activity:	Maintenance work, start-up.
Possible consequences:	Serious injury or death.
Preventative measures:	Only trained electricians may only carry out all work on the electrical equipment. If work is necessary on parts, which conduct dangerous voltage, a second person should be called in who can break the power supply in case of emergency. The yellow-marked lines conduct voltage even when the machine is switched off (main switch to 0). Only use original safety fuses with stipulated intensity of current. Faulty electrical components must be replaced immediately. If faults occur in the electrical energy supply, switch machine off immediately. The terminal box must be locked during operation. Before opening the terminal box: Main switch to 0.

**PART A: Basic machine
Shredder
L 60; L85**

4.8.3 Dangers caused by the control system

Type of danger:	Danger caused by failure of the Emergency Stop function.
Activity:	All activities.
Possible consequences:	Serious injury or death.
Preventative measures:	It must be guaranteed that failure of an Emergency Stop button is displayed and leads to an immediate stop of the machine.

4.8.4 Thermal dangers

Type of danger:	Danger of fire and explosion caused by throwing dangerous objects (e.g. spray cans) into the shredder.
Activity:	Grinding.
Possible consequences:	Serious injury or death can result.
Preventative measures:	Only grind material which corresponds to the agreed customer-specific specifications in all points.

4.8.5 Dangers caused by noise

Type of danger:	Damage to hearing.
Activity:	All activities.
Possible consequences:	Diminished hearing, headaches, impaired balance, and deterioration of concentration.
Preventative measures:	Reduce noise emissions by taking suitable measures. Wear ear protection.

**PART A: Basic machine
Shredder
L 60; L85**

4.8.6 Dangers caused by vibration

Type of danger:	Instability of the machine caused by vibration.
Activity:	All activities.
Possible consequences:	Serious injury can result.
Preventative measures:	Install the machine according to the instructions of this <i>Operation manual</i> and the <i>Assembly drawing</i> .

Type of danger:	Loosening of the cutting knife mountings caused by vibration.
Activity:	All activities.
Possible consequences:	Serious injury can result.
Preventative measures:	Check the cutting knife mountings regularly according to the instructions in this operation manual.

4.8.7 Dangers caused by materials and substances

Type of danger:	Inhalation of grinding dust.
Activity:	All activities.
Possible consequences:	Diseases of the respiratory tract etc.
Preventative measures:	Mount a suitable air suction device. Wear breathing equipment if necessary. When cleaning the machine do not blow out grinding dust, use suction instead.

4.8.8 Danger caused by manipulation of the protective devices

Type of danger:	Danger of crushing, cutting and amputation.
Activity:	All activities.
Possible consequences:	Serious injury or death can result.
Preventative measures:	Never make the protective devices ineffective. Check the protective devices regularly for proper functioning according to the specifications given in this operation manual.

PART A: Basic machine
Shredder
L 60; L85

4.9 Protective devices

The machine may under no circumstances be operated without these protective devices or with faulty or manipulated protective devices.

4.9.1 Safety device for housing flap

Illustration:
Safety device for housing
flap



The shredder can only be operated if the housing flap is fixed and the screws are tightened. Otherwise the safety switch is activated. If the housing flap will be opened during operation, the safety switch is activated, thus switching off the machine.

PART A: Basic machine
Shredder
L 60; L85

4.9.2 Safety device for hopper

Illustration:
Safety device for hopper



The hopper can be opened or pivoted upwards for maintenance work and for cleaning. It is connected with the cutting chamber by means of a joint.

It can be opened manually with the mounted hand winch.

Therefore the hopper is safeguarded against opening while running.

If the hopper will be opened during operation, the safety switch will be activated and the machine stops.

PART A: Basic machine

Shredder

L 60; L85

4.9.3 Splash guard

In case that the grinded material is introduced directly via the in feed hopper, the input opening is provided with a splash guard to prevent fly out.

Illustration:
Splash guard



4.9.4 Safety markings

Safety markings are attached to the machine. If one of these markings becomes detached or is no longer recognisable, it must be replaced. You can order new markings at specialist shops or from us (see *Customer service and spare parts orders*).

4.10 Authorized persons

Only authorized personnel may only carry out work on the machine. Observe the legally permissible minimum age!

As a basic rule, only persons who have received training on the machine may only operate the machine.

Personnel, who are still to be trained or receive instruction on the machine, may only work on the machine under constant supervision by an experienced person.

The company operating the machine must make the operation manual accessible to the machine user and ensure that he has read and understood it. Only then may he put the machine into operation.

Responsibility for the different jobs on the machine must be clearly established and adhered to. There must be no unclear areas of authority, as this could endanger the safety of the machine user.

If several persons work on the machine, a detailed division of workstations should be set up.

Only trained electricians may only carry out all work on the electrical equipment.

Only authorized specialist personnel may only eliminate faults on the control system.

All work related to installation, only trained specialist personnel having received instruction on the machine might only carry out fitting and maintenance of the machine.

The operator must make sure that only authorized personnel work on the machine. The operator is responsible for the safety of third persons in the working area of the machine.

PART A: Basic machine
Shredder
L 60; L85

4.11 Personal protective gear

Wear close-fitting clothing. Jewellery and hair must be worn so that they cannot be pulled into the machine by moving parts.

The following protective gear must be worn when carrying out the following tasks:

	Safety helmet	Safety boots	Safety gloves	Safety goggles	Ear muffs
Unloading machine.	x	x	x		
Connecting machine.		x			
Operation.		x	x	x	x
Cleaning.		x	x	x	
Maintenance of bearings.		x			
Maintenance of gearbox motor.		x			
Maintenance of cutting knives.		x	x		
Knife sharpening.		x	x	x	x

If necessary, protect yourself with breathing equipment (in addition to the air suction device) before inhaling substances harmful to the health.

4.12 Safety measures at the application site

Requirements at the application site: see chapter *Initial Start-up*.
The machine must be erected horizontally on a horizontal surface and in a stable manner.

Ensure by means of appropriate in house orders and controls that the environment of the work station is always clean and clear of obstructions.

4.13 Fire fighting agents

In the case of fire, disconnect the power supply of the machine or pull out the mains plug. Extinguish the fire from a distance of several meters using a fire extinguisher suitable for the machine and the grinding material.

4.14 Cleaning agents

Only use suitable cleaning agents to clean the machine and in doing so, the advice of the manufacturer is to be heeded. Please be aware that unsuitable cleaning agents (e.g. thinners) can damage the paint of the machine as well as the cables and plastic parts.

4.15 Conduct in case of an emergency

The machine may only be operated with the installed Emergency Stop buttons. An Emergency Stop button must be mounted onto the control cabinet, the second onto the grinding material in feed.

Emergency Stop:

- ↓ In case of emergency, immediately press one of the *Emergency Stop buttons*.

CAUTION

The EMERGENCY STOP must be activated in all situations whereby injury or damage could result!







Reoperation:



- ↓ Eliminate cause of Emergency Stop.
 - ↓ Unlock *EMERGENCY STOP BUTTON*.
 - ↓ Acknowledge fault.
- The machine is now ready for operation again.

4.16 Classification of specific safety advice

The specific safety advices in the following chapters of this operation manual are classified as follows:

 DANGER	
	Indicates an immediately threatening danger. If you do not take avoiding action, death or serious injury will result.

 WARNING	
	Indicates a possibly dangerous situation. If you do not take avoiding action, death or serious injury could result.

 CAUTION	
	Indicates a possibly dangerous situation. If you do not take avoiding action, slight or minor injury could result.

This safety advice refers to the remaining risks for certain working steps and helps you to work safely with the machine. In addition to the safety advice above, there are also the hint and the tip.

	HINT Indicates a possibly harmful situation. If you do not take avoiding action, the machine could be damaged.
---	---

	TIP Indicates application tips and other particularly useful information.
---	--

5 DESCRIPTION OF THE MACHINE

5.1 Grinding material in feed

The grinding material can be fed into the shredder in the following ways:

- Manual in feed of the grinding material directly into the in feed hopper.
- Manual in feed of the grinding material with the help of an additional in feed device (e.g. hydraulic feeding unit).
- Automatic in feed of the grinding material by means of an additional in feed device (e.g. conveyor belt).

5.1.1 In feed hopper

The grinding material in feed ensues via an in feed hopper, which is formed so that the grinding material can be delivered correctly and safely.

Illustration:

Standard hopper



PART A: Basic machine
Shredder
L 60; L85

5.2 Machine (Standard execution)

Illustration:

- (1) Base frame
- (2) Housing flap
- (3) Gear box motor
- (4) Control panel
- (5) Hand winch
- (6) Hopper
- (7) Discharge area

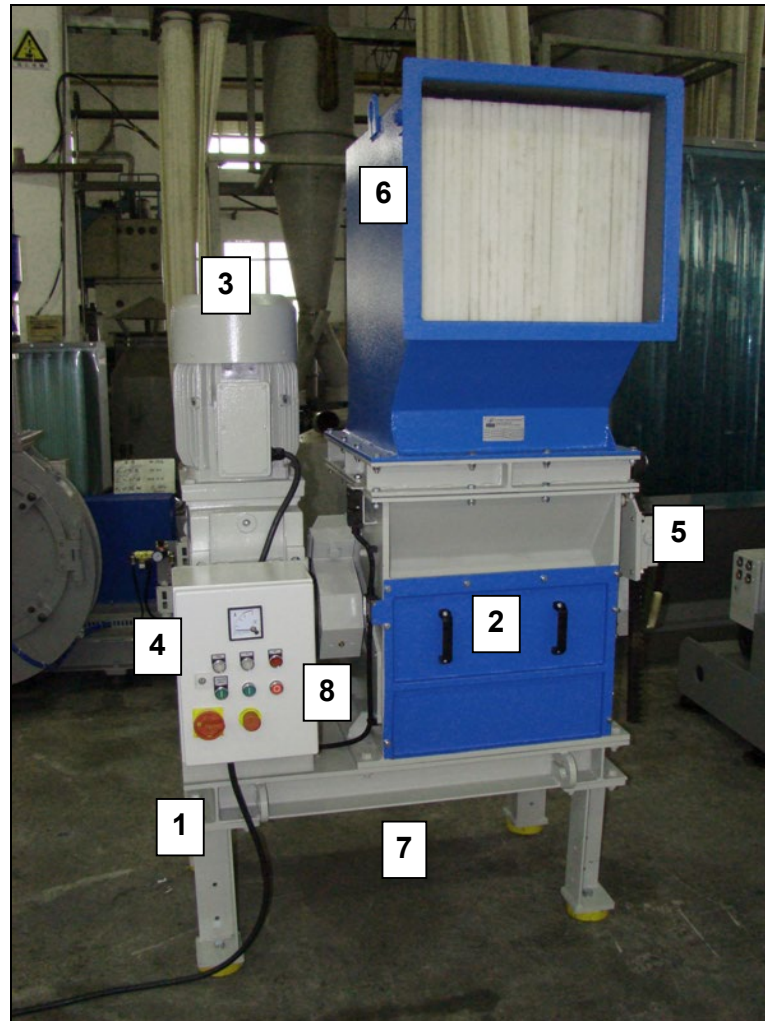

PART A: Basic machine
Shredder
L 60; L85

5.3 Drive

The drive of the rotor ensues by means of an electric helical gear motor. The motor is flanged on the rotor and fixed on the base frame.

Please observe the operation manual from the manufacturer!

Illustration:
Drive Motor



5.4 Rotor and knives

The material is ground between the knives assembled on the rotor and the stator knives which are mounted in a fixed position in the machine lower section.

All rotors are equipped with square knives. These knives make light work of the heaviest pieces.

The knives have four corners, so that they can be easily turned once a corner has worn out.

The design of the rotor has a significant influence on the quality of the grinding process and its results. The rotor construction, the type of knife mounting and the number of knives have all been exactly matched to your task allocation.

Illustration:
(1) Rotor knife
(2) Stator knife

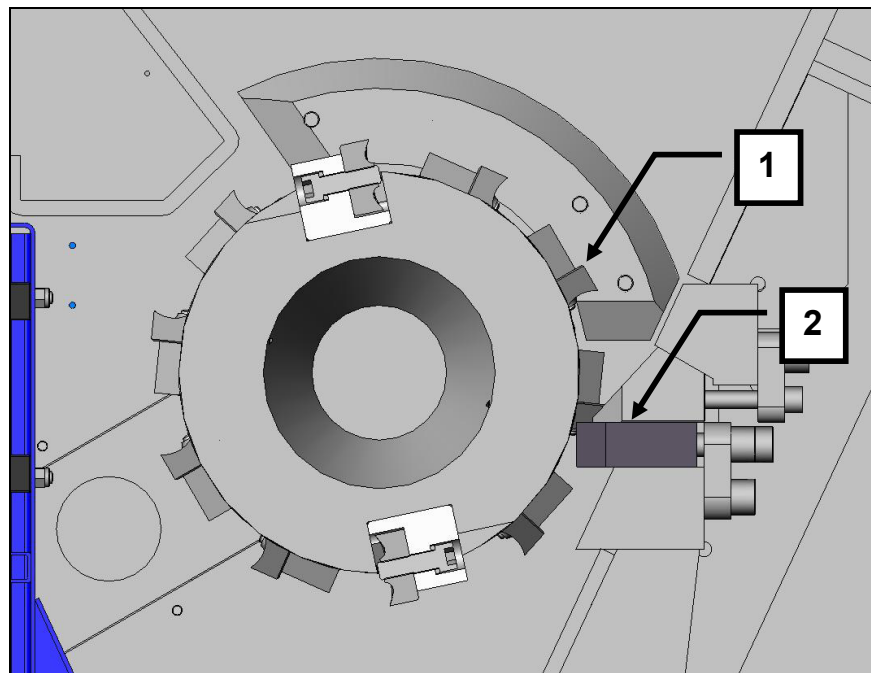

PART A: Basic machine
Shredder
L 60; L85

Illustration:
(1) Rotor knife
(2) Material outlet

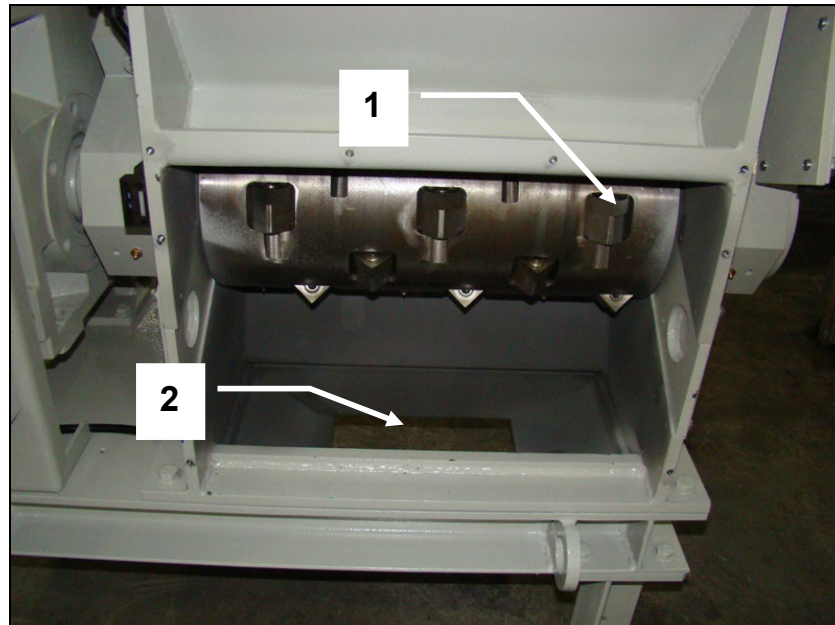

The rotor is accessible after opening the lower housing flap and removing the screen.

The rotor is arranged on roller bearings, which are situated outside the housing. Gearbox motor is attached to the rotor axis. The rotor is dynamically counter balanced and has vibration-free concentricity.

**PART A: Basic machine
Shredder
L 60; L85**

5.5 Discharge of grinding material

Normally the ground material will be discharged by a box.

Options:

Discharge with conveyor

5.6 Control panel

Illustration:
Control panel

- (1) Main switch
- (2) Emergency stop
- (3) Ampere meter
- (4) Control lights
- (5) Start button
- (6) Stop button
- (7) Reset button

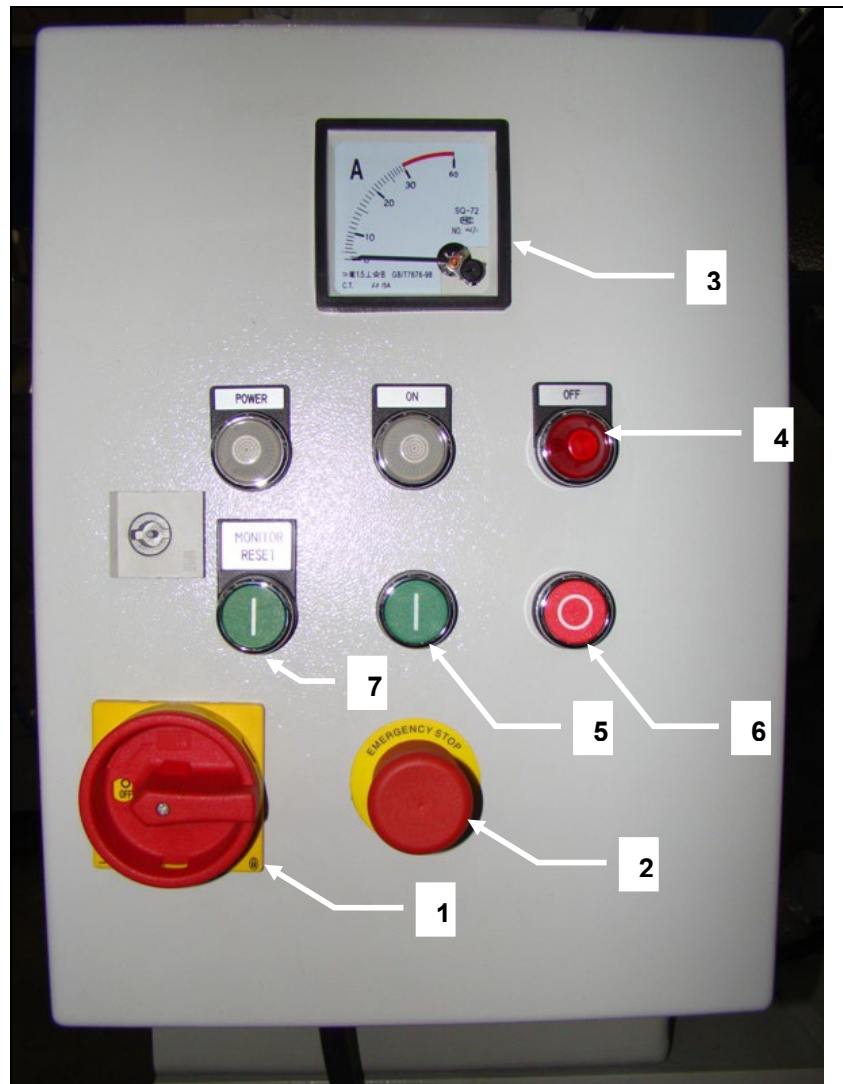





6 INITIAL STARTUP

6.1 General Advice

All work related to start-up may only be carried out by trained specialist personnel.

Check the machine for possible transportation damage or other damage. Should you determine damage, have this confirmed by the freight company and please report this to us in writing immediately after delivery. When starting up for the first time and after setting up ready for service, you must carry out the necessary checks according to the chapter *Machine Check prior to Initial Start-up*.

 WARNING	
	Check the oil level of the gear box, before operating the machine. Please observe the operation manual from the manufacturer!

 WARNING	
	Fill oil into the hydraulic tank. Please observe the operation manual from the manufacturer!



6.2 Requirements at the application site

The site of application for the machine must exhibit the following features:



- Enclosed space.
- The ground must exhibit sufficient load-bearing capacity (you can find the machine weight in the *Chapter Technical Data*). The unevenness of the ground surface may not exceed 5 mm.
- The machine must be freely accessible from all sides.
- There must be sufficient room available for operating and service personnel.
- Spatial requirements: see *Assembly drawing*. All hinged parts must be able to be opened completely.
- Vibration-free environment.
- The application site must be well-lit.
- The machine may not be exposed to direct radiation caused by radiators or the sun.
- Room temperature: +5° to +40°C
- Relative atmospheric humidity according to DIN 40040:
15 to 70 % (indoor)
By humidity levels higher than 70 %, apply anticorrosive agent to the metallic-finished machine parts. Insulation for the tropics is also necessary.
- The machine may not be operated within range of static discharges or strong magnetic fields as this could lead to faults in the machine control system.

6.3 Unloading and installing the machine

The machine or the machine components are packed so that they will arrive to you safely. To see how the machine is packed or should be packed, please see the *Packing plan*. For unloading the packaged machine or machine components you may use a suitable crane or forklift.

 WARNING	
	Suspended load. Falling loads can cause serious injury or death. Only use a crane or a forklift which is suitable for the weight and the dimensions of the load.
	Also use a suitable stopping means and pay attention to the gravity centre location. Do not step under the suspended load. Wear a safety helmet in addition to your basic protective gear.



- ↓ After unloading, remove the packaging material and all transportation safety devices.
- ↓ In the case that the shredder and its accessory components have been delivered as individual items, mount these at the site of ap
- ↓ in accordance with the data given in the *Assembly drawing*. Only in this way can it be guaranteed that there are sufficient delivered piping parts, tubing and cable connections and that the linking places match.

 WARNING	
	Overtipping or falling machine. Serious injury or death can result. In the case that you wish to erect the granulator over a pit, on a frame or on a platform, you must secure the machine by putting mounting screws through the holes on the mounting pads (see <i>Assembly drawing</i>). If assembling the machine on solid ground, this safety device is not absolutely necessary.

- ↓ Align the machine horizontally with the help of a suitable spirit level.
Do not use blocks to place underneath the machine, use instead metal strips in order to prevent buckling of the base frame. Make sure that an even distribution of weight is achieved on all the points of support.



6.4 Electrical connection

Electrical connections should only be made by a qualified electrician.

 WARNING	
	<p>Dangerous voltage. Touching live parts can lead to serious injury or death. All work which relates to the electricity of the machine may only be carried out by trained electricians. Observe the currently effective EMC regulations.</p>

Voltage, current, frequency and protection are marked on the *Type plate*. The voltage tolerance is $\pm 10\%$.

- ↓ For machines which have not been pre-wired by VIRTUS , the electrical connection is to be carried out in accordance with the enclosed *Wiring diagram* in the terminal box. When doing this, the regulations of the local electricity authority are to be adhered to. The cable cross section required is to be determined according to the rated capacity of the units.

 WARNING	
	<p>When operating specific equipment caution must be taken to prevent electrical shock. Installation, service, alterations and or modifications must only be done by qualified personal and with high regard for safety. Not conforming to the requirements could result in bodily injury, death or costly damage.</p>

HINT



Alterations to the wiring diagrams from VIRTUS require our approval. Failure to do this will exclude all guarantee claims.

The wiring schematics are located in the control panel in the event that the control panel is a part of the delivery.

Connection of Emergency Stop button

The machine may only be operated with installed Emergency Stop buttons. In the case that no Emergency Stop buttons have been installed at the factory, an Emergency Stop button must be installed at the control cabinet, the second at the grinding material in feed.



HINT

The control panel with the switches and Emergency Stop button should be installed nearby the machine. The distance should not exceed 5 m.

The connecting cables between control panel and machine have to be protected against damage (cable tray, protective sleeve).

If the control box cannot be installed according to this rules an additional Emergency Stop button has to be installed on the machine.

Checking the rotational direction

Rotational direction of the motors must be checked before initial start-up (see chapter of same name). The steps prior to this check must be completed.

- ↓ Switch the machine on and then immediately off again (see *Switch on machine* and *Switch off machine*).
- ↓ Observe whether the discharge air fan in the drive motor is rotating in the direction of the direction arrow.



HINT

If running in the wrong direction, reconnect the motor connection immediately. Damage to the machine will result from operation in the wrong direction.

PART A: Basic machine

Shredder

L 60; L85

6.5 Machine check prior to initial start-up

Check	See chapter
1. When housing flap is opened, check the knife mounting screws using a torque wrench.	<i>Replacing and checking the cutting knife mountings.</i>
2. Search the grinding chamber for foreign matter.	<i>Cleaning the machine</i>
3. Check oil level of the gear box motor	<i>motor Maintenance</i>
4. Examine in feed device (accessories) for foreign matter.	<i>Part B: Accessories.</i>
5. Check that the <i>Emergency Stop buttons</i> are unlocked.	
6. Check all safety devices for proper functioning.	<i>Checking the protective devices.</i>
7. Switch on machine for a short time and check rotational direction. The rotational direction can be seen at the discharge air fan of the drive motor (observe running direction arrow).	<i>Electrical connection.</i>
8. Allow machine to run for approx. 10 minutes without grinding material.	<i>Switch on machine.</i>
9. Connect material discharge device (accessories) and in feed device (accessories), check rotational direction drives.	<i>Part B: Accessories.</i>
10. Feed grinding material uniformly. Too much grinding material can lead to overload of the machine.	<i>Manual in feed of grinding material.</i>
11. If necessary, check the temperature of the ground material.	
12. Monitor the ammeter. This displays the present current consumption and in this way gives information on the load of the machine.	

7 OPERATION

**Have you read and understood the operation manual, in particular the safety advice in the Chapter Four?
You may not operate the machine until you have done so!**

TIP



Should faults occur during work with the machine, please observe the advice in the chapter *Error! Reference source not found.*

7.1 Machine checks before switching on the machine

Check	See
1. The knives are properly set and the screws are tightened with the specified torque.	<i>Replacing and checking the cutting knife mountings.</i>
2. The grinding chamber is free of foreign matter.	<i>Cleaning the machine.</i>
3. The housing flaps are closed.	
4. All safety devices, including those of the installed grinding material in feed and discharge devices, are checked and operative.	<i>Checking the protective devices.</i>



7.2 Switch on machine

1. Switch on the grinding material discharge device.
2. Switch on the Shredder (main switch to 1). Wait until the rotor has reached its full speed.
3. Switch on the grinding material in feed device (accessories).

7.3 Switch off machine

1. Switch off the grinding material in feed device (accessories).
2. Wait until the remaining grinding material has been ground, and then switch off the shredder, (main switch to 0).
3. Switch off the grinding material discharge device.



7.4 Manual in feed of grinding material

 DANGER	
	<p>Rotating knives. Can cause serious cutting and crushing injuries, possibly leading to death. Do not reach into the in feed hopper or lean in whilst the rotor is running (pay attention to the run down time). Only use approved grinding material.</p>

↓ Throw the grinding material into the in feed hopper.

The machine should be feed from the front.



If in your design of machine an additional in feed device is installed, please observe the additional information for work with and on the in feed device *Part B: Accessories*.

 DANGER	
	<p>Do not climb into the in feed hopper while operating the machine. You will die.</p>

8 MAINTENANCE

8.1 Safety advice

Trained specialist personnel may only carry out work included within the framework of maintenance. Carry out the maintenance work within the specified time and document this. The machine will thank you for this by providing high reliability.

 WARNING	
	Danger caused by electrical voltage and starting the machine during maintenance work. Mortal danger.
	Therefore, as a basic rule when carrying out maintenance work: Main switch to 0, safeguard using padlock and attach a warning sign.

8.2 Maintenance plan

The tasks for maintenance work are described in detail in this chapter.

Maintenance work	Oh = Operation hours		
	Every Day	Every Week	Every Month
Check protective devices for proper functioning.	x		
Clean machine.			x
Check cutting knife mountings.	x		
Check the main bearings (bearing clearance, lubricant renewal).			x
Lubricant replacement, lubricant renewal	See <i>Lubrication intervals</i>:		
Check condition of cutting knives.	x		
Check all screws of the machine for a tight fit.		X	
Check wearing parts.		X	
Check hydraulic oil level and consistence		X	
Check gearbox motor oil level		Every 2000 Oh	

Yearly maintenance



The purpose of yearly maintenance of the machine is primarily to check the general condition of the machine and to arrange for the supply of any necessary replacement parts in good time. A service engineer from VIRTUS EQUIPMENT can also carry this out on request.

8.3 Checking the protective devices



For this, see also the chapter *Protective devices*.

Check the safety devices for:

- Stipulated condition,
- Stipulated location,
- Safe mounting,
- Stipulated function.



 WARNING	
	<p>Danger due to non-functioning protective devices. Serious injury or death can result.</p> <ul style="list-style-type: none">• Eliminate all defects before you put the machine into operation!• If defects occur during operation, stop the machine immediately and eliminate the defects!• Do not change or remove any protective devices. Do not put any protective devices out of action by modifying them.

8.4 Cleaning the machine

 WARNING	
	<p>Danger of cutting caused by sharp cutting knives, even when the rotor is at a standstill. Serious injury, particularly to hands and fingers, can result. Wear protective gloves.</p>

Proceed as follows:

- ↓ Switch off the shredder at the main switch
- ↓ Safeguard main switch using a padlock.
- ↓ Open the housing flaps.
- ↓ Safeguard the housing flap.
- ↓ Remove the screen
- ↓ Empty the screen

 WARNING	
	<p>Inhalation of grinding dust which is dangerous to the health. This can result in injury to the respiratory tract. Never blow out the grinding material residue, use suction instead. Wear breathing protection if necessary.</p>

- ↓ Pre-clean the grinding chamber using a hand brush.
- ↓ Suck up the remaining grinding material residue using a suitable suction device.
- ↓ Remove clinging grinding material residue using a suitable wooden scraper.
- ↓ Put the screen back into its working position and fasten with the mounting screws
- ↓ Close the housing flaps
- ↓ Machine can be started again

8.5 Replacing the gearbox motor

The gearbox motor is dimensioned so that a replacement is only necessary in exceptional cases. Dismounting and mounting of the gear box requires specialist knowledge and a careful working method. Therefore, please observe the instructions given in the installation manual of the gear box manufacturer or ask the VIRTUS service department for help.

8.6 Replacing the rotor

The rotor is a heavy duty design so that a replacement is only necessary after a crash, e.g. a hammer fall inside. Dismounting and mounting of the rotor requires specialist knowledge and a careful working method.

8.6.1 Dismounting the rotor

To dismount the rotor proceed as follows:

The parts which are marked with a part number are illustrated in the drawings of the spare parts list!

- ↓ Dismount the gearbox motor (*see Replace the gearbox motor*)
- ↓ Remove the rotor mounting slot cover plates from the housing.
- ↓ Screw in hooks on both shaft ends.
- ↓ Hang on rotor on both shaft ends.
- ↓ Remove the bearing housing fixing bolt.
- ↓ Carefully lift out the complete rotor using suitable lifting and stopping means.
- ↓ Lay the rotor down in a safe location. Suitable for this are timber beams of appropriate size.

8.6.2 Mounting the rotor

To mount the rotor proceed as follows:

- ↓ Before mounting, clean the bearing seat surfaces and check the key.



HINT

- If the spare rotor is delivered without bearings, the bearings have to be mounted first(see Mounting the main bearings)

- ↓ Lift the rotor using suitable lifting and stopping equipment and put carefully into the bearing seats.
- ↓ Attach the bearing housing (Pos) to the bearing seats using screws.
- ↓ Put the gearbox motor onto the rotor axis
- ↓ Put back the rotor mounting slot cover plates
- ↓ Carry out a test run.

8.7 Replacing the main bearings

The main bearings of the machine are dimensioned so that a bearing replacement is only necessary in exceptional cases. Dismounting and mounting of the bearings requires specialist knowledge and a careful working method. Therefore, in addition to the following advice, please observe the instructions given in the installation manual of the bearing manufacturer or ask the VIRTUS service department for help.

The bearings mounted in this machine are indicated in the spare parts list. A requirement for dismounting and mounting the bearings is a suitable pulling-off device.

8.7.1 Dismounting the main bearings

To dismount the bearings proceed as follows:

- ↓ Dismount the gearbox motor(see *Replace the gearboxmotor*)
- ↓ Pull the distance sleeve off the rotor axis.
- ↓ Remove the rotor cover plates from the housing.
- ↓ Screw in hooks on both shaft ends.
- ↓ Hang on rotor on both shaft ends.
- ↓ Remove the bearing housing fixing bolt.
- ↓ Carefully lift out the complete rotor using suitable lifting and stopping means.
- ↓ Lay the rotor down in a safe location. Suitable for this are timber beams of appropriate size.
- ↓ Loose the bearings cover mounting screws and take off the bearing cover.
- ↓ Pull the bearing housing off with a pulling-off device.
- ↓ Pull the bearing off the rotor axis using a pulling-off device.

8.7.2 Mounting the main bearing

To mount the bearings proceed as follows:

- ↓ Before mounting, clean the bearing surfaces and the shaft surfaces thoroughly and grease lightly.
- ↓ Mount bearing in bearing housing.
- ↓ Attach the bearing with the bearing housing to the rotor axis.

HINT



- During mounting, the mounting forces must always engage into the inner ring, otherwise the roller bodies will be damaged.
 - The hardened bearing rings are sensitive to impact stress. For this reason, never hit directly on the rings with the hammer, use instead preferably a brass arbor or better still a striking bushing (piping piece) made from a soft material. The inner diameter of the striking bushing should be only slightly larger than the diameter of the bearing base.
 - The bearing is then pushed onto the shaft using light blows. When doing this, the force of pressure must be evenly distributed on the circumference of the bearing ring.
- ↓ Lift the rotor using suitable lifting and stopping equipment and place carefully into the bearing seats
 - ↓ Attach the bearing housing to the bearing seats using screws.
 - ↓ Push the distance sleeve onto the rotor axis.
 - ↓ Put the gearbox motor onto the rotor axis
 - ↓ Put back the rotor cover plates
 - ↓ Carry out a test run.

8.8 Lubricating the main bearings

An important requirement for high operational safety and long service life of the arrangement of bearings is the correct lubricant supply. Every VIRTUS machine is greased and checked in test runs before delivery.

HINT



Unsuitable lubricant, lubricant deficiency, excessive lubrication or impurities in the lubricant lead to overheating and thus extreme wear of the bearings.

8.8.1 Lubrication intervals:

Shift operation	Replace lubricant	Check
One shift operation:	every 18 months	monthly
Two shift operation:	every 9 months	monthly
Three shift operation:	every 6 months	monthly

8.8.2 Check lubricant quality

You can judge whether the lubricant needs to be replaced by checking for the following features:

- change in consistency,
- discolouration,
- degree of soiling.

8.8.3 Replacing or refilling lubricant

HINT



- Fill the bearings uniformly with grease, so that all operating surfaces are well greased.
- For the rotor bearings, a lubricant quantity of one third to a maximum of half of the bearing volume per bearing is required. If too much grease is filled in, the lubricant will become unusable as a result of excessive temperature.
- Only one type of grease may be used, mixing different types of grease is not allowed. The bearings have been filled at the factory with lithium base saponification roller bearing grease F3.
- To find out which lubricants from which manufacturers you can use, look in the *List of lubricants*.

Refilling lubricant

The grease reaches through the circulating grooves and bores via lubrication nipples into the interior of the bearing.
The greasing quantity is 60 to 100 g roller bearing grease F3 per bearing.

Illustration:
Grease nipple

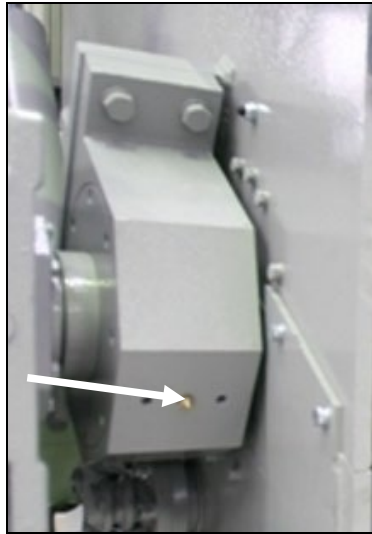

Replacing lubricant

Only in the case of unusual bearing noises or overheating is it also necessary to renew the lubricant between the specified intervals. Mounting and dismounting of the bearings is to be carried out in accordance with the instructions in this operation manual (see replacing the bearings).

- ↓ Open the bearing.
- ↓ Remove the bearing housing and the bearing cover.
- ↓ Clean the bearing carefully using petroleum ether.
Petroleum ether, petroleum, spirit, aqueous neutral or alkaline cleaning agents may be used to clean the bearings. After washing out, the bearing must immediately be preserved using lubricant, in order to avoid corrosion.
- ↓ Fill bearing with approved lubricant (see *List of lubricants*).

**PART A: Basic machine
Shredder
L 60; L85**

8.8.4 List of lubricants

Country of manufacture / manufacturer	Roller bearing grease
ARAL	ARAL Grease HL 3
BP	BP ENERGREASE LS 3
CASTROL	CASTROL SPHEEROL AP 3
ESSO	Beacon 3
FUCHS	FUCHS Grease 1200 FUCHS Grease FWA 220
SHELL	SHELL Alvania Grease 3
MOBIL-OIL	MOBILUX 3
WISURA	WISURA Liba L 3
Zeller & Gmelin	ZET GE Grease M 50
FAG	FAG L 71
ANTAR Petroles de l'Atlantique	ROLEXA
Holland, Beverol	Beverol Multi Purpose Grease
Italy, Agip	AGIP Grease 33 FD
Swede, NYNÄS	Nynäs FI 3-42

8.9 Working on the cutting knives

In the case of shredders, the correct grinding properties, correct setting and mounting of the cutting knives are important factors to ensure perfect functioning and economic operation of the machine.

8.9.1 Replacing and checking the cutting knife mountings

Due to their function, certain machine parts are subject to stress in their operating state as a result of vibrations, which can lead to loosening of the screw connections. Therefore, it is absolutely necessary to check the cutting knife mounting screws in accordance with the *Maintenance plan*.



- ↓ Tighten the mounting screws on the cutting knives using a torque wrench which is set to the required torque for the screw size.
The required torque for the knife fixing bolts is 120 Nm.

You can find out the required torque from the following table. Take note too that the tightening capacity decreases of screws which have been loosened and tightened again several times. New screws of the same material quality must therefore replace the cutting knife mounting screws after they have been loosened and tightened several times.

Torque:

Bolt type	Grade 8.8		Grade 10.9		Grade 12.9	
	Nm	lbf ft	Nm	lbf ft	Nm	lbf ft
M8	25	18.4	35	25.8	41	30.2
M10	49	36.1	69	50.9	83	61.2
M12	86	63.4	120	88.5	145	106
M16	210	154	295	217	355	261
M20	410	302	580	428	690	508
M24	710	523	1000	737	1200	885

8.9.2 Checking the condition of the cutting knives

 WARNING	
	<p>Danger of cutting caused by sharp knives, even when the rotor is at a standstill. Serious injury, particularly to hands and fingers, can result. Wear protective gloves.</p>

The cutting knives become blunt after a certain number of operation hours. Therefore they should be checked regularly.

Using blunt knives has the following consequences:

- Decreased grinding capacity.
- Increased current consumption of the drive motor.
- Inexact cut.
- Overheating of the ground material.

PART A: Basic machine
Shredder
L 60; L85

8.9.3 Dismounting the rotor knives

⚠ WARNING	
	Danger of cutting caused by sharp knives, even when the rotor is at a standstill. Serious injury, particularly to hands and fingers, can result. Wear protective gloves.

Proceed as follows:

Illustration:

- (1) Rotor knife
- (2) Knife mounting screw
- (3) Knife holder
- (4) Knife holder mounting screws

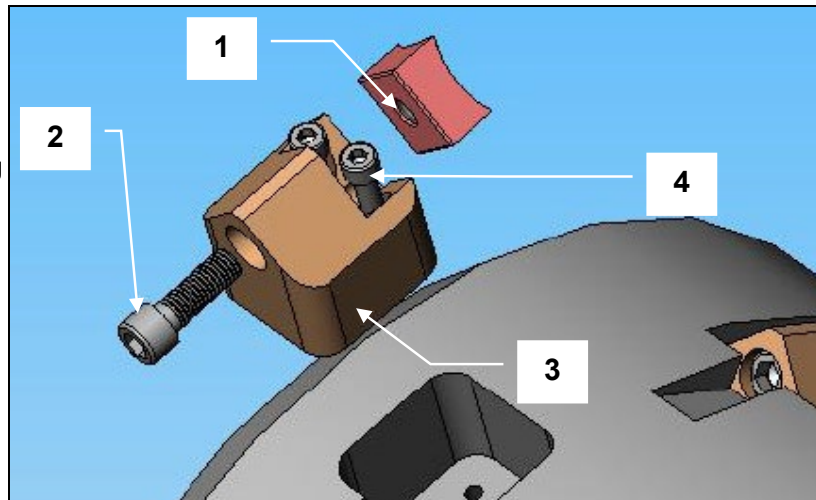

- ↓ Switch off the shredder at the main switch
- ↓ Safeguard main switch using a padlock.
- ↓ Open the lower housing flap.
- ↓ Safeguard the housing flap.
- ↓ Remove screen

Although it is possible to reach the cutting shaft by climbing into the feeding chamber, we recommend accessing the knives through the front side door. The shaft can be rotated manually by turning the motor v-belt pulley.

-
- ↓ Clean the hexagon head socket of the knife fixing bolt (2).
- ↓ Loose the bolt using a high quality Allen key (10 mm). If necessary knock the Allen key lightly with a hammer to loose it.
- ↓ Take out the knife fixing bolt, the washer and the knife

PART A: Basic machine
Shredder
L 60; L85

8.9.4 Dismounting the rotor knife holders

⚠ WARNING	
	Danger of cutting caused by sharp knives, even when the rotor is at a standstill. Serious injury, particularly to hands and fingers, can result. Wear protective gloves.

Proceed as follows:

Illustration:

- (1) Rotor knife
- (2) Knife mounting screw
- (3) Knife holder
- (4) Knife holder mounting screws

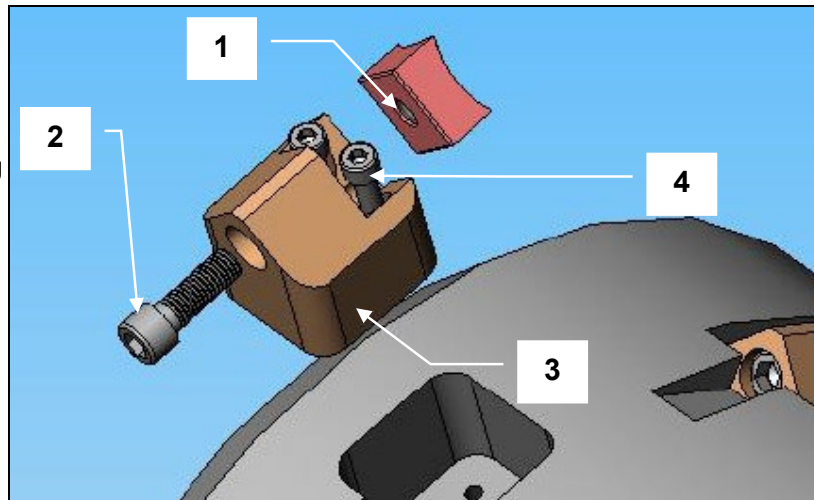

- ↓ Switch off the shredder at the main switch
- ↓ Safeguard main switch using a padlock.
- ↓ Open the lower housing flap.
- ↓ Safeguard the housing flap.
- ↓ Remove screen

Although it is possible to reach the cutting shaft by climbing into the feeding chamber, we recommend accessing the knives through the front side door. The shaft can be rotated manually by turning the motor v-belt pulley.

-
- ↓ Clean the hexagon head socket of the knife fixing bolt (2).
- ↓ Loose the bolt using a high quality Allen key (10 mm). If necessary knock the Allen key lightly with a hammer to loose it.
- ↓ Take out the knife fixing bolt, the washer and the knife
- ↓ Clean the hexagon head socket of the knife holder fixing bolts (4).
- ↓ Loose the bolt using a high quality Allen key (6 mm). If necessary knock the Allen key lightly with a hammer to loose it.
- ↓ Take out the knife holder fixing bolts.
- ↓ Remove the knife holder with the delivered Extractor.

PART A: Basic machine
Shredder
L 60; L85

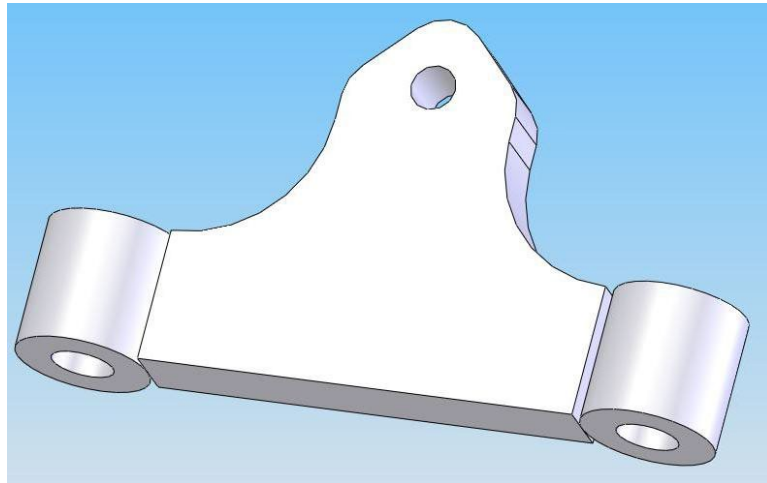

**PART A: Basic machine
Shredder
L 60; L85**

8.9.5 Dismounting the stator knives

! WARNING	
	Danger of cutting caused by sharp knives, even when the rotor is at a standstill. Serious injury, particularly to hands and fingers, can result. Wear protective gloves.

Proceed as follows:

Illustration:

- (1) Stator knife
- (2) Knife holder
- (3) Knife holder fixing screws
- (4) Knife adjusting screw for pushing
- (5) Knife adjusting screw for pulling
- (6) Cover plates
- (7) Cover plate fixing screws
- (8) Cover plate holder fixing screws
- (9) Cover plate holder

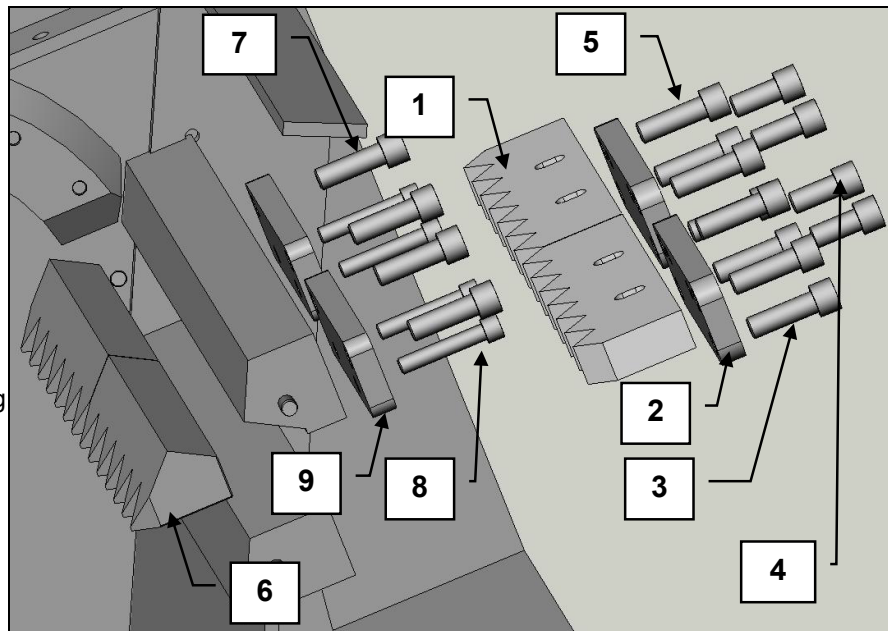



- ↓ Switch off the shredder at the main switch
- ↓ Safeguard main switch using a padlock.
- ↓ Open the upper housing flap.
- ↓ Safeguard the housing flap.

Although it is possible to reach the knives by climbing into the feeding chamber, we recommend accessing the knives through the front side door.

- ↓ Clean the hexagon head socket of the knife fixing bolts (2) and the cover plates fixing bolts.
- ↓ Loose the cover plate fixing bolts using a high quality Allen key (10 mm). If necessary knock the Allen key lightly with a hammer to loose it.
- ↓ Take out the bolts and the cover plates
- ↓ Loose the knife adjusting screws for pulling and take them out
Loose the knife fixing bolts using a high quality Allen key (10 mm).
If necessary knock the Allen key lightly with a hammer to loose it.
- ↓ Take out the knife fixing bolt, and the knife

8.9.6 Mounting the rotor knife holders

 WARNING	
	<p>Danger of cutting caused by sharp knives, even when the rotor is at a standstill. Serious injury, particularly to hands and fingers, can result. Wear protective gloves.</p>

Proceed as follows:



- ↓ Clean the knife pocket and the knife holder
- ↓ Insert knife holder into the pocket

Knife holder must slide in easily. Do not damage the knife holder surfaces using a hammer.

- ↓ Put in the knife holder fixing bolts (DIN912 – M8x25 – 12.9) and put some Loctite on them.
- ↓ **Make sure that the knife holder fits properly.**
- ↓ Tighten the knife fixing bolts using a torque wrench.

The required torque for the knife holder mounting bolts is 39 Nm (also see the table under *Replacing and checking the cutting knife mountings*).

8.9.7 Mounting the rotor knives

 WARNING	
	<p>Danger of cutting caused by sharp knives, even when the rotor is at a standstill. Serious injury, particularly to hands and fingers, can result. Wear protective gloves.</p>



HINT

The cutting knives, in particular the rotor knives, should only be sharpened or replaced in sets. There is a danger of balance error if a combination of rotor knives from different knife sets is used.

Proceed as follows:

- ↓ Clean the knife supporting surface and the hole on the knife holder
- ↓ Insert sharp knife or turn old knife and push against the knife holder surface.
- ↓ Put in the knife fixing bolt (DIN912 – M12x40 – 12.9) and the washer (DIN433 – 13 – 300HV).
- ↓ Screw in the mounting screws and tighten lightly first
- ↓ **Make sure that the knife fits planar in the seat**
- ↓ Tighten the knife fixing bolts using a torque wrench.

The required torque for all knife mounting bolts is 120 Nm (also see the table under *Replacing and checking the cutting knife mountings*).

- ↓ **Check whether the cutting gap is correct and whether the cutting knives do not collide as the rotor turns.**

TIP



Rotor knives from VIRTUS are reversible and have four symmetrical cutting edges.
This makes it possible to turn the knives and only to sharpen after every fourth knife change.

- ↓ Remove tools and other objects from the cutting chamber.
- ↓ Put back screen and fix it
- ↓ Switch on the shredder for a short time without grinding material and listen for noises. If you hear unusual noises, determine the cause and eliminate it.

PART A: Basic machine
Shredder
L 60; L85

8.9.8 Mounting the stator knives

! WARNING	
	Danger of cutting caused by sharp knives, even when the rotor is at a standstill. Serious injury, particularly to hands and fingers, can result. Wear protective gloves.

Proceed as follows:

Illustration:

- (1) Stator knife
- (2) Knife holder
- (3) Knife holder fixing screws
- (4) Knife adjusting screw for pushing
- (5) Knife adjusting screw for pulling
- (6) Cover plates
- (7) Cover plate fixing screws
- (8) Cover plate holder fixing screws
- (9) Cover plate holder

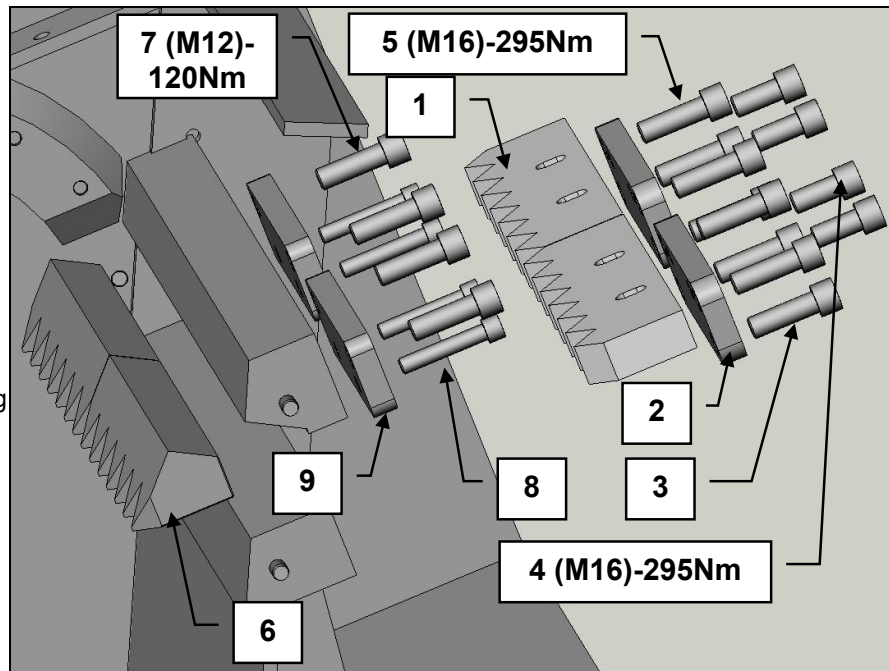

- ↓ Remove old knives (see *dismounting the stator knives*)
- ↓ Insert sharp knife or turn old knife.
- ↓ Put in the knife adjusting bolts for pushing and adjust them roughly
- ↓ Put in the knife adjusting bolts for pulling and tighten lightly first

Adjust the gap between rotor and stator knife to 0.8-1.0 mm by using the adjusting bolts.

- ↓ Tighten constant both knife adjusting bolts for pulling by using a torque wrench.
- ↓ Tighten constant both knife adjusting bolts for pushing by using a torque wrench.

The required torque for all knife mounting bolts M12 is 120Nm
The required torque for all knife adjusting bolts M16 is 295Nm
(also see the table under Replacing and checking the cutting knife mountings).

- ↓ Turn the rotor by hand

- ↓ Check whether the cutting gap is correct and whether the cutting knives do not collide as the rotor turns.



TIP

Stator knives from VIRTUS are reversible and have two symmetrical cutting edges.

This makes it possible to turn the knives and only to sharpen after every second knife change.

- ↓ Put back the cover plates and fix them with the bolts
- ↓ Remove tools and other objects from the cutting chamber.
- ↓ Put back screen and fix it.
- ↓ Switch on the shredder for a short time without grinding material and listen for noises. If you hear unusual noises, determine the cause and eliminate it.

PART A: Basic machine

Shredder

L 60; L85



8.9.9 Sharpening cutting knives

Shredder rotor knives from VIRTUS have four cutting edges. This means they can be turned three times. After that they should be replaced with new ones. Stator knives can be turned two times and can be resharpened as long as you can fix them with the long hole.

TIP



Specialist sharpening of the cutting knives is part of the service offer of VIRTUS .

 WARNING	
	Danger of cutting caused by sharp knives, even when the rotor is at a standstill. Serious injury, particularly to hands and fingers, can result. Wear protective gloves.

HINT





The cutting knives, in particular the rotor knives, should only be sharpened or replaced in sets. There is a danger of balance error if a combination of rotor knives from different knife sets is used.

Proceed as follows:

- ↓ Dismount the cutting knives (see *Dismounting the rotor knives*).
- ↓ Sharpen the cutting knives.
A specialist in accordance with the sharpening plan using particular care should uniformly sharpen the cutting knives mechanically. It is important to make sure that sharpening takes place with small grinding allowance and sufficient coolant supply. The sharpening process is finished when the cutting edge is sharply cut. Not all indentations must be ground out, otherwise the number of possibilities for sharpening is unnecessarily reduced. For the sharpening process, use soft grinding wheels (Quality 40 H or 46 K). Knives, which have grinding cracks, are not to be reused due to danger of breakage during operation.
- ↓ Whet the cutting edges of the cutting knives using a whetstone.
By taking these measures, the service life of the cutting knives can be increased.
- ↓ Set the cutting knives (see *setting the cutting knives*).
- ↓ Mount the cutting knives (see *mounting the stator knives*).

PART A: Basic machine
Shredder
L 60; L85

8.9.10 Setting the cutting knives

 WARNING	
	<p>Danger of cutting caused by sharp cutting knives. Serious injury, in particular to hands and fingers, can result. Wear protective gloves.</p>

Rotor knives for the L series shredder don't have to be adjusted. All adjustments have to be done with the stator knives. To simplify knife setting and shorten standstill periods when replacing the knives, VIRTUS stator knives have four adjusting screws, two for pulling two for pushing the knife. If you have several knife sets, you will also avoid standstill periods of the machine. Correct and careful setting of the gap between the rotor knives and the stator knives (cutting gap) is an important requirement for the productive capacity of the shredder. Factors for the size of the knife gap are the size of the rotor, the design of the rotor and the material to be ground.

For setting the knives, proceed as follows:

Illustration:

- (10)Stator knife
- (11)Knife holder
- (12)Knife holder fixing screws
- (13)Knife adjusting screw for pushing
- (14)Knife adjusting screw for pulling
- (15)Cover plates
- (16)Cover plate fixing screws
- (17)Cover plate holder fixing screws
- (18)Cover plate holder

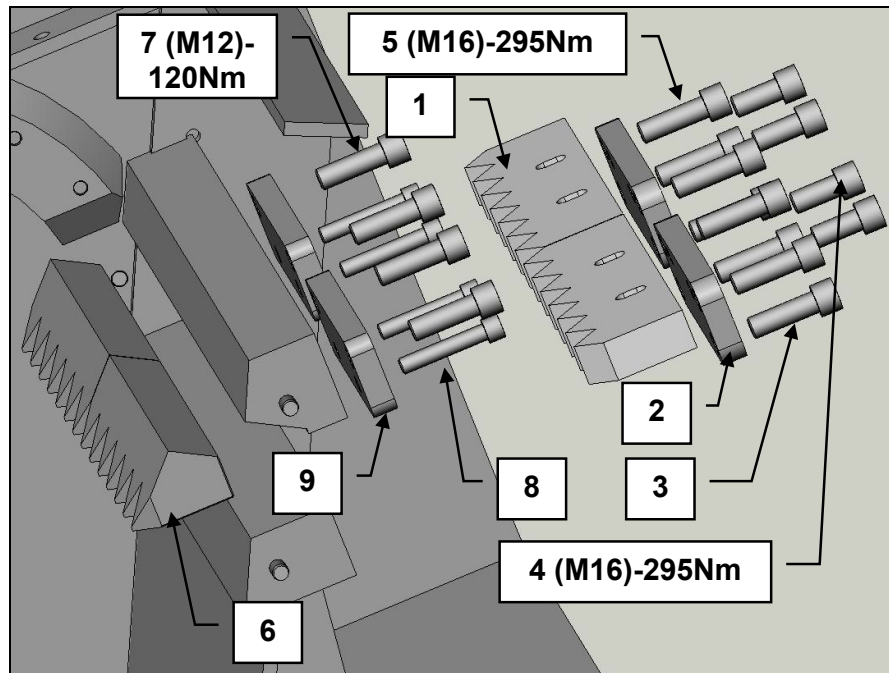

- ↓ Remove old knives (see *dismounting the stator knives*)
- ↓ Insert sharp knife or turn old knife.
- ↓ Put in the knife adjusting bolts for pushing and adjust them roughly

PART A: Basic machine

Shredder

L 60; L85

- ↓ Put in the knife adjusting bolts for pulling and tighten lightly first
- ↓ Adjust the gap between rotor and stator knife to 0.8-1.0 mm by using the adjusting bolts.
- ↓ Tighten constant both knife adjusting bolts for pulling by using a torque wrench.
- ↓ Tighten constant both knife adjusting bolts for pushing by using a torque wrench.



The required torque for all knife mounting bolts M12 is 120Nm
The required torque for all knife adjusting bolts M16 is 295Nm
(also see the table under Replacing and checking the cutting knife mountings).

- ↓ Turn the rotor by hand
- ↓ **Check whether the cutting gap is correct and whether the cutting knives do not collide as the rotor turns.**

Recommended knife gap: 0.8 mm – 1 mm

- ↓ Fix the knife cover plates

8.9.11 Transporting and storing the cutting knives

 WARNING	
	<p>Danger of cutting caused by sharp cutting knives. Serious injury, in particular to hands and fingers, can result. Wear protective gloves.</p> <p>Only transport and store the cutting knives packaged. Grease the cutting knives well, so that they do not rust. Protect the cutting edges with doubled cardboard and use adhesive tape to safeguard the knives against slipping out of the sides of the sheath.</p> <p>After unpacking, you must degrease the cutting knives so that they can be gripped safely.</p>

9 TROUBLESHOOTING

9.1 Machine blocks or switches itself off

No.	Possible causes	Remedy required
9.1.1	Too much feed material.	Reduce grinding material in feed.
9.1.2	Knife condition.	Check knives and sharpen or replace if needed.
9.1.3	Cutting gap.	Check cutting gap and set according to the instructions in this operation manual.
9.1.4	Discharge blocked.	Check if discharge conveyor belt is running
9.1.5	Current failure.	Check limit switch for defective contact. Check electrical connection, if necessary tighten limit switch.
9.1.6	Fuse too small.	Fit larger fuse. Only after consulting the service department of VIRTUS .
9.1.7	Rotational direction of rotor.	Check motor and reverse polarity if necessary.
9.1.8	Rotor speed.	Change rotor speed. Only after consulting the service department of VIRTUS .

9.2 Rotor does not grip bulky material

No.	Possible causes	Remedy required
9.2.1	Knife condition.	Check and sharpen if needed according to the instructions in this operation manual.
9.2.2	Protruding bed knife.	Chamfer bed knives; consult with service department of VIRTUS .
9.2.3	Knives not aggressive enough	Fit underlay plates below the knife holders

9.3 Overheating of the grinding material

No.	Possible causes	Remedy required
9.3.1	See 9.1.1 to 9.1.5.	See 9.1.1 to 9.1.5.
9.3.2	Knives wrongly sharpened.	Modify knife finish. Only after consulting the service department of VIRTUS .
9.3.3	Material rubs against the housing wall.	Fit anti-winding device.
9.3.4	Insufficient cooling.	Fit rotor cooling

9.4 Unusual vibrations

No.	Possible causes	Remedy required
9.4.1	Rotor out of balance.	Weigh knives, balance rotor.
9.4.2	Bearing damage.	Check bearings, replace bearings if necessary.
9.4.3	Anti vibration pads defective	Check mounting pads and renew these if necessary.

**PART A: Basic machine
Shredder
L 60; L85**

9.5 Extreme cutter wear

No.	Possible causes	Remedy required
9.5.1	Bearing damage.	Check bearings, replace bearings if necessary.
9.5.2	Knife finish.	Check knife and sharpen or replace if necessary.
9.5.3	Wrong cutting gap.	Check cutting gap and set according to the instructions in this operation manual.
9.5.4	Foreign matter.	Fit feed device with a metal detector.

9.6 Bearings too hot

No.	Possible causes	Remedy required
9.6.1	Too much grease in bearing.	Reduce amount of grease.
9.6.2	Rubbing on housing sealing ring.	Check sealing ring, oil or replace.
9.6.3	Bearing damage.	Check bearings, replace if necessary.
9.6.4	No grease in bearing.	Lubricate bearing.

9.7 Cutting gap alters during operation

No.	Possible causes	Remedy required
9.8.1	Knife mounting screws not tight.	Retighten using torque wrench in accordance with table in operation manual.
9.8.2	Screw fatigue.	Fit new screws.
9.8.3	Washers deformed.	Insert new washers.
9.8.4	Knife holder surface deformed	Insert new knife holders
9.8.5	Supporting surfaces not clean.	Clean and de-rust supporting surfaces.
9.8.6	Threads in housing worn.	Fit new bushes in housing.

9.8 Shredder does not start

No.	Possible causes	Remedy required
9.10.1	Main and control fuses.	Replace fuse.
9.10.2	Feed device not connected.	Switch on in sequence.
9.10.3	Material jam	Empty shredder before switching on.
9.10.4	Motor protection switches off.	Check motor relay for correct setting and increase if necessary.

9.9 Shredder blocks when under load

No.	Possible causes	Remedy required
9.11.1	Feed starts too early.	Start feed only after switch over from star to delta.
9.11.2	Fuse defective.	Replace fuse. Fit larger fuse. Only after consulting the service department of VIRTUS GmbH.
9.11.3	Motor fuse switches off - red indicator.	Reduce feed quantity of the grinding material, correct setting, replace fuse.

9.10 Frequent switching off of grinding material in feed device

No.	Possible causes	Remedy required
9.12.1	Current relay switches off.	Correct setting.

10 STORAGE, DISPOSAL, TRANSPORTATION

10.1 Storage



Clean the machine (see Cleaning the machine). Preserve all polished metal surfaces using a suitable rust preventing agent. Store the machine in an enclosed, dry place. Cover the machine completely with a plastic sheet.



10.2 Disposal



Protect the environment.

The disposal of machines, machine components and process materials is partially subject to legal controls. More detailed information is given at the relevant administrative authority (e.g. regional and national Water Conservation Bureaux and Environmental Protection Agencies). Only deposit the material to be disposed of at authorized drop-off points.

10.3 Transportation

 WARNING	
	Suspended load. Falling loads can cause serious injury or death. Only use a crane or forklift truck, which is suitable for the weight and dimensions of the loads.
	Also use suitable stopping means and pay attention to the gravity centre location. Do not step under the suspended load. Wear a protective helmet in addition to your basic protective gear.

11 CUSTOMER SERVICE AND SPARE PARTS ORDERS



Should problems occur during operation of the machine or if you have general questions about the machine which this operation manual cannot answer, please do not hesitate to contact us. We would be pleased to help you further in order to solve your problem as quickly as possible.

You can identify the spare parts you require using the spare parts list. Please quote the following information when making your order so that we can deliver the spare parts to you quickly:

- Company name and address.
- Contact person.
- Machine type.
- Machine number.
- Piece number of the spare part.
- Spare part reference.
- Subject number.
- Order quantity.

Virtus Equipment
9120 Centerlinks Commerce DR., Unit 4
Fort Myers, FL 33912

Phone: +1-239-219-1500
Parts@Virtus-Equipment.com

www.Virtus-Equipment.com

TIP



The easiest way to order your spare parts is to copy the spare parts list and to fill in the order amount after the respective spare part.

**PART A: Basic machine
Shredder
L 60; L85**

12 SPARE PARTS LIST L 60

Pos.	Pc	Description/Standard	Part number/SAP
100		Machine complete	
101	1	Standard hopper	21254400
102	1	PVC curtain	21255400
103	1	Hopper frame	21255100
104	1	Cutting chamber	21250100
105	1	Manual jack	80004010
106	1	Door	21253300
107	1	Base frame	21256600
108	4	Stand	21254000
109	4	Absorber	80051547
200		Bearing	
201	2	Bearing housing	80051295
202	3	Bearing	80040482
203	3	Bearing Cover A	20322900
204	1	Bearing Cover B	21252900
205	3	Sealing	80040229
206	2	Grease nipple GB1152-89/M10x1	80012470
207	1	Bush Øxxx	21252900
208	18	Fixing bolt cover plate A DIN912-M8x25-12.9	80011090
209	6	Fixing bolt cover plate B DIN912-M8x40-12.9	80011101
210	2	Fixing bolt DIN912-M8x30-12.9	80011091
211	1	Cover plate	21252800
212	4	Fixing plate bolt DIN933-M20x70-12.9	80010180
212	4	Spring Washer DIN433 21	80040440
213	4	Washer DIN 125 – A 24	80010780
300		Drive	
301	1	Gearbox motor (Lenze)	80020437
302	1	Cover for Gearbox motor	21257700
303	3	Fixing bolt DIN933 M20x40-8.8	80010080
304	3	Spring washer DIN 127 –20	80010880
305	3	Washer DIN 125 –21 A	80010770
306	1	Cover plate	21253200
307	2	Fixing bolt DIN912 M8x50-12.9	80011121
308	1	Torque arm plate	21256700
309	1	Torque arm	21257100
310	4	Fixing bolt DIN931 M24x125-12.9	80040363
311	8	Washer DIN433-24	80040442
312	4	Spring washer DIN127-24	80040441
313	4	Fixing nut DIN934 M24-10	80040366
314	4	Fixing bolt DIN933 M16x60-12.9	80010010

PART A: Basic machine

Shredder

L 60; L85

315	8	Washer DIN433-16	80010760
316	4	Spring washer DIN127-16	80010870
317	4	Fixing nut DIN934 M16-10	80040367
318	1	Rubber bush	80051584
319	2	Copper bush	80040575
320	1	Torque arm bolt	21257600
321	1	Fixing bolt DIN933 M8x20-8.8	80009590
322	1	Washer DIN125-8	80010720
323	1	Spring washer DIN127-8	80010840
324	1	Key GB1096/79 A20x12x230	80003370
400		E-knife rotor ø387x850	
401	26	Rotor knife 34x34x20	80001003
402	26	Rotor knife holder	21702216
403	52	Knife holder fixing bolt DIN912 – M8x20–12.9	80040542
404	26	Washer D=13	80040029
405	26	Rotor knife fixing Bolt DIN912–M12x40–12.9	80011210
500		Stator knife complete	
501	2	Stator knife /Cr12Mo1V1	80050037
502	2	Mounting plate for stator knife	22973500
503	8	Fixing Bolt DIN912 M16x50 – 12.9	80011291
504	4	Stator knife adjusting bolt DIN912 M16x30 – 12.9	80040249
505	2	Stator knife cover plate	21252000
506	2	Mounting plate for cover plate	21257800
507	4	Fixing Bolt DIN912 M12x65 – 12.9	80011270
508	4	Fixing Bolt DIN912 M16x50 – 12.9	80011291
600		Electrical parts	
601	1	Control panel	
602	2	Safety switch AZ15ZVRK-1476-1	

**PART A: Basic machine
Shredder
L 60; L85**

13 SPARE PARTS LIST L 85

Pos.	Pc	Description/Standard	Part number/SAP
100		Machine complete	
101	1	Standard hopper	21254400
102	1	PVC curtain	21255400
103	1	Hopper frame	21255100
104	1	Cutting chamber	21250100
105	1	Manual jack	80004010
106	1	Door	21253300
107	1	Base frame	21256600
108	4	Stand	21254000
109	4	Absorber	80051547
200		Bearing	
201	2	Bearing housing	80051295
202	3	Bearing	80040482
203	3	Bearing Cover A	20322900
204	1	Bearing Cover B	21252900
205	3	Sealing	80040229
206	2	Grease nipple GB1152-89/M10x1	80012470
207	1	Bush Øxxx	21252900
208	18	Fixing bolt cover plate A DIN912-M8x25-12.9	80011090
209	6	Fixing bolt cover plate B DIN912-M8x40-12.9	80011101
210	2	Fixing bolt DIN912-M8x30-12.9	80011091
211	1	Cover plate	21252800
212	4	Fixing plate bolt DIN933-M20x70-12.9	80010180
212	4	Spring Washer DIN433 21	80040440
213	4	Washer DIN 125 – A 24	80010780
300		Drive	
301	1	Gearbox motor (Lenze)	80020437
302	1	Cover for Gearbox motor	21257700
303	3	Fixing bolt DIN933 M20x40-8.8	80010080
304	3	Spring washer DIN 127 –20	80010880
305	3	Washer DIN 125 –21 A	80010770
306	1	Cover plate	21253200
307	2	Fixing bolt DIN912 M8x50-12.9	80011121
308	1	Torque arm plate	21256700
309	1	Torque arm	21257100
310	4	Fixing bolt DIN931 M24x125-12.9	80040363
311	8	Washer DIN433-24	80040442
312	4	Spring washer DIN127-24	80040441
313	4	Fixing nut DIN934 M24-10	80040366
314	4	Fixing bolt DIN933 M16x60-12.9	80010010

PART A: Basic machine**Shredder****L 60; L85**

315	8	Washer DIN433-16	80010760
316	4	Spring washer DIN127-16	80010870
317	4	Fixing nut DIN934 M16-10	80040367
318	1	Rubber bush	80051584
319	2	Copper bush	80040575
320	1	Torque arm bolt	21257600
321	1	Fixing bolt DIN933 M8x20-8.8	80009590
322	1	Washer DIN125-8	80010720
323	1	Spring washer DIN127-8	80010840
324	1	Key GB1096/79 A20x12x230	80003370
400		E-knife rotor ø387x850	
401	26	Rotor knife 34x34x20	80001003
402	26	Rotor knife holder	21702216
403	52	Knife holder fixing bolt DIN912 – M8x20–12.9	80040542
404	26	Washer D=13	80040029
405	26	Rotor knife fixing Bolt DIN912–M12x40–12.9	80011210
500		Stator knife complete	
501	2	Stator knife /Cr12Mo1V1	80050037
502	2	Mounting plate for stator knife	22973500
503	8	Fixing Bolt DIN912 M16x50 – 12.9	80011291
504	4	Stator knife adjusting bolt DIN912 M16x30 – 12.9	80040249
505	2	Stator knife cover plate	21252000
506	2	Mounting plate for cover plate	21257800
507	4	Fixing Bolt DIN912 M12x65 – 12.9	80011270
508	4	Fixing Bolt DIN912 M16x50 – 12.9	80011291
600		Electrical parts	
601	1	Control panel	
602	2	Safety switch AZ15ZVRK-1476-1	

PART A: Basic machine
Shredder
L 60; L85

Illustration: L60

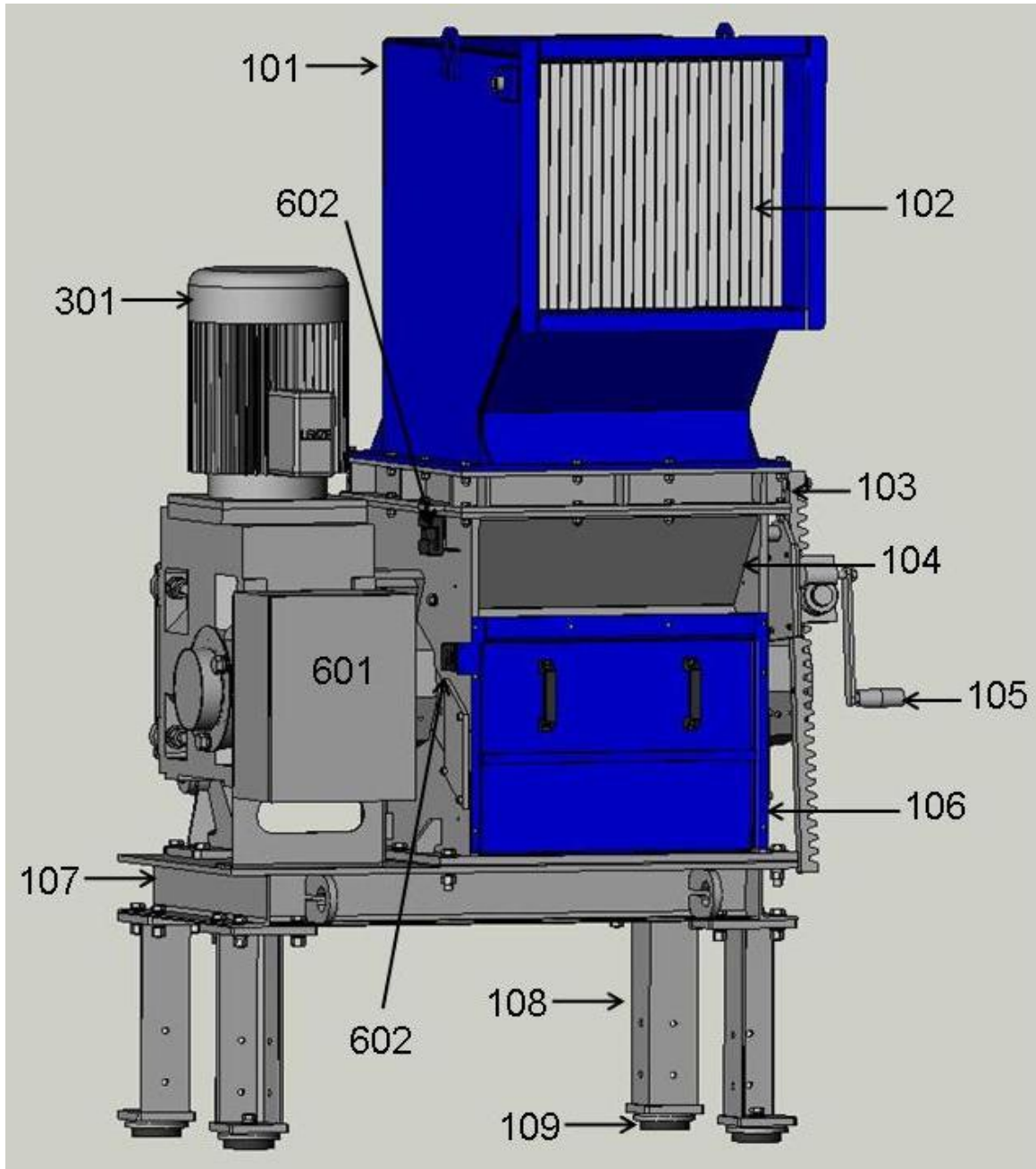

PART A: Basic machine
Shredder
L 60; L85

Illustration: Rotor knife fixing

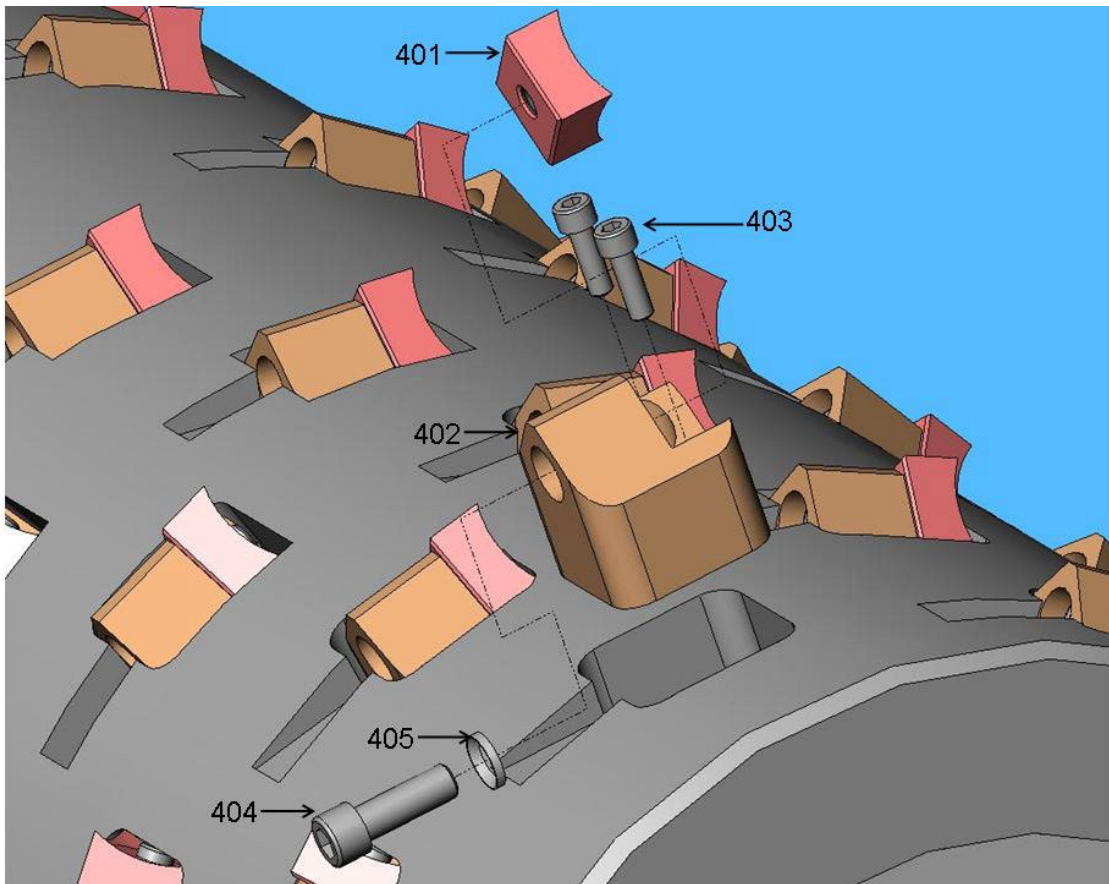

PART A: Basic machine
Shredder
L 60; L85

Illustration: Stator knife fixing

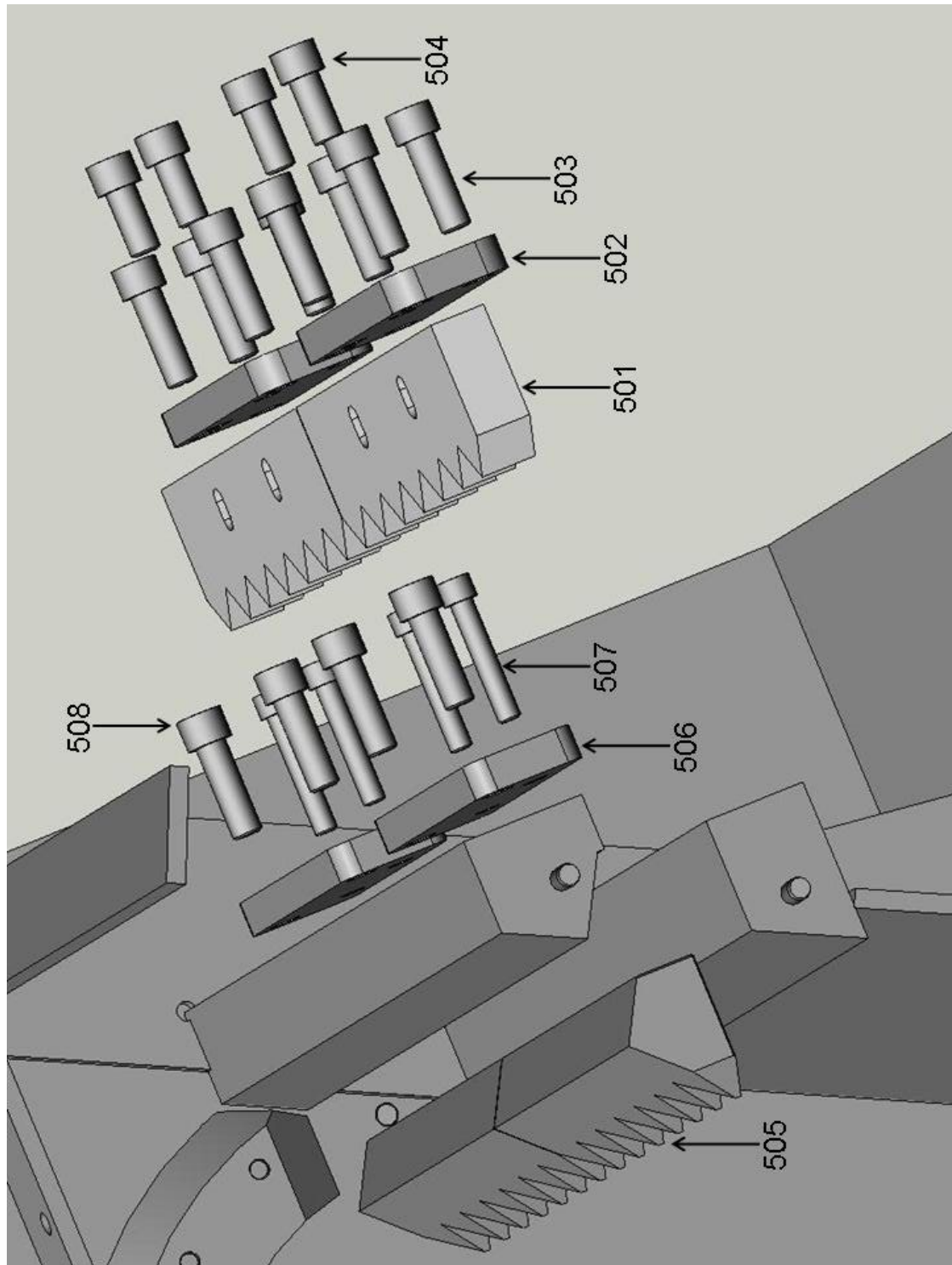

PART A: Basic machine
Shredder
L 60; L85

Illustration: Rotor assembly

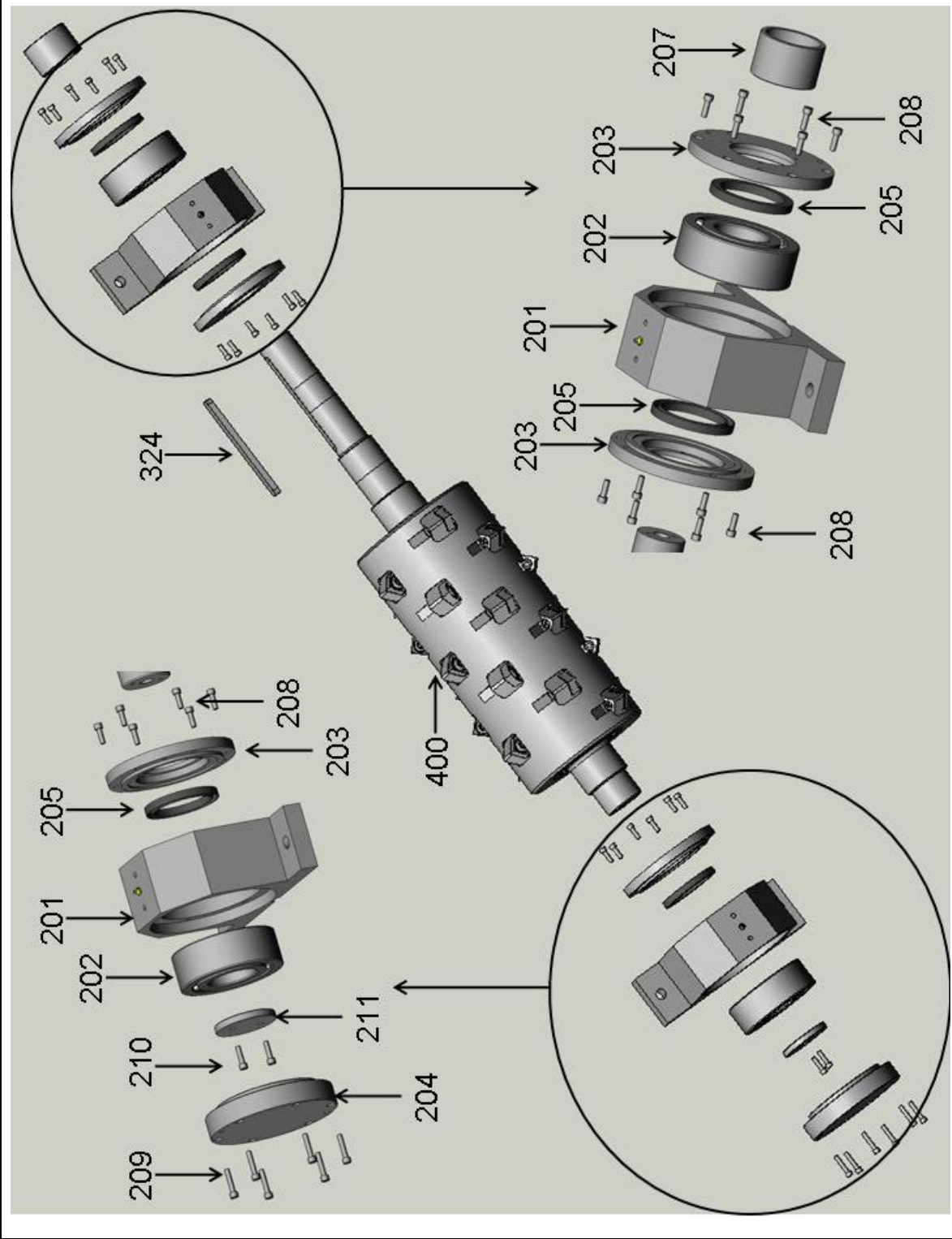

PART A: Basic machine
Shredder
L 60; L85

Illustration: Drive

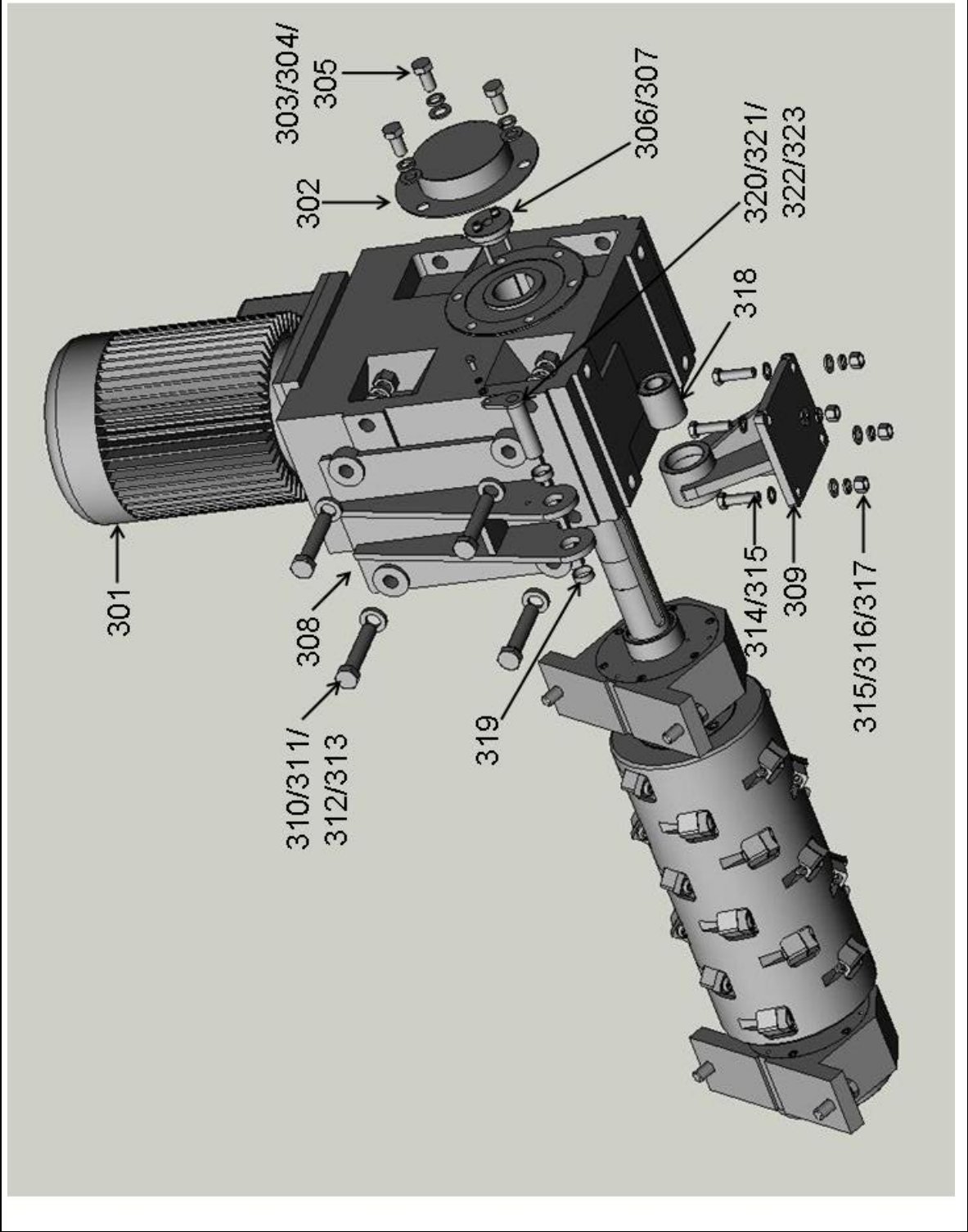

14 CLARIFICATION FOR PERSONAL TRAINING

This is to certify that I have attended an in company training for service and operation of the shredder and understand all safety regulations. Further to this I have read and understand the owners' manual.

City	Date	Printed name	Signature

15 ELECTRICAL CONNECTION

The machine should be wired by a qualified electrician.

Please refer to the wiring diagram.

PART A: Basic machine
Shredder
L 60; L85

16 DIMENSIONS OF STANDARD MACHINE

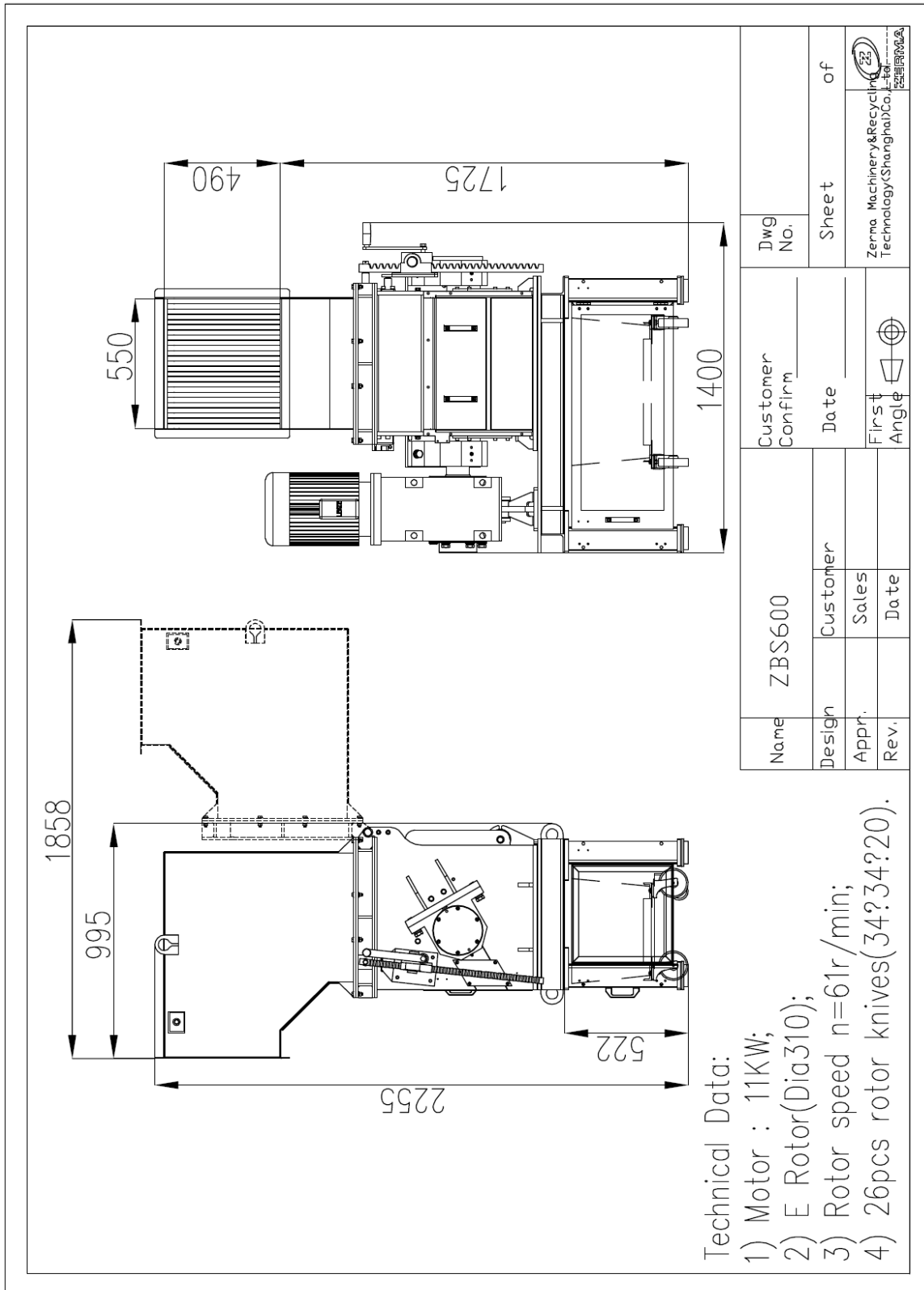



Virtus Equipment

9120 Centerlinks Commerce Dr., Unit 4
Fort Myers, FL 33912

239-219-1500

Parts@Virtus-Equipment.com

www.Virtus-Equipment.com